



FS-2100D FS-2100DN
FS-4100DN FS-4200DN
FS-4300DN

OPERATION GUIDE



This Operation Guide is for models FS-2100D, FS-2100DN, FS-4100DN, FS-4200DN and FS-4300DN.

This Operation Guide is intended to help you operate the machine correctly, perform routine maintenance and take a simple troubleshooting action as necessary, so that you can always use the machine in good condition.

We recommend the use of our own brand supplies. We will not be liable for any damage caused by the use of third party supplies in this machine.

A label shown in the illustration assures that the supplies are our own brand.

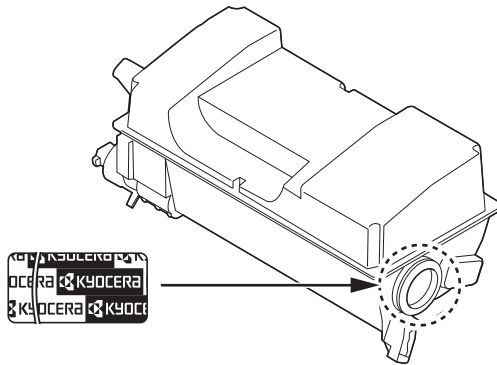

Included Guides

The following guides are supplied with the machine. Refer to them as necessary.

Quick Installation Guide	Describes the procedures for installation of the machine.
Safety Guide	Provides safety and cautionary information for the installation and use of the machine. Be sure to read this guide before using the machine.
Safety Guide (FS-2100D/ FS-2100DN/FS-4100DN/ FS-4200DN/FS-4300DN)	Describes the machine installation space, cautionary space, and other information. Be sure to read this guide before using the machine.

Product Library disc

Operation Guide (This Guide)	Describes how to load paper, basic print operations, and troubleshooting.
Command Center RX User Guide	Describes how to access the machine from a computer via a Web browser to check and change settings.
Printer Driver User Guide	Describes how to install the printer driver and use printer functionality.
KYOCERA Net Direct Print Operation Guide	Describes how to use functionality for printing PDF files without launching Adobe Acrobat or Reader.
KYOCERA Net Viewer User Guide	Describes how to monitor the network printing system with KYOCERA Net Viewer.
Card Authentication Kit (B) Operation Guide	Describes how to authenticate to the machine using the ID card.
Data Security Kit (E) Operation Guide	Describes how to install and configure the Data Security Kit.
PRESCRIBE Commands Technical Reference	Describes the native printer language (PRESCRIBE commands).
PRESCRIBE Commands Command Reference	Describes PRESCRIBE command functionality and control for each type of emulation.

Safety Conventions in This Guide

The sections of this guide and parts of the machine marked with symbols are safety warnings meant to protect the user, other individuals and surrounding objects, and ensure correct and safe usage of the machine. The symbols and their meanings are indicated below.



WARNING: Indicates that serious injury or even death may result from insufficient attention to or incorrect compliance with the related points.



CAUTION: Indicates that personal injury or mechanical damage may result from insufficient attention to or incorrect compliance with the related points.

Symbols

The \triangle symbol indicates that the related section includes safety warnings. Specific points of attention are indicated inside the symbol.



... [General warning]



... [Warning of high temperature]

The \otimes symbol indicates that the related section includes information on prohibited actions. Specifics of the prohibited action are indicated inside the symbol.



... [Warning of prohibited action]



... [Disassembly prohibited]

The \bullet symbol indicates that the related section includes information on actions which must be performed. Specifics of the required action are indicated inside the symbol.



... [Alert of required action]



... [Remove the power plug from the outlet]



... [Always connect the machine to an outlet with a ground connection]

Please contact your service representative to order a replacement if the safety warnings in this Operation Guide are illegible or if the guide itself is missing (fee required).



Note An original which resembles a bank note closely may not be copied properly in some rare cases because this machine is equipped with a counterfeiting prevention function.

Contents

Legal and Safety Information

1 Machine Parts

Components at the Front/Right of the Printer	1-2
Components at the Left of the Printer	1-2
Internal Components	1-3
Components at the Rear of the Printer	1-4
Operation Panel	1-5

2 Preparation before Use

Changing Network Interface Parameters	2-2
Printing a Status Page	2-6
Installing Software	2-7
Status Monitor	2-13
Uninstalling Software (Windows PC)	2-16
Command Center RX	2-17
Power On/Off	2-20
Energy Saver Function	2-21
Loading Paper	2-22

3 Printing

Printing from Applications	3-2
Canceling a Printing Job	3-2
Printer driver print settings screen	3-3
Registering a page size	3-4
Printer Driver Help	3-5
Changing the default printer driver settings (Windows 7)	3-5
Printing functions	3-6

4 Operation Panel

Message Display	4-2
Keys	4-4
Using the Menu Selection System	4-7
Setting a Mode Selection Menu	4-9
Report Print	4-10
USB Memory (USB memory selection)	4-17
Counter (Viewing the counter value)	4-25
Paper Settings	4-26
Print Settings	4-39
Network (Network settings)	4-54
Optional Network (Optional Network settings)	4-62
Device Common (Selecting/Setting the common device)	4-74
Security (Security function setting)	4-96
User/Job Account (User Login Setting/Job Account setting)	4-109
Adjust/Maint. (Adjust/Maintenance selection/setting)	4-128
Op Functions (Optional application settings)	4-130

5 Document Box

Document Box	5-2
Custom Box	5-4
Job Box	5-24
Computer settings (Printer driver)	5-34

6 Status Menu

Displaying the Status Menu Screen	6-2
Job Status	6-2

Job Log	6-4
USB Keyboard	6-5
Wireless Network	6-5
7 Maintenance	
Toner Container Replacement	7-2
Replacing the Waste Toner Box	7-6
Cleaning the Printer	7-8
Prolonged Non-Use and Moving of the Printer	7-10
8 Troubleshooting	
General Guidelines	8-2
Print Quality Problems	8-3
Error Messages	8-5
Clearing Paper Jams	8-17
Appendix	
Character Entry Method	A-2
About the Options	A-5
Expansion Memory Modules	A-6
General Description of Options	A-9
Paper	A-13
Specifications	A-23
Glossary	
Index	

Legal and Safety Information



CAUTION NO LIABILITY IS ASSUMED FOR ANY DAMAGE CAUSED BY IMPROPER INSTALLATION.

Notice on Software

SOFTWARE USED WITH THIS PRINTER MUST SUPPORT THE PRINTER'S EMULATION MODE. The printer is factory-set to emulate the PCL or KPD.L.

Notice

The information in this guide is subject to change without notification. Additional pages may be inserted in future editions. The user is asked to excuse any technical inaccuracies or typographical errors in the present edition.

No responsibility is assumed if accidents occur while the user is following the instructions in this guide. No responsibility is assumed for defects in the printer's firmware (contents of its read-only memory).

This guide, any copyrightable subject matter sold or provided with or in connection with the sale of the page printer, are protected by copyright. All rights are reserved. Copying or other reproduction of all or part of this guide, any copyrightable subject matter without the prior written consent of KYOCERA Document Solutions Inc. is prohibited. Any copies made of all or part of this guide, any copyrightable subject must contain the same copyright notice as the material from which the copying is done.

Regarding Trade Names

- PRESCRIBE and KPD.L are trademarks of Kyocera Corporation.
- Microsoft, Windows, Windows XP, Windows Server 2003, Windows Vista, Windows Server 2008, Windows 7 and Internet Explorer are registered trademarks or trademarks of Microsoft Corporation in the U.S.A. and/or other countries.
- PCL is a trademark of Hewlett-Packard Company.
- Adobe Acrobat, Adobe Reader and PostScript are trademarks of Adobe Systems, Incorporated.
- Ethernet is a registered trademark of Xerox Corporation.
- NetWare is a registered trademark of Novell, Inc.
- IBM is a registered trademark of International Business Machines Corporation.
- AppleTalk, Bonjour, Macintosh, and Mac OS are trademarks of Apple Inc., registered in the U.S. and other countries.
- All European language fonts installed in this machine are used under licensing agreement with Monotype Imaging Inc.
- Helvetica, Palatino and Times are registered trademarks of Linotype GmbH.
- ITC Avant Garde Gothic, ITC Bookman, ITC ZapfChancery and ITC ZapfDingbats are registered trademarks of International Typeface Corporation.
- UFST™ MicroType® fonts by Monotype Imaging Inc. are installed in this machine.

All other brands and product names are registered trademarks or trademarks of their respective companies. The designations ™ and ® will not be used in this Operation Guide.

License Agreements

GPL/LGPL

This product contains GPL (<http://www.gnu.org/licenses/gpl.html>) and/or LGPL (<http://www.gnu.org/licenses/lgpl.html>) software as part of its firmware. You can get the source code, and you are permitted to copy, redistribute and modify it under the terms of GPL/LGPL. For further information including availability of the source code, visit <http://www.kyoceradocumentsolutions.com/gpl/>.

Open SSL License

Copyright © 1998-2006 The OpenSSL Project. All rights reserved.

Redistribution and use in source and binary forms, with or without modification, are permitted provided that the following conditions are met:

- 1 Redistributions of source code must retain the above copyright notice, this list of conditions and the following disclaimer.
- 2 Redistributions in binary form must reproduce the above copyright notice, this list of conditions and the following disclaimer in the documentation and/or other materials provided with the distribution.
- 3 All advertising materials mentioning features or use of this software must display the following acknowledgment: "This product includes software developed by the OpenSSL Project for use in the OpenSSL Toolkit. (<http://www.openssl.org/>)"
- 4 The names "OpenSSL Toolkit" and "OpenSSL Project" must not be used to endorse or promote products derived from this software without prior written permission.
For written permission, please contact openssl-core@openssl.org.
- 5 Products derived from this software may not be called "OpenSSL" nor may "OpenSSL" appear in their names without prior written permission of the OpenSSL Project.
- 6 Redistributions of any form whatsoever must retain the following acknowledgment: "This product includes software developed by the OpenSSL Project for use in the OpenSSL Toolkit (<http://www.openssl.org/>)"

THIS SOFTWARE IS PROVIDED BY THE OpenSSL PROJECT "AS IS" AND ANY EXPRESSED OR IMPLIED WARRANTIES, INCLUDING, BUT NOT LIMITED TO, THE IMPLIED WARRANTIES OF MERCHANTABILITY AND FITNESS FOR A PARTICULAR PURPOSE ARE DISCLAIMED. IN NO EVENT SHALL THE OpenSSL PROJECT OR ITS CONTRIBUTORS BE LIABLE FOR ANY DIRECT, INDIRECT, INCIDENTAL, SPECIAL, EXEMPLARY, OR CONSEQUENTIAL DAMAGES (INCLUDING, BUT NOT LIMITED TO, PROCUREMENT OF SUBSTITUTE GOODS OR SERVICES; LOSS OF USE, DATA, OR PROFITS; OR BUSINESS INTERRUPTION) HOWEVER CAUSED AND ON ANY THEORY OF LIABILITY, WHETHER IN CONTRACT, STRICT LIABILITY, OR TORT (INCLUDING NEGLIGENCE OR OTHERWISE) ARISING IN ANY WAY OUT OF THE USE OF THIS SOFTWARE, EVEN IF ADVISED OF THE POSSIBILITY OF SUCH DAMAGE.

Original SSLeay License

Copyright © 1995-1998 Eric Young (ey@cryptsoft.com) All rights reserved.

This package is an SSL implementation written by Eric Young (ey@cryptsoft.com). The implementation was written so as to conform with Netscapes SSL.

This library is free for commercial and non-commercial use as long as the following conditions are adhered to. The following conditions apply to all code found in this distribution, be it the RC4, RSA, lhash, DES, etc., code; not just the SSL code. The SSL documentation included with this distribution is covered by the same copyright terms except that the holder is Tim Hudson (tjh@cryptsoft.com).

Copyright remains Eric Young's, and as such any Copyright notices in the code are not to be removed.

If this package is used in a product, Eric Young should be given attribution as the author of the parts of the library used.

This can be in the form of a textual message at program startup or in documentation (online or textual) provided with the package.

Redistribution and use in source and binary forms, with or without modification, are permitted provided that the following conditions are met:

-
- 1 Redistributions of source code must retain the copyright notice, this list of conditions and the following disclaimer.
 - 2 Redistributions in binary form must reproduce the above copyright notice, this list of conditions and the following disclaimer in the documentation and/or other materials provided with the distribution.
 - 3 All advertising materials mentioning features or use of this software must display the following acknowledgement:
"This product includes cryptographic software written by Eric Young (eay@cryptsoft.com)"
The word 'cryptographic' can be left out if the routines from the library being used are not cryptographic related :-).
 - 4 If you include any Windows specific code (or a derivative thereof) from the apps directory (application code) you must include an acknowledgement:
"This product includes software written by Tim Hudson (tjh@cryptsoft.com)"

THIS SOFTWARE IS PROVIDED BY ERIC YOUNG "AS IS" AND ANY EXPRESS OR IMPLIED WARRANTIES, INCLUDING, BUT NOT LIMITED TO, THE IMPLIED WARRANTIES OF MERCHANTABILITY AND FITNESS FOR A PARTICULAR PURPOSE ARE DISCLAIMED. IN NO EVENT SHALL THE AUTHOR OR CONTRIBUTORS BE LIABLE FOR ANY DIRECT, INDIRECT, INCIDENTAL, SPECIAL, EXEMPLARY, OR CONSEQUENTIAL DAMAGES (INCLUDING, BUT NOT LIMITED TO, PROCUREMENT OF SUBSTITUTE GOODS OR SERVICES; LOSS OF USE, DATA, OR PROFITS; OR BUSINESS INTERRUPTION) HOWEVER CAUSED AND ON ANY THEORY OF LIABILITY, WHETHER IN CONTRACT, STRICT LIABILITY, OR TORT (INCLUDING NEGLIGENCE OR OTHERWISE) ARISING IN ANY WAY OUT OF THE USE OF THIS SOFTWARE, EVEN IF ADVISED OF THE POSSIBILITY OF SUCH DAMAGE.

The licence and distribution terms for any publically available version or derivative of this code cannot be changed. i.e. this code cannot simply be copied and put under another distribution licence [including the GNU Public Licence.]

Monotype Imaging License Agreement

- 1 Software shall mean the digitally encoded, machine readable, scalable outline data as encoded in a special format as well as the UFST Software.
- 2 You agree to accept a non-exclusive license to use the Software to reproduce and display weights, styles and versions of letters, numerals, characters and symbols (Typefaces) solely for your own customary business or personal purposes at the address stated on the registration card you return to Monotype Imaging. Under the terms of this License Agreement, you have the right to use the Fonts on up to three printers. If you need to have access to the fonts on more than three printers, you need to acquire a multi-user license agreement which can be obtained from Monotype Imaging. Monotype Imaging retains all rights, title and interest to the Software and Typefaces and no rights are granted to you other than a License to use the Software on the terms expressly set forth in this Agreement.
- 3 To protect proprietary rights of Monotype Imaging, you agree to maintain the Software and other proprietary information concerning the Typefaces in strict confidence and to establish reasonable procedures regulating access to and use of the Software and Typefaces.
- 4 You agree not to duplicate or copy the Software or Typefaces, except that you may make one backup copy. You agree that any such copy shall contain the same proprietary notices as those appearing on the original.
- 5 This License shall continue until the last use of the Software and Typefaces, unless sooner terminated. This License may be terminated by Monotype Imaging if you fail to comply with the terms of this License and such failure is not remedied within thirty (30) days after notice from Monotype Imaging. When this License expires or is terminated, you shall either return to Monotype Imaging or destroy all copies of the Software and Typefaces and documentation as requested.
- 6 You agree that you will not modify, alter, disassemble, decrypt, reverse engineer or decompile the Software.
- 7 Monotype Imaging warrants that for ninety (90) days after delivery, the Software will perform in accordance with Monotype Imaging-published specifications, and the diskette will be free from defects in material and workmanship. Monotype Imaging does not warrant that the Software is free from all bugs, errors and omissions.

The parties agree that all other warranties, expressed or implied, including warranties of fitness for a particular purpose and merchantability, are excluded.

- 8 Your exclusive remedy and the sole liability of Monotype Imaging in connection with the Software and Typefaces is repair or replacement of defective parts, upon their return to Monotype Imaging.

In no event will Monotype Imaging be liable for lost profits, lost data, or any other incidental or consequential damages, or any damages caused by abuse or misapplication of the Software and Typefaces.

- 9 Massachusetts U.S.A. law governs this Agreement.
- 10 You shall not sublicense, sell, lease, or otherwise transfer the Software and/or Typefaces without the prior written consent of Monotype Imaging.
- 11 Use, duplication or disclosure by the Government is subject to restrictions as set forth in the Rights in Technical Data and Computer Software clause at FAR 252-227-7013, subdivision (b)(3)(ii) or subparagraph (c)(1)(ii), as appropriate. Further use, duplication or disclosure is subject to restrictions applicable to restricted rights software as set forth in FAR 52.227-19 (c)(2).
- 12 You acknowledge that you have read this Agreement, understand it, and agree to be bound by its terms and conditions. Neither party shall be bound by any statement or representation not contained in this Agreement. No change in this Agreement is effective unless written and signed by properly authorized representatives of each party. By opening this diskette package, you agree to accept the terms and conditions of this Agreement.

Compliance and Conformity

This equipment has been tested and found to comply with the limits for a Class B digital device, pursuant to Part 15 of the FCC Rules. These limits are designed to provide reasonable protection against harmful interference in a residential installation. This equipment generates, uses and can radiate radio frequency energy and, if not installed and used in accordance with the instructions, may cause harmful interference to radio communications. However, there is no guarantee that interference will not occur in a particular installation. If this equipment does cause harmful interference to radio or television reception, which can be determined by turning the equipment off and on, the user is encouraged to try to correct the interference by one or more of the following measures:

- Reorient or relocate the receiving antenna.
- Increase the separation between the equipment and receiver.
- Connect the equipment into an outlet on a circuit different from that to which the receiver is connected.
- Consult the dealer or an experienced radio/TV technician for help.
- The use of a non-shielded interface cable with the referenced device is prohibited.

CAUTION — The changes or modifications not expressly approved by the party responsible for compliance could void the user's authority to operate the equipment.

This device complies with Part 15 of FCC Rules.

Operation is subject to the following two conditions; (1) this device may not cause interference, and (2) this device must accept any interference, including interference that may cause undesired operation of the device.

* The above warning is valid only in the United States of America.

Interface connectors

IMPORTANT Be sure to power off the printer before connecting or disconnecting an interface cable. For protection against static electricity discharge to the printer's internal electronics through the interface connector(s), cover any interface connector that is not in use with the protective cap supplied.



Note Use shielded interface cables.

Canadian Department of Communications Compliance Statement

This Class B digital apparatus complies with Canadian ICES-003.

Avis de conformité aux normes du ministère des Communications du Canada

Cet appareil numérique de la classe B est conforme à la norme NMB-003 du Canada.

Energy Saving Control Function

To reduce energy consumption while in a waiting state, the device comes equipped with an energy saving control function for switching to a **Sleep Mode** where power consumption is automatically reduced to a minimum after a certain amount of time elapses since the device was last used. For details, refer to *Energy Saver Function on page 2-21*.

Sleep

The device automatically enters Sleep when 1 minute has passed since the device was last used. The amount of time of no activity that must pass before Sleep is activated may be lengthened. For more information, refer to *Sleep Timer (Sleep timer timeout time)* section.

There are two sleep modes: Quick Recovery and Energy Saver. The default setting is Energy Saver mode.

Quick Recovery Mode

The recovery from the sleep mode is faster than when using Energy Saver Mode. The machine automatically recovers and prints when a job is detected.

Energy Saver Mode

Makes it possible to reduce energy consumption even further than with Quick Recovery Mode.

Power Off Timer

If the printer is not used while in sleep mode, the power automatically turns off. The Power Off Timer is used to set the time until the power turns off. The factory setting for the time until the power turns off is 1 hour.

Duplex Printing

This printer includes duplex printing as a standard function. For example, by printing two single-sided originals onto a single sheet of paper as a duplex printing, it is possible to lower the amount of paper used.

Printing in duplex mode reduces paper consumption and contributes to the conservation of forest resources. Duplex mode also reduces the amount of paper that must be purchased, and thereby reduces cost. It is recommended that machines capable of duplex printing be set to use duplex mode by default.

Resource Saving - Paper

For the preservation and sustainable use of forest resources, it is recommended that recycled as well as virgin paper certified under environmental stewardship initiatives or carrying recognised ecolabels, which meet EN 12281:2002*1 or an equivalent quality standard, be used.

This machine also supports printing on 64 g/m² paper. Using such paper containing less raw materials can lead to further saving of forest resources.

*1: EN12281:2002 "Printing and business paper - Requirements for copy paper for dry toner imaging processes"

Your sales or service representative can provide information about recommended paper types.

Environmental benefits of "Power Management"

To reduce power consumption when idle, this machine is equipped with a power management function that automatically activates energy-saving mode when the machine is idle for a certain period of time. Although it takes the machine a slight amount of time to return to READY mode when in energy-saving mode, a significant reduction in energy consumption is possible.

It is recommended that the machine be used with the activation time for energy-saving mode set to the default setting.

Energy Star (ENERGY STAR®)



We have determined as a company participating in ENERGY STAR® that this product has earned the ENERGY STAR®.

ENERGY STAR® is a voluntary energy efficiency program with the goal of developing and promoting the use of products with high energy efficiency in order to help prevent global warming. By purchasing ENERGY STAR® qualified products, customers can help reduce emissions of greenhouse gases during product use and cut energy-related costs.

EN ISO 7779

Der höchste Schalldruckpegel beträgt 70 dB (A) oder weniger gemäß EN ISO 7779.

EK1-ITB 2000

Das Gerät ist nicht für die Benutzung im unmittelbaren Gesichtsfeld am Bildschirmarbeitsplatz vorgesehen. Um störende Reflexionen am Bildschirmarbeitsplatz zu vermeiden, darf dieses Produkt nicht im unmittelbaren Gesichtsfeld platziert werden.

Environment

The service environmental conditions are as follows:

- Temperature: 50 to 90.5 °F (10 to 32.5 °C)
- Humidity: 15 to 80 %

However, adverse environmental conditions may affect the image quality. Avoid the following locations when selecting a site for the machine.

- Avoid locations near a window or with exposure to direct sunlight.
- Avoid locations with vibrations.
- Avoid locations with drastic temperature fluctuations.
- Avoid locations with direct exposure to hot or cold air.
- Avoid poorly ventilated locations.

If the floor is delicate against casters, when this machine is moved after installation, the floor material may be damaged.

During printing, some ozone is released, but the amount does not cause any ill effect to one's health. If, however, the machine is used over a long period of time in a poorly ventilated room or when printing an extremely large number of copies, the smell may become unpleasant. To maintain the appropriate environment for print work, it is suggested that the room be properly ventilated.

Cautions when Handling Consumables

Do not attempt to incinerate parts which contain toner. Dangerous sparks may cause burns.

Keep parts which contain toner out of the reach of children.

If toner happens to spill from parts which contain toner, avoid inhalation and ingestion, as well as contact with your eyes and skin.

- If you do happen to inhale toner, move to a place with fresh air and gargle thoroughly with a large amount of water. If coughing develops, contact a physician.
- If you do happen to ingest toner, rinse your mouth out with water and drink 1 or 2 cups of water to dilute the contents of your stomach. If necessary, contact a physician.
- If you do happen to get toner in your eyes, flush them thoroughly with water. If there is any remaining tenderness, contact a physician.
- If toner does happen to get on your skin, wash with soap and water.

Do not attempt to force open or destroy parts which contain toner.



Other precautions

Return the exhausted toner container and waste toner box to your dealer or service representative. The collected toner container and waste toner box will be recycled or disposed in accordance with the relevant regulations.

Store the machine while avoiding exposure to direct sunlight.

Store the machine in a place where the temperature stays below 40°C while avoiding sharp changes of temperature and humidity.

If the machine will not be used for an extended period of time, remove the paper from the cassette and the Multi Purpose (MP) Tray, return it to its original package and reseal it.

SAFETY OF LASER BEAM (USA)

1. Safety of laser beam

This machine has been certified by the manufacturer to Class 1 level under the radiation performance standards established by the U.S.DHHS (Department of Health and Human Services) in 1968. This indicates that the product is safe to use during normal operation and maintenance. The laser optical system, enclosed in a protective housing and sealed within the external covers, never permits the laser beam to escape.

2. The CDRH Act

A laser-product-related act was implemented on Aug. 2, 1976, by the Center for Devices and Radiological Health (CDRH) of the U.S. Food and Drug Administration (FDA). This act prohibits the sale of laser products in the U.S. without certification, and applies to laser products manufactured after Aug. 1, 1976. The label shown below indicates compliance with the CDRH regulations and must be attached to laser products marketed in the United States. On this machine, the label is on the inside of the top cover.

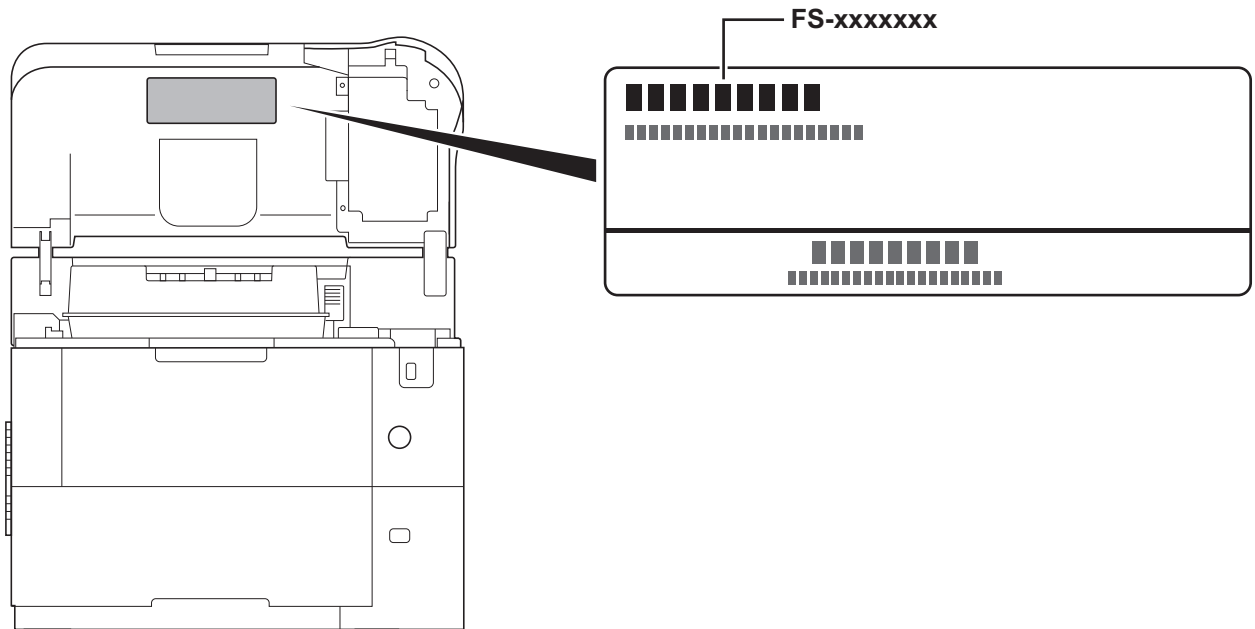

3. Optical unit

When checking the optical unit, avoid direct exposure to the laser beam, which is invisible. Shown at below is the label located on the cover of the optical unit.

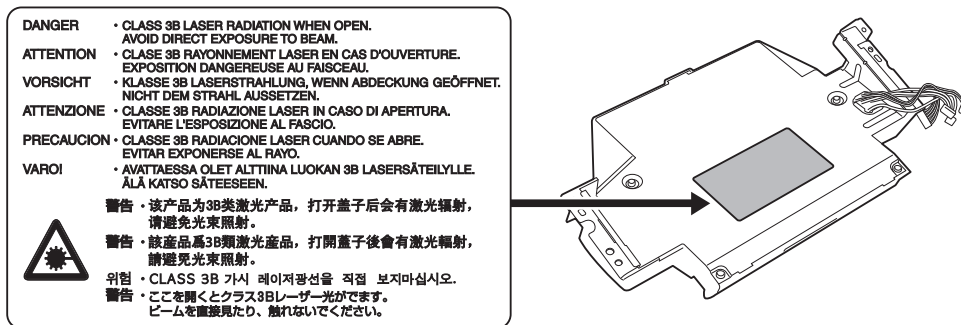

4. Maintenance

For safety of the service personnel, follow the maintenance instructions in the other section of this manual.

Safety Instructions Regarding the Disconnection of Power (USA)

Caution: The power plug is the main isolation device! Other switches on the equipment are only functional switches and are not suitable for isolating the equipment from the power source.

Attention: Le débranchement de la fiche secteur est le seul moyen de mettre l'appareil hors tension. Les interrupteurs sur l'appareil ne sont que des interrupteurs de fonctionnement: ils ne mettent pas l'appareil hors tension.

WARNING

This equipment has been tested and found to comply with the limits for a Class B digital device, pursuant to Part 15 of the FCC Rules. These limits are designed to provide reasonable protection against harmful interference in a residential installation. This equipment generates, uses and can radiate radio frequency energy and, if not installed and used in accordance with the instructions, may cause harmful interference to radio communications. However, there is no guarantee that interference will not occur in a particular installation. If this equipment does cause harmful interference to radio or television reception, which can be determined by turning the equipment off and on, the user is encouraged to try to correct the interference by one or more of the following measures:

- Reorient or relocate the receiving antenna.
- Increase the separation between the equipment and receiver.
- Connect the equipment into an outlet on a circuit different from that to which the receiver is connected.
- Consult the dealer or an experienced radio/TV technician for help.
- The use of a non-shielded interface cable with the referenced device is prohibited.

CAUTION — The changes or modifications not expressly approved by the party responsible for compliance could void the user's authority to operate the equipment.

This device complies with Part 15 of FCC Rules and RSS-Gen of IC Rules.

Operation is subject to the following two conditions; (1) this device may not cause interference, and (2) this device must accept any interference, including interference that may cause undesired operation of the device.

* The above warning is valid only in the United States of America.

Other precautions (for users in California, the United States)

Perchlorate Material - special handling may apply. See www.dtsc.ca.gov/hazardouswaste/perchlorate.

Laser Safety (Europe)

Laser radiation could be hazardous to the human body. For this reason, laser radiation emitted inside this machine is hermetically sealed within the protective housing and external cover. In the normal operation of the product by user, no radiation can leak from the machine.

This machine is classified as Class 1 laser product under IEC 60825-1:2007.

CAUTION Performance of procedures other than those specified in this manual may result in hazardous radiation exposure.

This label is attached to the laser scanner unit inside the machine and is not in a user access area.

DANGER	• CLASS 3B LASER RADIATION WHEN OPEN. AVOID DIRECT EXPOSURE TO BEAM.
ATTENTION	• CLASSE 3B RAYONNEMENT LASER EN CAS D'OUVERTURE. EXPOSITION DANGEREUSE AU FAISCEAU.
VORSICHT	• KLASSE 3B LASERSTRAHLUNG, WENN ABDECKUNG GEÖFFNET. NICHT DEM STRAHL AUSSETZEN.
ATTENZIONE	• CLASSE 3B RADIAZIONE LASER IN CASO DI APERTURA. EVITARE L'ESPOSIZIONE AL FASCIO.
PRECAUCION	• CLASSE 3B RADIACIONE LASER CUANDO SE ABRE. EVITAR EXPONERSE AL RAYO.
VAROI	• AVATTAESSA OLET ALTTIINA LUOKAN 3B LASERSÄTEILYLLÄ. ÄLÄ KATSO SÄTEESEEN.
	警告 ・该产品为3B类激光产品，打开盖子后会有激光辐射， 请避免光束照射。 警告 ・該產品為3B類激光產品，打開蓋子後會有激光輻射， 請避免光束照射。 위험 ・CLASS 3B 가시 레이저광선을 직접 보지마십시오. 警告 ・ここを開くとクラス3Bレーザー光がでます。 ビームを直接見たり、触れないでください。

About the Operation Guide

This Operation Guide has the following chapters:

Chapter 1 - Machine Parts

This chapter explains the names of parts.

Chapter 2 - Preparation before Use

This chapter explains the preparations and settings necessary before use and the method for loading paper.

Chapter 3 - Printing

This chapter explains the method for printing from a computer.

Chapter 4 - Operation Panel

This chapter explains how to use the operation panel to configure the printer.

Chapter 5 - Document Box

This chapter explains about the Document Box function.

Chapter 6 - Status Menu

This chapter explains how to check the job status and job history and how to cancel jobs being printed or waiting to print.

Chapter 7 - Maintenance

This chapter explains about the replacement of toner container and the cleaning of the printer.

Chapter 8 - Troubleshooting



This chapter explains how to handle error messages, paper jams and other problems.

Appendix

This section explains the method for entering characters, an introduction to optional products and the printer specifications.

Conventions

This manual uses the following conventions.

Convention	Description	Example
Italic Typeface	Used to emphasize a key word, phrase or reference to additional information.	To replace the toner container, refer to <i>Toner Container Replacement on page 3-2</i> .
Bold	Used to denote buttons on the software.	To start printing, click OK .
Bracket Bold	Used to denote operation panel keys.	Press [OK] to resume printing.
Note	Used to provide additional or useful information about a function or feature.	 Note Check with your network administrator for the network address settings.
Important	Used to provide important information.	IMPORTANT Ensure paper is not folded, curled, or damaged.
Caution	Indicates what must be observed to prevent injury or machine breakdown and how to deal with it.	 CAUTION The fuser unit inside the printer is hot. Do not touch it with your hands as it may result in burn injury.
Warning	Used to alert users to the possibility of <i>personal</i> injury.	 WARNING If you ship the printer, remove and pack the developer unit in a plastic bag and ship them separately from the printer.

1 Machine Parts

This chapter contains explanations on the following topics:

Components at the Front/Right of the Printer	1-2
Components at the Left of the Printer	1-2
Internal Components	1-3
Components at the Rear of the Printer	1-4
Operation Panel	1-5

Components at the Front/Right of the Printer

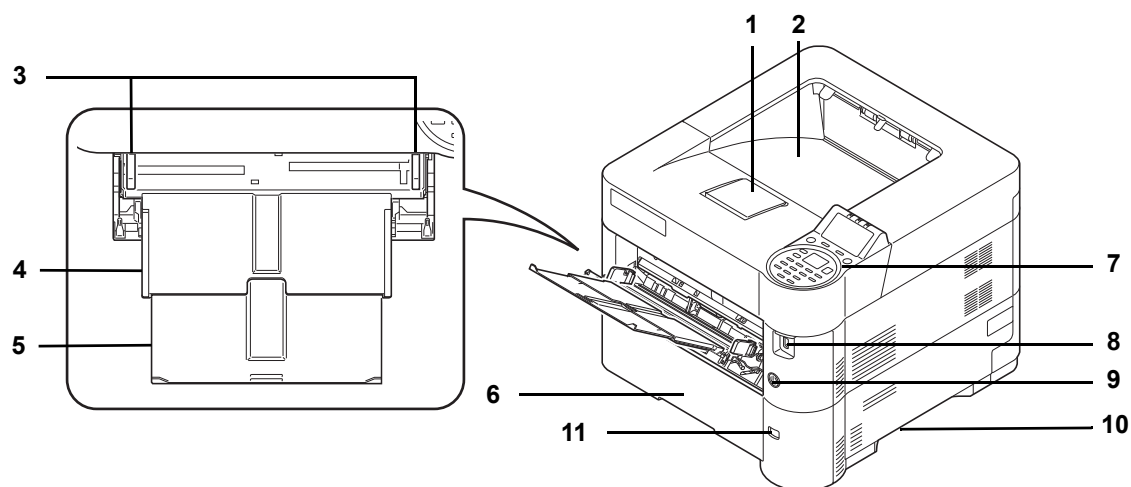

- 1 Paper Stopper
- 2 Top Tray
- 3 Paper Width Guides (MP tray)
- 4 MP (Multi-Purpose) Tray
- 5 Support Tray Section of the MP Tray
- 6 Cassette 1
- 7 Operation Panel
- 8 USB Memory Slot
- 9 Power Switch
- 10 Handholds
- 11 Paper Size Window

Components at the Left of the Printer

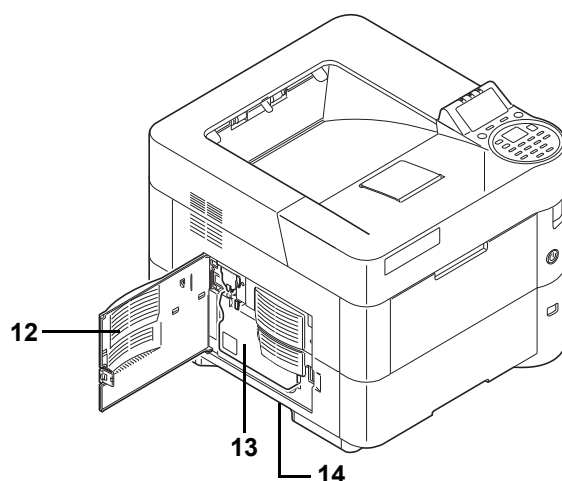

- 12 Left Cover
- 13 Waste Toner Box
- 14 Handholds

Internal Components

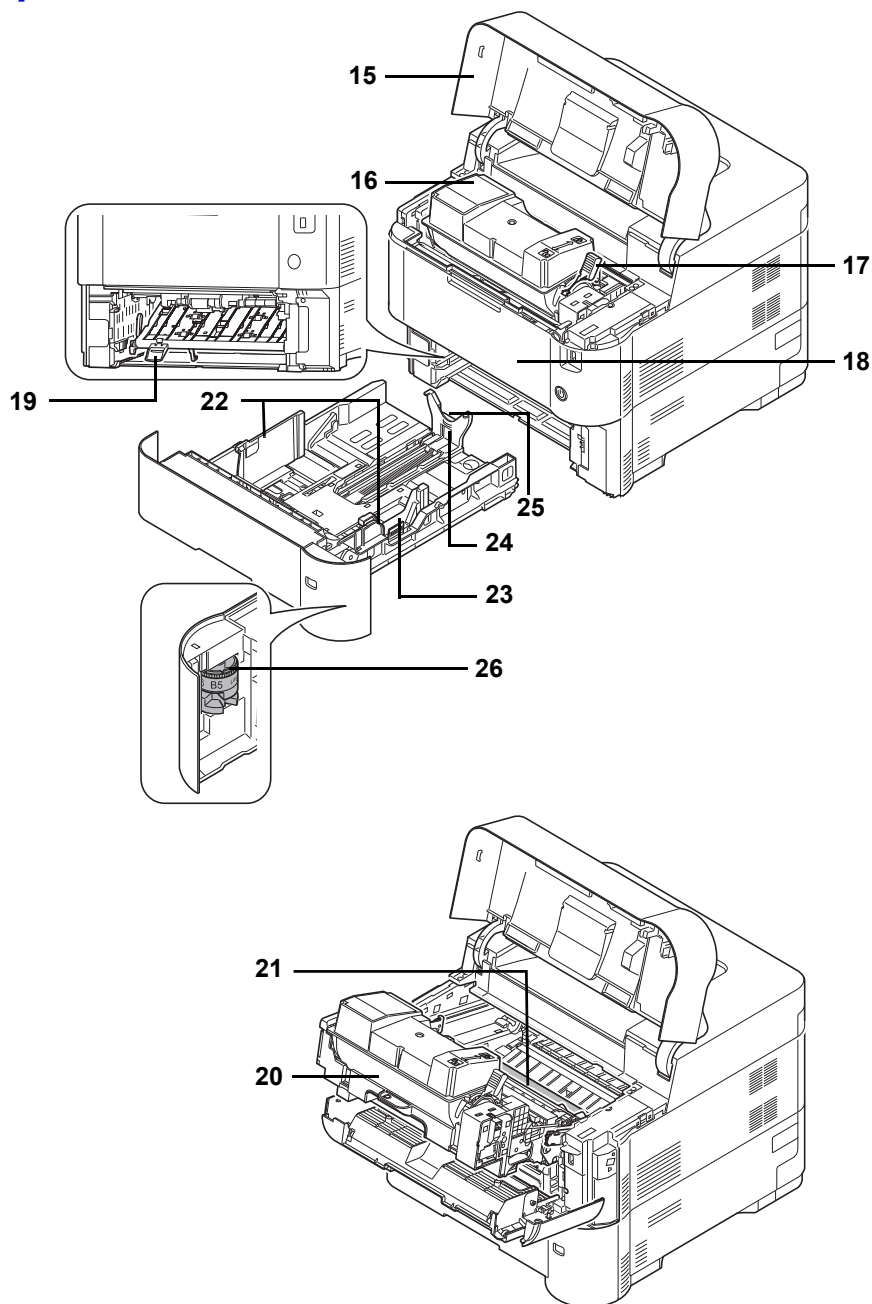

- 15** Top Cover
- 16** Toner Container
- 17** Lock Lever
- 18** Front Cover
- 19** Duplex Front Cover
- 20** Developer Unit
- 21** Registration Roller
- 22** Paper Width Guides
- 23** Paper Width Adjusting Tab
- 24** Paper Length Guide
- 25** Paper Length Adjusting Tab
- 26** Paper Size Dial

Components at the Rear of the Printer

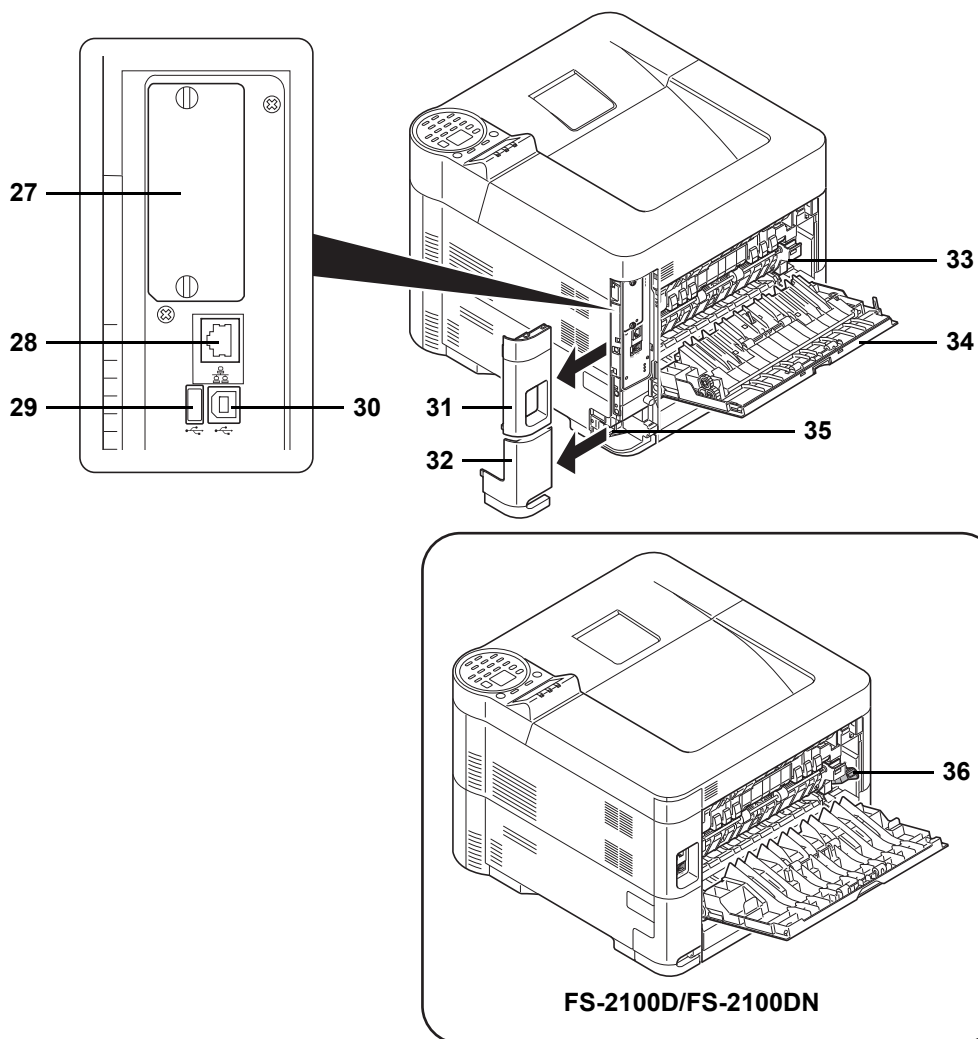

- 27** Option Interface Slot
- 28** Network Interface Connector (Only network compatible models)
- 29** USB Port (For Card Authentication Kit)
- 30** USB Interface Connector
- 31** Interface Cover
- 32** Power Cord Connector Cover
- 33** Fuser Cover
- 34** Rear Cover
- 35** Power Cord Connector
- 36** Envelope Switch (Supported on FS-2100D/FS-2100DN.)

Operation Panel

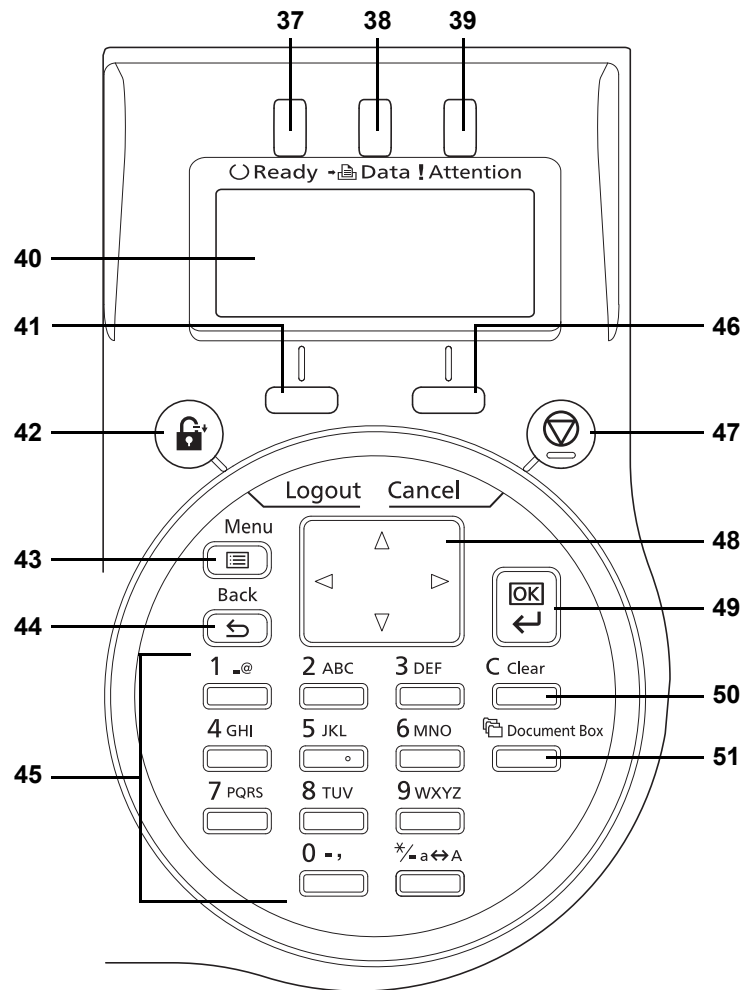

- 37 Ready Indicator
- 38 Data Indicator
- 39 Attention Indicator
- 40 Message Display
- 41 [Left Select] Key
- 42 [Logout] Key
- 43 [Menu] Key
- 44 [Back] Key
- 45 Numeric Keys
- 46 [Right Select] Key
- 47 [Cancel] Key
- 48 Arrow Keys
- 49 [OK] Key
- 50 [Clear] Key
- 51 [Document Box] Key

2 Preparation before Use

This chapter contains explanations on the following topics:

Changing Network Interface Parameters	2-2
Printing a Status Page	2-6
Installing Software	2-7
Status Monitor	2-13
Uninstalling Software (Windows PC)	2-16
Command Center RX	2-17
Power On/Off	2-20
Energy Saver Function	2-21
Loading Paper	2-22

Changing Network Interface Parameters

This printer supports TCP/IP (IPv4), TCP/IP (IPv6), IPP, SSL Server and the IPSec protocols and Security Level.

The table below shows the items required for each of the settings.

Configure the printer's network parameters as appropriate for your PC and your network environment.

Menu	Submenu		Setting	
Network	TCP/IP Settings	TCP/IP		On/Off
		IPv4 Setting	DHCP	On/Off
			Auto-IP	On/Off
			IP Address	IP address
			Subnet Mask	IP address
			Default Gateway	IP address
			Bonjour	On/Off
		IPv6 Setting	TCP/IP(IPv6)	On/Off
			RA(Sateless)	On/Off
			DHCPv6	On/Off
		Protocol Detail	NetBEUI	On/Off
			SNMPv3	On/Off
			FTP(Server)	On/Off
			SNMP	On/Off
			SMTP	On/Off
			POP3	On/Off
			RAW Port	On/Off
LPD	On/Off			
HTTP	On/Off			
LDAP	On/Off			
Restart Network			Yes/No	

Menu	Submenu		Setting		
Security	Network Security	WSD-PRINT	On/Off		
		Enhanced WSD	On/Off		
		EnhancedWSD(SSL)	On/Off		
		IPP	On/Off		
		SSL Setting	SSL	Off/On	On/Off
				Encryption	AES/DES/3DES
			IPP over SSL		On/Off
			HTTPS		On/Off
		IPSec		On/Off	
		Thin Print	Off/On	On/Off	
			Thin Print over SSL	On/Off	
		LAN Interface		Auto/10BASE-Half/ 10BASE-Full/ 100BASE-Half/ 100BASE-Full/ 1000BASE-T	

 **Note** When the network settings have been changed, restart the network card of the device. This is mandatory to make the settings effective. For details, refer to *Restart Network (Restarting the network card)* on page 4-61.

Network Settings

This section explains the settings for when DHCP is used or when an IP Address is entered while TCP(IPv4) is selected. For details of the settings, refer to *Network (Network settings)* on page 4-54. Also, for how to use the Menu Selection System, refer to *Using the Menu Selection System* on page 4-7.

 **Note** When entering an IP Address manually, check the IP Address, Subnet Mask and Default Gateway with the system administrator.

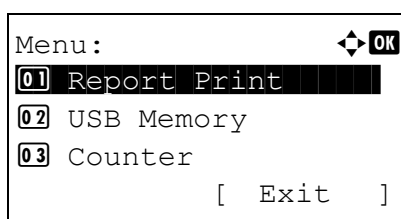

1 While the printer displays *Ready to print., Please wait. and Processing.,* press **[Menu]**. The mode selection menu is displayed.

2 Press Δ or ∇ to select *Network*.

3 Press **[OK]**. The *Network* menu screen appears.

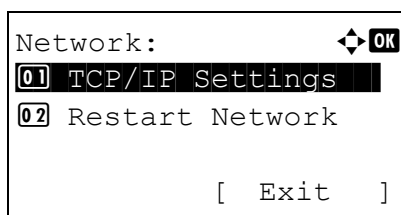

Checking that TCP/IP is On

This is an explanation of the method for setting for IPv4, but TCP/IP should also be On when setting for IPv6.

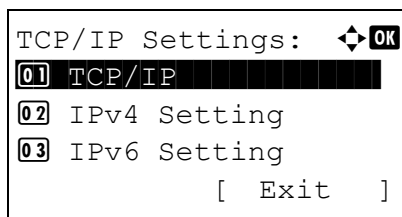

- 4** Select **TCP/IP Settings** and press **[OK]**. The **TCP/IP Settings** menu screen appears.

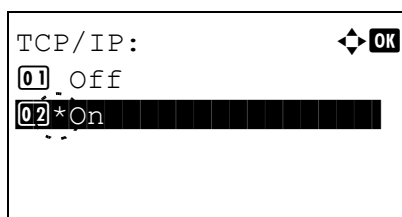

- 5** Press Δ or ∇ to select **TCP/IP**.

- 6** Press **[OK]**. The **TCP/IP** screen appears.

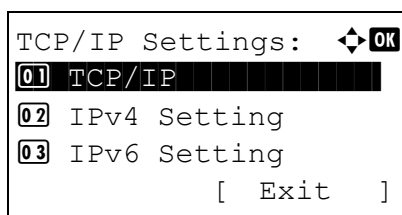

- 7** Check that **On** is selected. If **Off** is selected, then press Δ or ∇ to select **On**.



Note "*" is displayed for the setting which has been selected.

- 8** Press **[OK]**. The **TCP/IP** setting is set and the **TCP/IP Settings** menu reappears.

Switching DHCP to Off or On

Select **On** when using a DHCP server to automatically obtain an IP Address. Select **Off** to enter an IP Address.

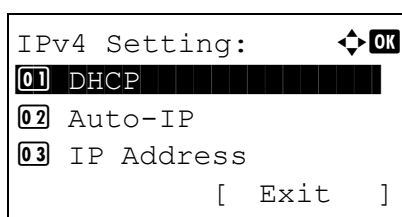

- 9** Press Δ or ∇ to select **IPv4 Setting**.

- 10** Press **[OK]**. The **IPv4 Setting** menu screen appears.

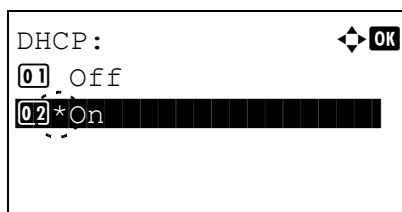

- 11** Press Δ or ∇ to select **DHCP**.

- 12** Press **[OK]**. The **DHCP** screen appears.

- 13** Press Δ or ∇ to select **Off** or **On**.

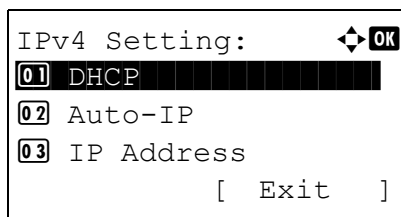

- 14** Press **[OK]**. The DHCP setting is set and the IPv4 Setting menu reappears.



Note DHCP becomes effective when *On* is selected. Press **[Menu]** to end the mode selection menu.

When *Off* is set, continue on to enter the IP Address.

Entering the IP address

If DHCP is set to *off*, enter the IP Address manually.

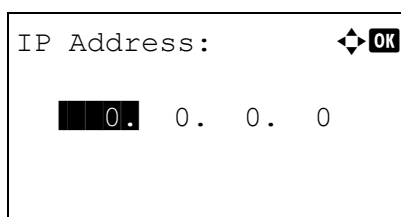

- 15** Press Δ or ∇ to select IP Address.
- 16** Press **[OK]**. The IP Address screen appears.

- 17** Use the numeric keys or Δ or ∇ to set the IP address.

You can set any value between 000 and 255.

Increase or reduce the figures by pressing Δ or ∇ .

Use \triangleleft and \triangleright to move the position being entered, which is shown highlighted.

- 18** Press **[OK]**. The IP address is stored and the IPv4 Setting menu reappears.

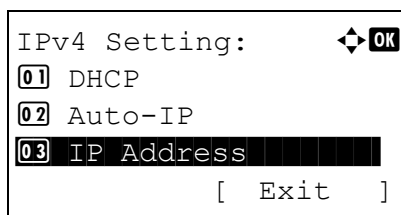

Entering the Subnet Mask

When DHCP is set to *off*, enter the Subnet Mask manually.

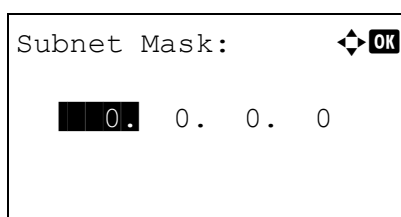

- 19** Press Δ or ∇ to select Subnet Mask.
- 20** Press **[OK]**. The Subnet Mask screen appears.

- 21** Use the numeric keys or Δ or ∇ to set the subnet mask.

You can set any value between 000 and 255.

The method for entering is the same as for the IP Address.

- 22** Press **[OK]**. The subnet mask setting is stored and the IPv4 Setting menu reappears.

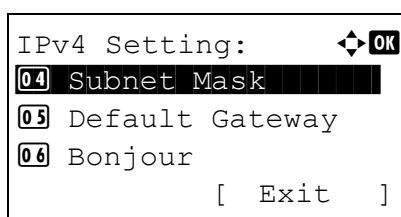

Entering the Default Gateway

When DHCP is set to `Off`, enter the Default Gateway manually.

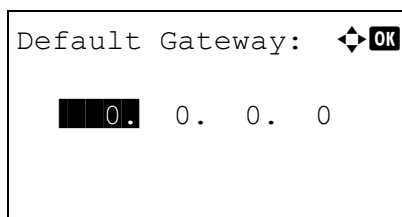

- 23** Press Δ or ∇ to select `Default Gateway`.
- 24** Press **[OK]**. The `Default Gateway` screen appears.

- 25** Use the numeric keys or press Δ or ∇ to set the default gateway.
You can set any value between `000` and `255`.
The method for entering is the same as for the IP Address.

- 26** Press **[OK]**. The default gateway is stored and the `IPv4 Setting` menu reappears.

This completes the network settings. Press **[Menu]** and end the mode selection menu.



Note When the network settings have been changed, restart the network card of the device. This is mandatory to make the settings effective. For details, refer to *Restart Network (Restarting the network card)* on page 4-61.

Printing a Status Page

After completing the network settings, print a status page. The status page allows you to confirm a range of information, including network addresses and network protocols.

To print a status page, select `Status Page` from the `Report Print` menu. Refer to *Report Print on page 4-10* for detailed information.

Installing Software

Ensure the printer is plugged in and connected to the PC before installing the printer driver and utilities from the *Product Library* disc.

Software

The following software can be installed from the provided *Product Library* disc.

In Express Mode, the KX Driver and Fonts are installed automatically. In Custom Mode, select and install the software.

●: Installed as standard. ○: Installed if selected.

Software	Function	Description	Installation Method	
			Express Mode	Custom Mode
KX DRIVER	Print	Driver for printing files on a computer with the machine. This printer driver enables full use of the machine's features.	●	○
KX XPS DRIVER		Printer driver for the XPS (XML Paper Specification) format developed by Microsoft Corporation. Use the XPS driver to print from applications that support XPS. (Windows 7, Windows Vista, Windows Server 2008/R2 only.)	—	○
PCL mini-driver		A Microsoft Mini Driver type driver which emulates and outputs both PCL and KPD. KPD is Kyocera's implementation of the PostScript language. With this driver, it is only possible to use a limited number of all the functions of the machine and the optional functions there are.	—	○
KPDL mini-driver			—	○
KYOCERA Net Viewer	Utility	Utility that enables the machine, when connected to a network, to be monitored.	—	○
KYOCERA Net Direct Print		Simple printing of PDF documents.	—	○
Fonts		These are the screen fonts equivalent to the printer fonts.	●	○

Installing the Software in Windows

If you are connecting this printer to a Windows PC, follow the next steps to install the printer driver. The example shows you how to connect your printer to a Windows 7.



Note In Windows operating systems, you must be logged on with administrator rights to install the printer driver.

You can use either Express Mode or Custom Mode to install the software. Express Mode automatically detects connected printers and installs the required software. Use Custom Mode if you want to specify the printer port and select the software to be installed.

- 1 Turn on the computer and start up Windows.
If the Welcome to the Found New Hardware Wizard dialog box displays, select **Cancel**.
- 2 Insert the *Product Library* disc supplied with the printer into the optical drive of the PC. In Windows 7, Windows Server 2008/R2 and

Windows Vista, the user account management window appears. Click **Yes**.

The installation program launches.



Note If the Product Library does not launch automatically, open the *Product Library* disc window in Windows Explorer and double-click **Setup.exe**.

- 3 Click **View License Agreement** and read the License Agreement. Click **Accept**.

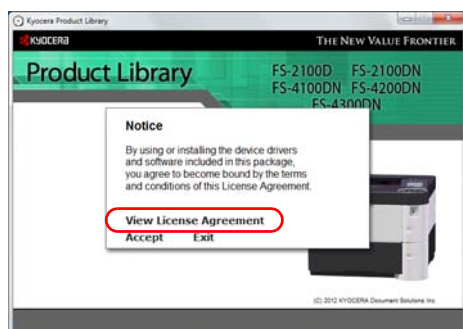

- 4 Click **Install software**.

The software install wizard starts up.

From this point, the procedure differs depending on your version of Windows and your connection method. Proceed to the correct procedure for your connection type.

- Express Mode
- Custom Mode

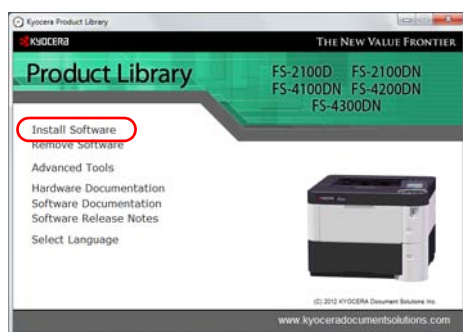

Express Mode

In Express Mode, the installer automatically detects the printer when it is turned on. Use Express Mode for standard connection methods.

- 1 In the installation method selection window, select **Express Mode**. The print system detection window appears and the installer detects the connected printers. If the installer does not detect a print system, check that the print system is connected via USB or a network and that it is turned on. Then return to the print system detection window.



Note While the information shown in Windows 7 and Windows Vista/Windows XP installation dialog boxes differs slightly, the installation procedure is the same.

Network connection is only on network compatible models.



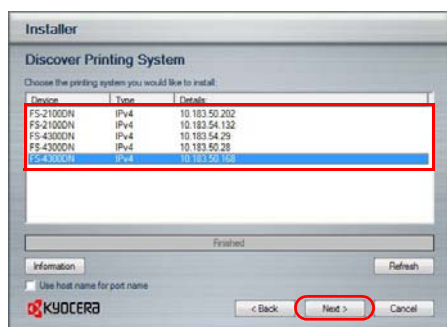

- 2 Select the print system to be installed and click **Next**.



Note If the Found New Hardware Wizard appears, click **Cancel**. If a hardware installation warning message appears, click **Continue**.



- 3 You can customize the print system name in the installation settings window. This will be the name displayed in the Printer window and in the printer lists displayed in applications. Specify whether to share the print system name or set the print system as an existing printer and then click **Next**.

IMPORTANT Step 3 only appears if the print system is connected via a network. It does not appear if the print system is connected via a USB.

Network connection is only on network compatible models.

- 4 A window appears in which you can check the settings. Check the settings carefully and then click **Install**.



Note If the Windows security window appears, click **Install this driver software anyway**.

- 5 A message appears saying that the printer has been installed successfully. Click **Finish** to exit the printer installation wizard and return the *Product Library* disc main menu.

If the device setup dialog box appears after you click **Finish**, you can specify the settings for items such as optional features installed in the print system. You can also specify the device settings after you exit the installation. For details, refer to the *Printer Driver User Guide* on the *Product Library* disc.

This completes the printer driver installation procedure. Follow the on-screen instructions to restart the system, if required.

Custom Mode

Use Custom Mode if you want to specify the printer port and select the software to be installed.

For example, if you do not want fonts installed on your computer to be replaced, select **Custom Mode** and deselect the **Fonts** checkbox in the utility tab.

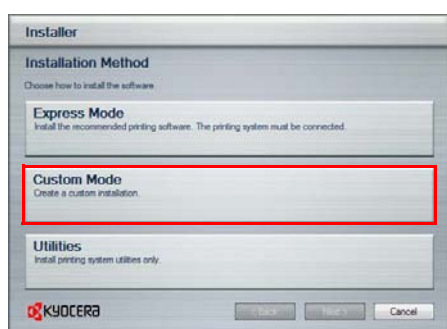

- 1 Select **Custom Mode**.
- 2 Following the instructions in the install wizard window, select the software packages to be installed and specify the port, etc.
For details, refer to the *Printer Driver User Guide* on the *Product Library* disc.

Installation on a Macintosh

- 1 Turn on the printer and the Macintosh.
- 2 Insert the *Product Library* disc supplied with the printer into the optical drive of the Macintosh.
- 3 Double click the *Product Library* disc icon displayed on the desktop.
- 4 Double-click either **OS X 10.4 Only** or **OS X 10.5 or higher** depending on your Mac OS version.

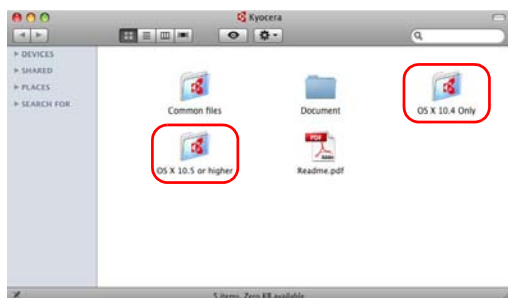

- 5 Double-click **Kyocera OS X 10.x**.

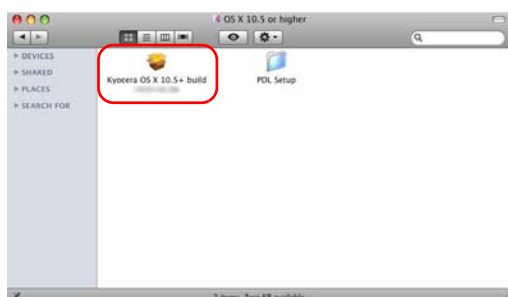

- 6 The printer driver installation program starts up.
- 7 Choose **Destination Select**, **Installation Type** and then install the printer driver as directed by the instructions in the installation software.



Note In addition to **Standard Install**, the **Installation Type** options include **Custom Install**, which allows you to specify the components to be installed.

IMPORTANT In the Authentication screen, enter the name and password used to log in to the operating system.

This completes the printer driver installation. Next, specify the print settings.

If an IP or AppleTalk connection is used, the settings below are required. If a USB connection is used, the printer is automatically recognized and connected.

- 8 Open **System Preferences** and click **Print & Fax**.



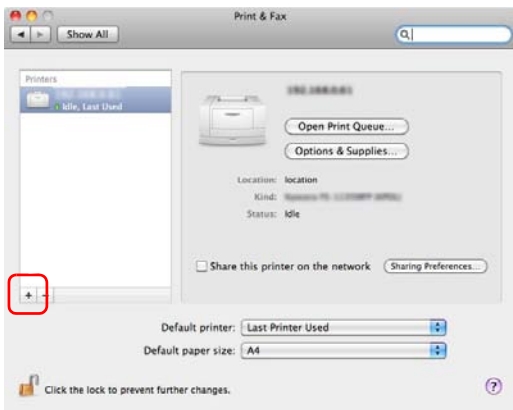

9 Click the plus symbol (+) to add the installed printer driver.

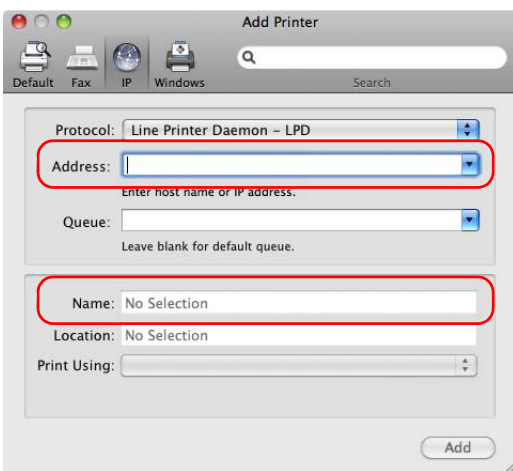

10 Click the IP icon for an IP connection and then enter the IP address and printer name.

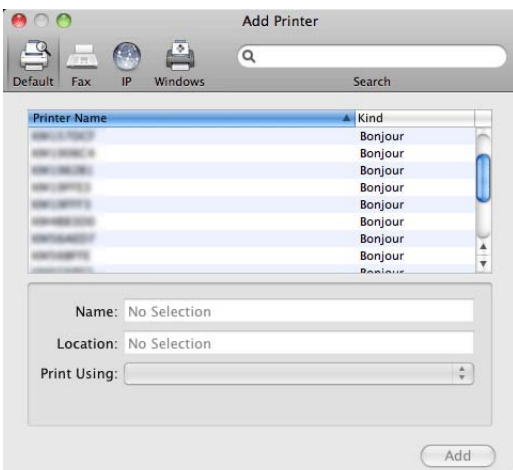

For a Bonjour connection, click the default icon and select the printer for which Bonjour appears in Connection.

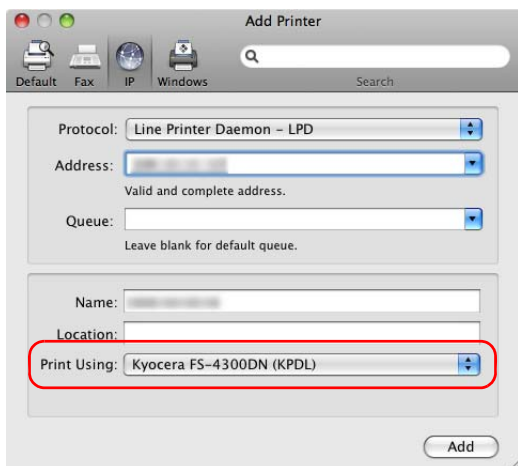

11 Select the installed printer driver and click **Add**.

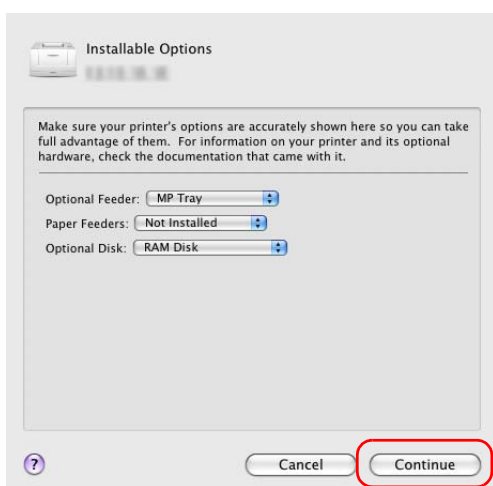

12 Select the options available for the printer and click **Continue**.



13 The selected printer is added. This completes the printer setup procedure.

Status Monitor

The Status Monitor monitors the printer status and provides an ongoing reporting function. It also allows you to specify and modify settings for printers not included in the KX driver.

The Status Monitor is installed automatically during KX driver installation.

Accessing the Status Monitor

Use either of the methods listed below to launch the Status Monitor.

- Launch when printing starts:
When you specify a printer and start a print job, one Status Monitor is launched for each printer name. If Status Monitor startup is requested from multiple printers, Status Monitors are launched for each printer that issues the request.
- Launch from the KX driver properties:
Click the **Status Monitor** button in the Advanced tab. Then click **Open Status Monitor** button in the Status Monitor dialog box to launch the Status Monitor.

Exiting the Status Monitor

Use either of the methods listed below to exit the Status Monitor.

- Exit manually:
Right-click the Status Monitor icon in the taskbar and select **Exit** in the menu to exit the Status Monitor.
- Exit automatically:
The Status Monitor automatically shuts down after 5 minutes if it is not being used.

Screen Overview

The screen overview of the Status Monitor is as follows.

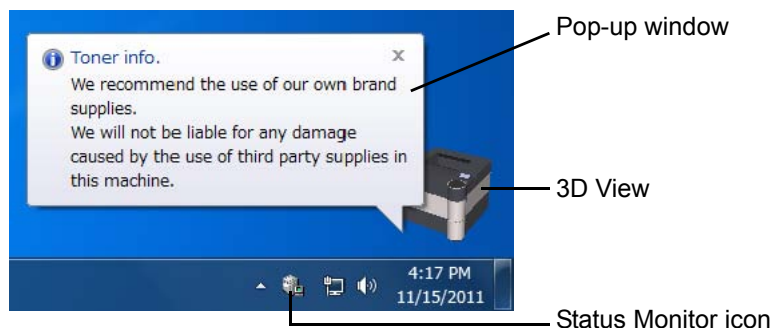

Pop-up window

If an information notification event occurs, a pop-up window appears. This window only appears when the 3D View is open on the desktop.

3D View

This shows the status of the monitored printer as a 3D image. You can choose whether to show or hide the 3D view from the menu displayed when you right-click the Status Monitor icon.

If an information notification event occurs, the 3D view and an alert sound are used to notify you. For information on the sound notification settings, refer to *Notification Settings on page 2-15*.

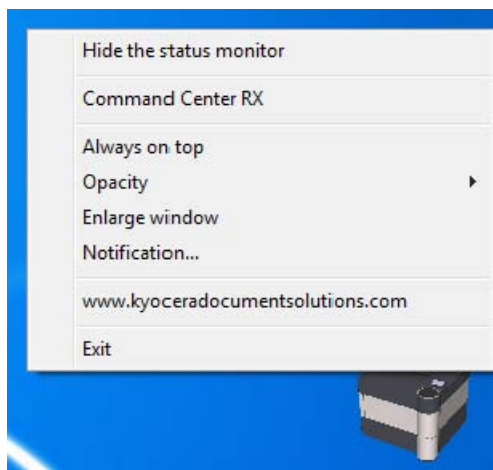

Status Monitor icon

While the **Status Monitor** is running, its icon is displayed in the taskbar notification area. When you position the cursor over the icon, the printer name appears. Right-clicking the **Status Monitor icon** allows you to set the options below.

Show/Hide the status monitor

Displays or hides the **Status Monitor icon**.

Command Center RX

If the printer is connected to a TCP/IP network and has its own IP address, use a web browser to access the Command Center RX to modify or confirm the network settings. For more information, refer to the *Command Center RX User Guide*.

Always on top

Positions the Status Monitor in front of other active windows.

Opacity

Adjusts the Status Monitor to let a variable amount of background to show through the image. Select a percentage between 20 to 100.

Enlarge window

Doubles the size of the Status Monitor window.

Notification...

Specify the **Notification** setting for the Status Monitor. For details, refer to *Notification Settings on page 2-15*.

www.kyoceradocumentsolutions.com

Accesses the KYOCERA Document Solutions global website.

Exit

Exits the **Status Monitor**.

Notification Settings

Use the **Notification** option to set up the Status Monitor.

The **Notification** tab contains the following items.

IMPORTANT To confirm the settings on the Notification tab, the computer requires the sound capabilities such as a sound card and speaker.

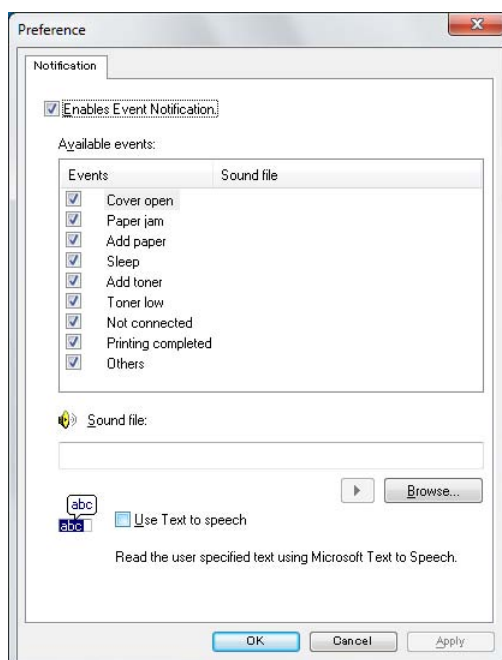

Enables Event Notification

Select to enable or disable monitoring the events in Available events.

Sound file

A sound file can be selected if you require an audible notification. Click **Browse** to search for the sound file.

Use Text to speech

Select this check box to enter text you would like to hear played for events. Although a sound file is unnecessary, this function is applicable for Windows XP or later.

To use this function, follow these steps.

- 1** Select **Enables Event Notification**.
- 2** Select an event to use with the text to speech and playing sound file function in Available events.
- 3** Click Browse to notify the event by sound file.



Note The available file format is WAV.

Select **Use Text to speech** to hear the text entered in the Text to speech box when an event occurs.

- 4** Click **Play** to confirm the sound or text is played correctly.

Uninstalling Software (Windows PC)

The software can be uninstalled (removed) using the *Product Library* disc supplied with the printer.

IMPORTANT On Macintosh computers, because the printer settings are specified using a PPD (PostScript Printer Description) file, the software cannot be uninstalled using the *Product Library* disc.

- 1** Exit all active software applications.
- 2** Insert the *Product Library* disc supplied with the printer into the optical drive.
- 3** Following the procedure used to install the printer driver, click **Remove Software**. The Software Remove wizard appears.
- 4** Select the software package to remove.
- 5** Click **Uninstall**.



Note In Windows Vista, the **Remove Driver and Package** screen appears. Select **Remove driver and driver package**, and click **OK**. When KYOCERA Net Viewer or KYOCERA Net Direct Print is installed, separate uninstallers are launched for each application. Proceed with the uninstallation steps for each application as directed by the on-screen instructions.

The uninstaller starts.

- 6** When the Uninstall complete screen appears, click **Next**.
- 7** Select whether you restart your computer or not, click **Finish**.

Command Center RX

Command Center RX is a tool used for tasks such as verifying the operating status of the machine on the web and changing the settings for security, network printing and advanced networking.

If the E-mail settings are made then it is possible to send notification by E-mail when a job is completed.

 **Note** To change settings in Command Center RX, you must log in as an administrator of the machine. The default factory settings are set as shown below.

Login User Name: Admin

Login Password: Admin

The operation procedure for accessing Command Center RX is as follows.

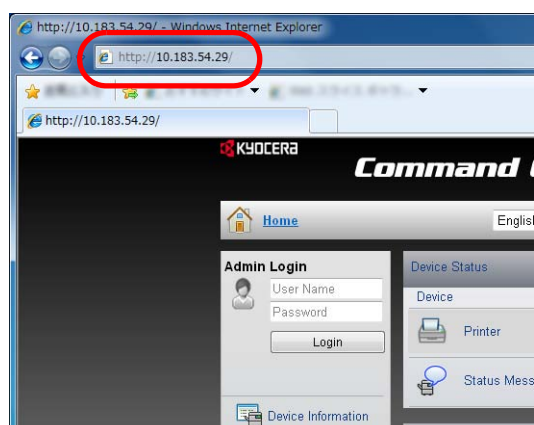

- 1 Start the web browser.
- 2 In the Address or Location bar, enter the machine's IP address.
e.g.) http://10.183.54.29/

The web page displays basic information about the machine and Command Center RX as well as their current status.

- 3 Select an item from the navigation bar on the left of the screen. The settings must be configured separately depending on the items.
If restrictions have been set for Command Center RX, enter the correct user name and password to access pages other than the startup page.

For more information, refer to the *Command Center RX User Guide*.

E-mail Setting

Specifying the SMTP settings allows you to send notification of the end of a Job via E-mail.

To use this function, this machine must be connected to a mail server using the SMTP protocol.

Also, check the following:

- The network environment used to connect this machine to the mail server
A full-time connection via a LAN is recommended.
- SMTP Settings
Use Command Center RX to register the IP address or host name of the SMTP server.
- If limits have been set on the size of E-mail messages, it may not be possible to send large volume E-mails.

The procedure for specifying the SMTP settings is explained below.

- 1 Click **Settings** -> **Advanced** -> **SMTP** -> **General**.

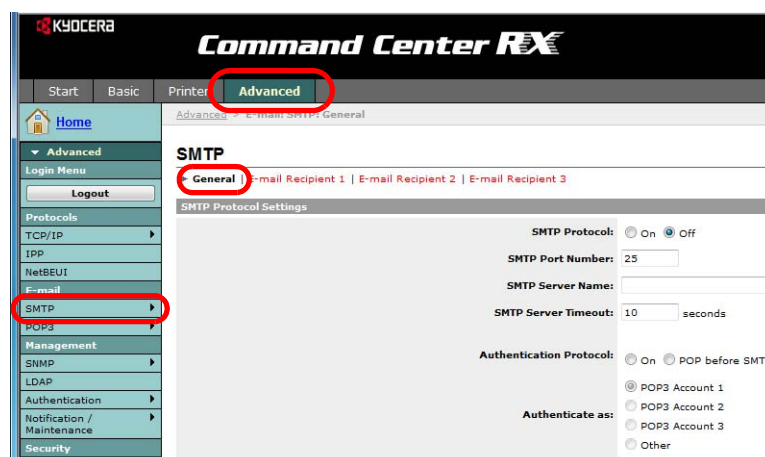

2 Enter the correct settings in each field.

The settings to be specified in the SMTP settings screen are shown below.

Item	Description
SMTP Protocol	Enables or disables SMTP protocol. To use E-mail, this protocol must be enabled.
SMTP Port Number	Set the SMTP Port Number. Normally use the port No. 25.
SMTP Server Name	Enter the SMTP server IP address or its name. The maximum length of the SMTP server name and IP address is 64 characters. If entering the server name, an IP address of DNS server must also be configured. The DNS server address can be entered on the TCP/IP setting screen.
SMTP Server Timeout	Set the amount of time, in seconds, to wait before time-out.
Authentication Protocol	Enables or disables the SMTP authentication protocol or sets POP before SMTP as the protocol. The SMTP authentication supports Microsoft Exchange 2000.
Authenticate as	Authentication can be set from three POP3 accounts or you can choose a different account.
Login User Name	When Other is selected for Authentication, the login user name entered here will be used for SMTP authentication. The maximum length of the login user name is 64 characters.
Login Password	When Other is selected for Authentication, the password entered here will be used for authentication. The maximum length of the login password is 64 characters.
SMTP Security	Enables or disables the SMTP Security. When this protocol is enabled, either SSL/TLS or STARTTLS must be selected. To enable SMTP security, the SMTP port number may have to be changed according to the server settings. Typically, 465 for SSL/TLS and 25 or 587 for STARTTLS are used for SMTP ports.
POP before SMTP Timeout	Set the amount of time to wait, in seconds, before time-out when you have selected POP before SMTP as the Authentication Protocol.
Test	This will test if the SMTP connection can be successfully established.
E-mail Size Limit	Enter the maximum size of E-mail that can be sent in kilobytes. When the value is 0, the limitation for E-mail size is disabled.
Sender Address	Enter the E-mail address of the person responsible for the machine, such as the machine administrator, so that a reply or non-delivery report will go to a person rather than to the machine. The sender address must be entered correctly for SMTP authentication. The maximum length of the sender address is 128 characters.
Signature	Enter the signature. The signature is free form text that will appear at the end of the E-mail body. It is occasionally used for further identification of the print system. The maximum length of the signature is 512 characters.
Domain Restriction	Enter the domain names that can be permitted or rejected. The maximum length of the domain name is 32 characters.

Dynamic Domain Name System (DDNS)

This printer supports DDNS through DHCP. To use this system, you have to set the **DHCP/BOOTP** option to **On** first.

Set the **DDNS** to **On** to use the DDNS service to update the correspondence of the host names and IP addresses.

Refer to the *Command Center RX User Guide* for the method for setting this.

Lock Operation Panel

Restricts the operation from the Operation Panel. In order to operate locked menus, it is necessary to be logged in as a user with Administrator authority.

The setting of Lock Operation Panel is done from Command Center RX. For the method for the setting, refer to the *Command Center RX User Guide*.

The operations restricted by Lock Operation Panel are as follows.

Operation	Lock Operation Panel settings				
	Unlock	Partial Lock1	Partial Lock2	Partial Lock3	Lock
System Menu					
Report Print	—	—	—	●	●
USB Memory	—	—	—	●	●
Counter	—	—	—	●	●
Paper Settings	—	—	—	●	●
Print Settings	—	—	●	●	●
Network	—	●	●	●	●
Optional Network* ¹	●	●	●	●	●
Device Common	—	●	●	●	●
Security* ¹	●	●	●	●	●
User/Job Account* ¹	●	●	●	●	●
Adjust/Maint.	—	●	●	●	●
Op Functions* ¹	●	●	●	●	●
Document Box					
Custom Box	—	●* ²	●* ²	●	●
Job Box	—	—	●* ³	●	●
Operation Panel key operation	—	—	—	○* ⁴	○* ⁵

●: It is necessary to log in as a user with Administrator authority to operate this.

—: No restrictions.

*1: Regardless of the Lock Operation Panel setting, it is necessary to be logged in as a user with Administrator authority.

●*2: The addition and editing of Custom Box are restricted.

●*3: Job Box Setting is restricted.

○*4: Only **[Logout]** and operation for canceling printing are effective.

○*5: Only **[Logout]** and **[Cancel]** for stopping the buzzer are effective.

 **Note** Optional Network is only displayed when a network interface kit (IB-50) or wireless network interface kit (IB-51) is installed as an option.

Power On/Off

Power On

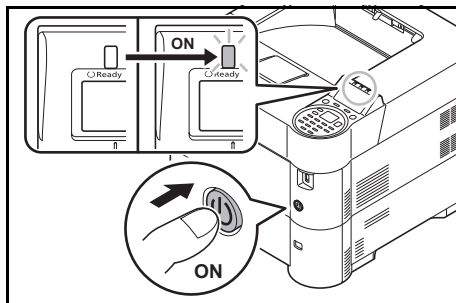

- 1 Press the Power switch.

IMPORTANT When turning off the power switch, do not turn on the power switch again immediately. Wait more than 5 seconds, and then turn on the power switch.

Power Off

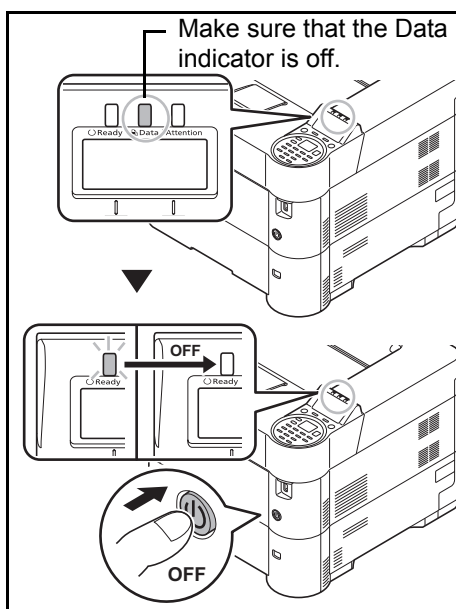

- 1 Make sure that the Data indicator is off, then press the Power switch.

Energy Saver Function

Sleep

When the set time (factory setting is 1 minute) elapses after the printer is last used, the printer automatically enters sleep mode. The message display backlight and lights turn off to minimize power consumption. This status is referred to as Sleep.

There are two sleep modes: Quick Recovery and Energy Saver. The default setting is Energy Saver mode.

Quick Recovery Mode

The recovery from the sleep mode is faster than when using Energy Saver mode.

The message display goes off when sleep mode is entered and the **Ready** indicator flashes.

The machine recovers quickly when **[OK]** is pressed. The machine also automatically recovers and prints when a job is detected.

If print data is received during Sleep, the print job is performed while the message display remains unlit.

To use the printer, press **[OK]**. The printer will be ready to use within 15 seconds (FS-2100D/FS-2100DN/FS-4100DN), 20 seconds (FS-4200DN), or 25 seconds (FS-4300DN).

Note that ambient environmental conditions, such as ventilation, may cause the machine to respond more slowly.

For more information about configuring settings, refer to *Sleep Timer (Sleep timer timeout time)* on page 4-90.

Energy Saver Mode

This mode reduces power consumption even more than quick recovery mode, and allows Sleep mode to be set separately for each function.

IMPORTANT Cautions when setting the Energy Saver mode

- The data stored on the RAM disk is deleted when the machine goes into Energy Saver mode.
- The machine will not recover from sleep mode if printing data is received from a computer via a USB cable. (FS-2100D will recover.)
- An ID card is not recognized when in Energy Saver mode.

To use the printer, press **[OK]**. The time required for the printer to wake up from sleep mode and resume normal operation will be longer than for quick recovery mode.

For more information on Energy Saver settings, refer to *Sleep Level Set. (Sleep level setting)* on page 4-88.

Power Off Timer

If the printer is not used while in sleep mode, the power automatically turns off. The Power Off Timer is used to set the time until the power turns off. The factory setting for the time until the power turns off is 1 hour.

IMPORTANT You can set the power off rule and power off timer. For details, refer to *Power Off Rule (Power Off Rule setting)* on page 4-90 and *Power Off Timer (Power off timer settings)* on page 4-91.

In case of not using the printer for an extended period of time



CAUTION If this printer will be left unused for an extended period (e.g. overnight), turn it off at the power switch. If the printer will not be used for an even longer period of time (e.g. vacation), remove the power plug from the outlet as a safety precaution.

CAUTION Remove paper from the cassettes and seal it in the paper storage bag to protect it from humidity.

Loading Paper

The following explains the procedure for loading paper in the cassette and the MP tray.

Loading Paper into the Cassette

The standard cassette holds up to 500 sheets of A4 or smaller plain paper (80 g/m²).

The following paper sizes are supported: 8-1/2 × 14" (Legal), Oficio II, 8-1/2 × 11" (Letter), Executive, Statement, A4, B5, A5, A6, B6, Folio, 216 × 340 mm, 16K, ISO B5, Envelope DL, Oufuku Hagaki, Envelope C5 and Custom.

IMPORTANT You should not use inkjet printer paper or any paper with a special surface coating. (Such papers may cause paper jams or other faults.)

When using media types other than plain paper (such as recycled or colored paper), always specify the media type setting. (Refer to *Cassette (1 to 5) Set. (Settings for the cassettes) on page 4-28.*) The cassettes can hold paper with weights up to 120 g/m².

Do not load thick paper that is heavier than 120 g/m² in the cassettes. Use the multi purpose tray for paper that is heavier than 120 g/m².

 **Note** A6 can only be used in cassette 1.

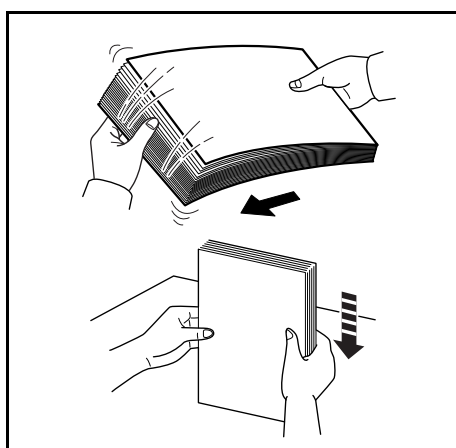

- 1** Fan the media (paper/transparencies), then tap it on a level surface to avoid media jams or skewed printing.

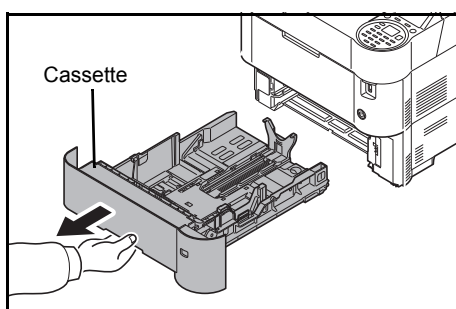

- 2** Pull the cassette completely out of the machine.

IMPORTANT When pulling the cassette out of the machine, ensure it is supported and does not fall out.

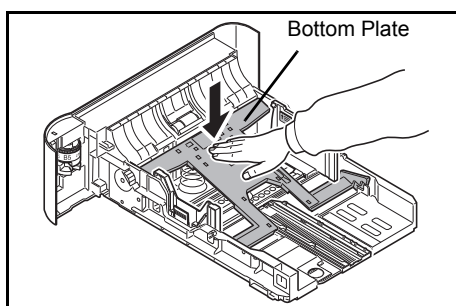

- 3** (On FS-2100D/FS-2100DN only) Press the bottom plate down until it locks.

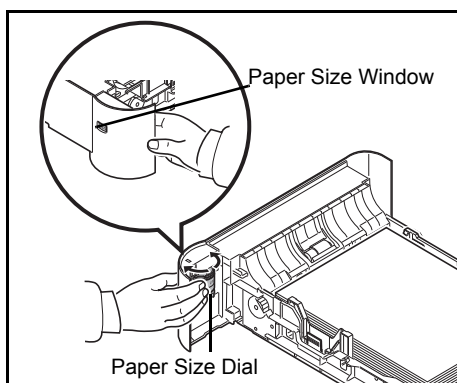

- 4 Turn the Paper Size Dial so that the size of the paper you are going to use appears in the Paper Size Window.



Note When the Paper Size Dial is set to **Other** the paper size must be set into the printer on the operation panel. Refer to *Cassette (1 to 5) Set. (Settings for the cassettes)* on page 4-28.

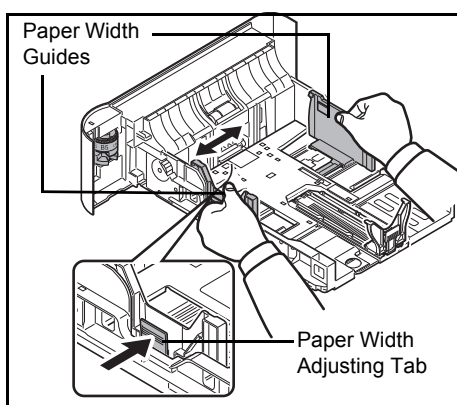

- 5 Adjust the position of the paper width guides located on the left and right sides of the cassette. Press the paper width adjusting tab and slide the guides to the paper size required.

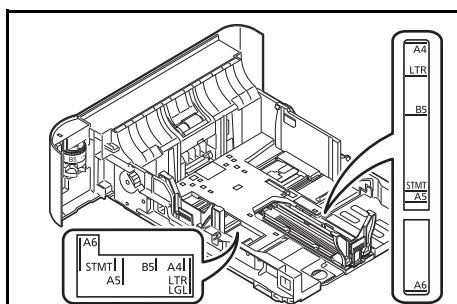

Note Paper sizes are marked on the cassette.

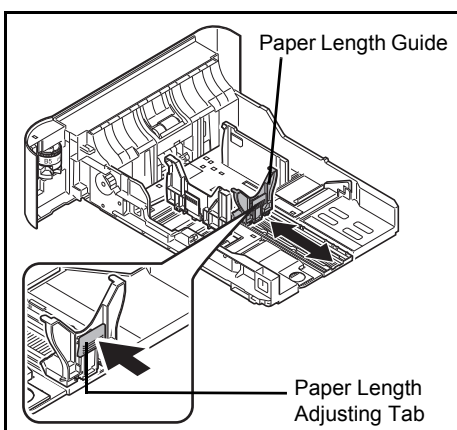

- 6 Adjust the paper length guide to the paper size required.

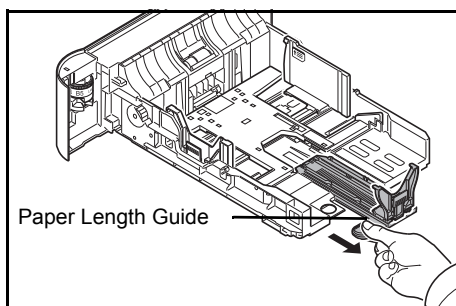

If you are going to use paper that is longer than A4, pull out the paper length guide backwards.

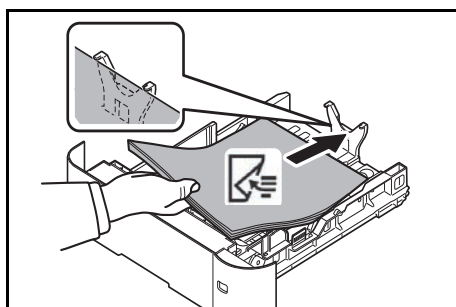

- 7** Load the paper in the cassette. Ensure the side to be printed is facing down and the paper is not folded, curled, or damaged.

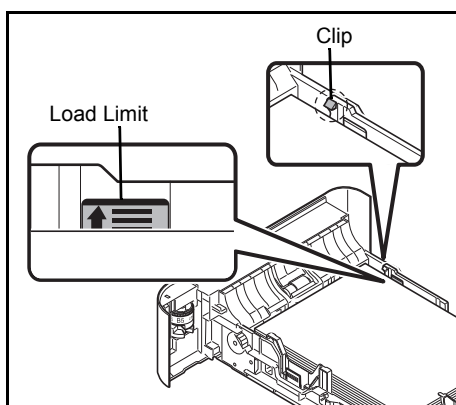

IMPORTANT Do not load paper above the load limits located on the paper width guide.

Before loading the paper, be sure that it is not curled or folded. Paper that is curled or folded may cause paper jams.

Ensure that the loaded paper does not exceed the load limit (see the illustration on the left).

Set the stack of paper so that it is under the clips (see the illustration on the left).

The paper length and width guides must be adjusted to the paper size. Loading the paper without adjusting these guides may cause skewed feeding and paper jams.

Be sure that the paper length and width guides rest securely against the paper. If there is a gap, readjust the guides to fit the paper.

- 8** Insert the paper cassette into the slot in the machine. Push it straight in as far as it will go.



Note If the machine will not be used for a prolonged period, protect all paper from humidity by removing it from the cassettes and sealing it in the paper storage bag.

- 9** Select the media type (plain, recycled, etc.) loaded in the cassette. (Refer to *Media Type (Setting the cassette paper type)* on page 4-29.)

Loading Paper into the MP (Multi-Purpose) Tray

The multi purpose tray will hold up to 100 sheets of A4 or smaller plain paper (80 g/m²).

The multi purpose tray accepts paper sizes from A4 to A6 and Hagaki and from Legal to Statement, 216 × 340 mm, Envelope Monarch, Envelope #10, Envelope DL, Envelope C5, Executive, Envelope #9, Envelope #6, ISO B5, Oufuku Hagaki, Oficio II, 16K, Folio, Youkei 2, Youkei 4 and Custom. Be sure to use the multi purpose tray when you print on any special paper.

IMPORTANT When using media types other than plain paper (such as recycled or colored paper), always specify the media type setting. (Refer to *Media Type (Paper type setting for the MP tray)* on page 4-27.) If you are using a paper weight of 106 g/m² or more, set the media type to Thick.

The capacity of the multi purpose tray is as follows.

- A4 or smaller plain paper (80 g/m²): 100 sheets
- Hagaki: 1 sheet
- OHP film: 1 sheet
- Envelope DL, Envelope C5, Envelope #10 (Commercial #10), Monarch, Youkei 4, Youkei 2: 5 sheets
- Folio: 20 sheets
- Thick paper: 5 sheets

 **Note** When you use special paper such as transparencies or thick paper, select the media type by referring to *Media Type (Paper type setting for the MP tray)* on page 4-27.

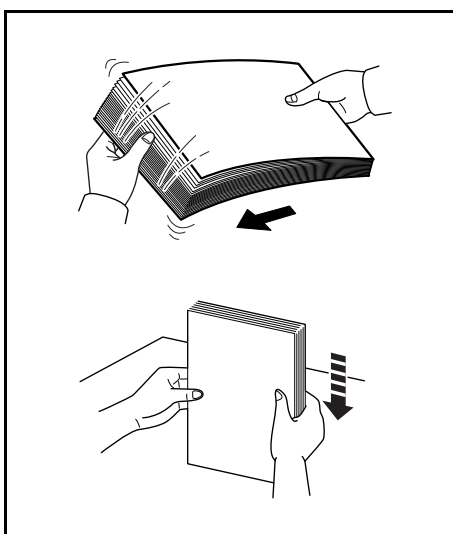

- 1 Fan the media (paper/transparencies), then tap it on a level surface to avoid media jams or skewed printing.

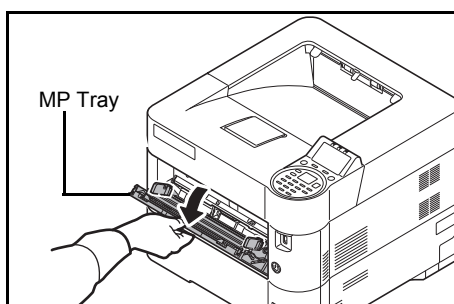

- 2 Pull the MP tray towards you until it stops.

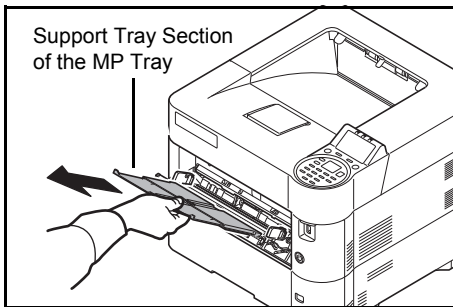

- 3** Pull out the support tray section of the MP tray.

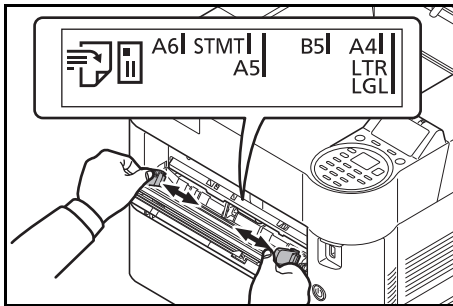

- 4** Adjust the position of the paper guides on the MP tray. Standard paper sizes are marked on the MP tray. For standard paper sizes, slide the paper width guides to the corresponding mark.

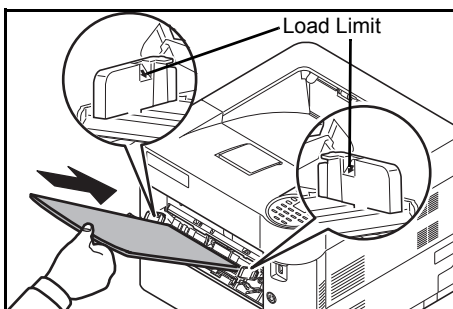

- 5** Align the paper with the paper guides and insert as far as it will go.

IMPORTANT Do not load more paper than will fit under the load limits on the inside of the MP tray.

Keep the side that was closest the package seal facing up.

Curled paper must be uncurled before use.

Straighten the top edge if it is curled.

When loading paper into the multi purpose tray, check that there is no paper left over in the tray from a previous job before loading the paper. If there is just a small amount of paper left over in the multi purpose tray and you want to add more, first remove the left-over paper from the tray and include it with the new paper before loading the paper back into the tray.

- 6** Set the MP tray paper size on the printer's operation panel. Refer to *MP Tray Set. (MP tray settings)* on page 4-26.

Loading Envelopes

5 envelopes may be loaded in the multi purpose tray.

Acceptable envelope sizes are as follows.

Acceptable Envelope	Size
Youkei 2	114 × 162 (mm)
Youkei 4	105 × 235 (mm)
Monarch	3 7/8" × 7 1/2"
Envelope #10 (Commercial #10)	4 1/8" × 9 1/2"
Envelope DL	110 × 220 (mm)
Envelope C5	162 × 229 (mm)
Executive	7 1/4" × 10 1/2"
Envelope #9 (Commercial #9)	3 7/8" × 8 7/8"
Envelope #6 (Commercial #6 3/4)	3 5/8" × 6 1/2"

Switching to Envelop Mode (FS-2100D/FS-2100DN)

To print on an envelope, follow the procedure below to switch to envelope mode.

 **Note** When the printing on envelopes is completed, return the envelope switch to its original position (at the bottom).

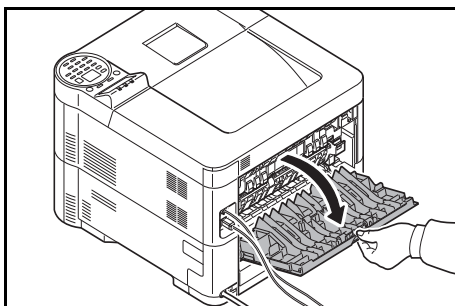

1 Open the rear cover.

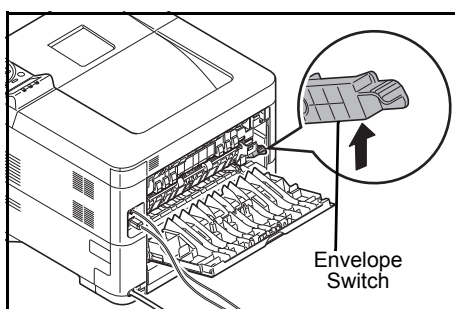

2 To print on an envelope, raise the envelope switch.



CAUTION The fuser unit inside the printer is hot. Do not touch it with your hands as it may result in burn injury.

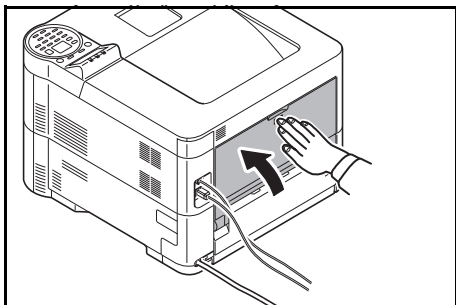

3 Close the rear cover.

Loading Envelopes into the MP (Multi-Purpose) Tray

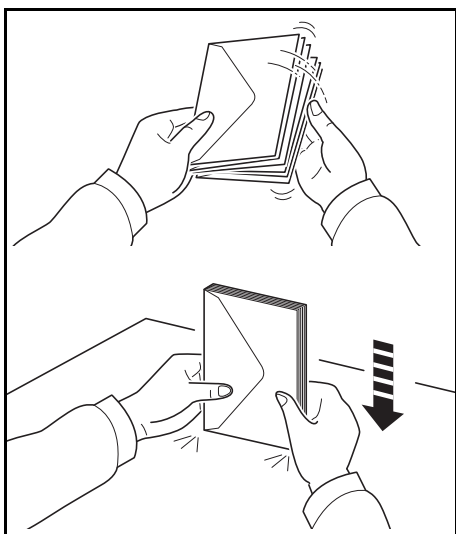

1 Fan the envelopes, then tap it on a level surface to avoid envelope jams or skewed printing.

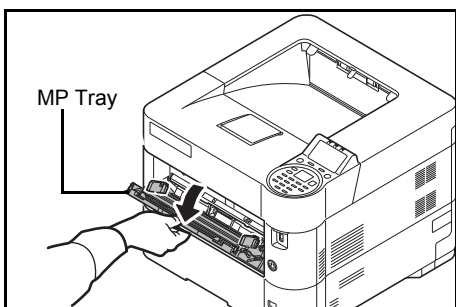

2 Pull the MP tray towards you until it stops.

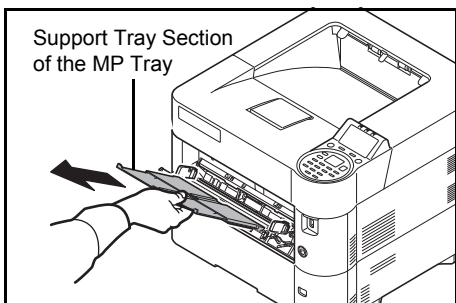

3 Pull out the support tray section of the MP tray.

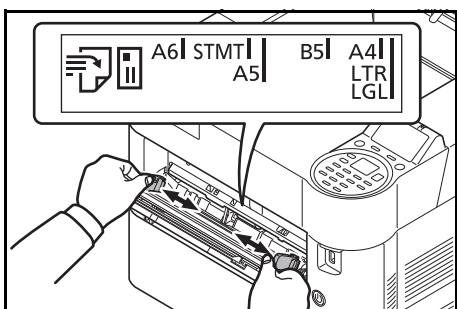

- 4 Adjust the position of the paper width guides on the MP tray.

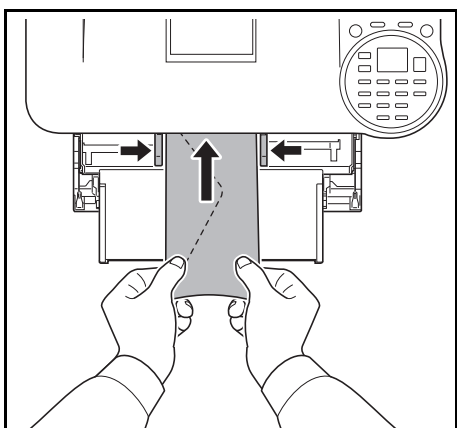

- 5 Align the paper with the paper guides and insert as far as it will go.

- 6 For portrait form envelopes, open the flap. Insert the envelope all the way along the width guides, keeping the printing side face-up and the edge with the flap facing towards you.

For landscape form envelopes, close the flap. Insert the envelope all the way along the width guides, keeping the printing side face-up and the edge with the flap facing towards the left.

When you load envelopes or cardstock in the multi purpose tray

Load envelope with the print side facing up.

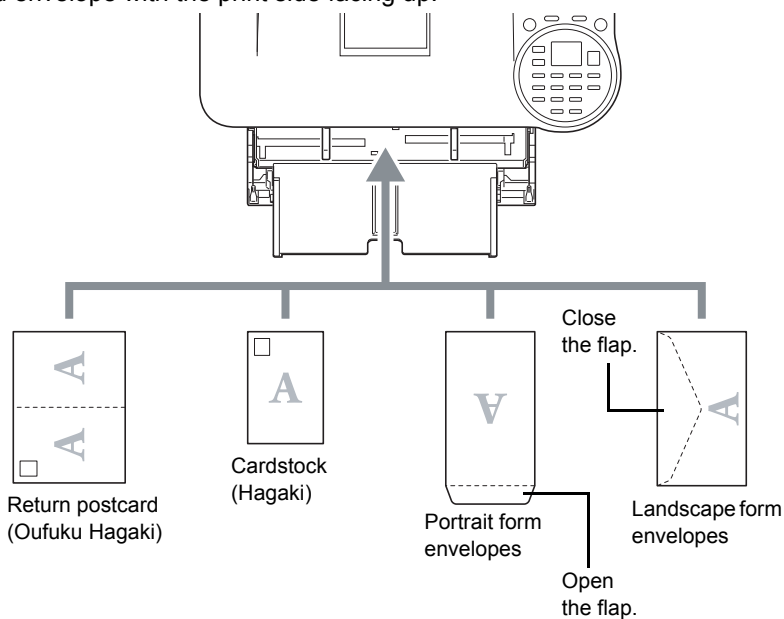

Note Use unfolded return postcard (Oufuku Hagaki).

IMPORTANT How to load envelopes (orientation and facing) will differ depending on the type of envelope. Be sure to load it in correctly, otherwise printing may be done in the wrong direction or on the wrong face.



Note When you load envelopes in the multi purpose tray, select the envelope type by referring to *Media Type (Paper type setting for the MP tray)* on page 4-27.

Paper stopper

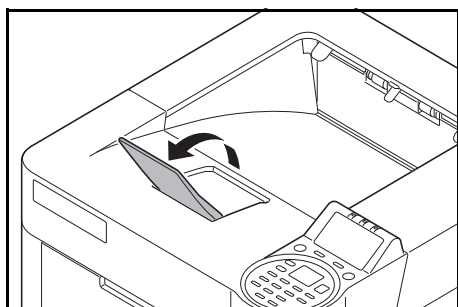

When using paper large than A4/Letter, open the paper stopper shown in the figure.

3 Printing

This chapter contains explanations on the following topics:

Printing from Applications	3-2
Canceling a Printing Job	3-2
Printer driver print settings screen	3-3
Registering a page size	3-4
Printer Driver Help	3-5
Printing functions	3-6

Printing from Applications

This section provides basic instructions for printing documents. Instructions are based on interface elements as they appear in Windows 7. To print the document from applications, install the printer driver on your computer from the supplied *Product Library* disc.

 **Note** Refer to *Installing Software* on page 2-7.

Follow the steps below to print documents from applications.

- 1 Create a document using an application.
- 2 Click **File** and select **Print** in the application. The **Print** dialog box appears.
- 3 Click the ▼ next to the Name field and select this machine from the list.
- 4 Enter the desired print quantity in the **Number of copies** box. Enter any number up to 999.
When there is more than one page, select **Collate** to print out one by one in the sequence of the page numbers.
- 5 Click **Properties**. The **Properties** dialog box appears.
- 6 Select the **Basic** tab and click **Print Size** to select the print size.
To print on the special paper such as thick paper or transparency, click **Media type** menu and select the media type.
- 7 Click **Source** and select the paper source.
 **Note** If you choose **Auto source selection**, paper is supplied automatically from the paper source loaded with paper of optimum size and type. To print on special paper such as envelopes or thick paper, place it on the multi purpose tray and select **MP Tray**.
- 8 Select paper orientation, either **Portrait** or **Landscape**, to match the orientation of the document.
Selecting **Rotated** will print the document rotated 180°.
- 9 Click **OK** to return to the **Print** dialog box.
- 10 Click **OK** to start printing.

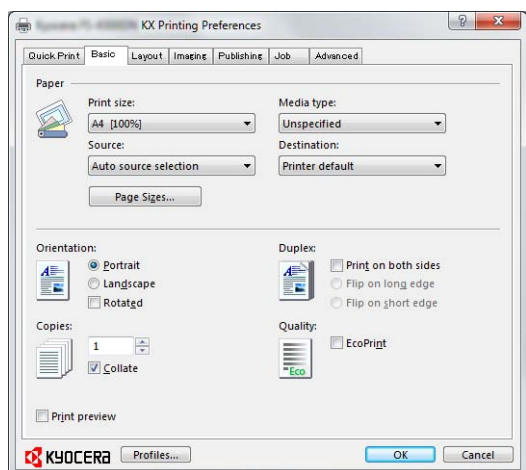

Canceling a Printing Job

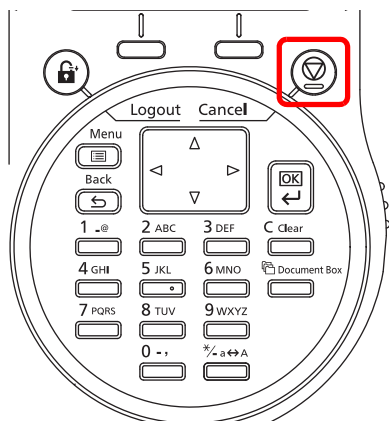

- 1 While the printer displays *Processing.*, press **[Cancel]**.
The *Job Cancel List* appears, showing the list of current print jobs.
- 2 Press ▲ or ▼ to display the desired job and then press **[OK]**.
When the *Job will be canceled. Are you sure?* message appears, press **[Yes]** (**[Left Select]**) to cancel the job or **[No]** (**[Right Select]**) to cancel this operation and continue printing.
When you cancel a job, *Canceling...* appears on the message display and printing stops after the page currently printing has been fed out.

Printer driver print settings screen

The printer driver print settings screen allows you to configure a variety of print-related settings. For more information, refer to the **Printer Driver User Guide** on the *Product Library* disc.

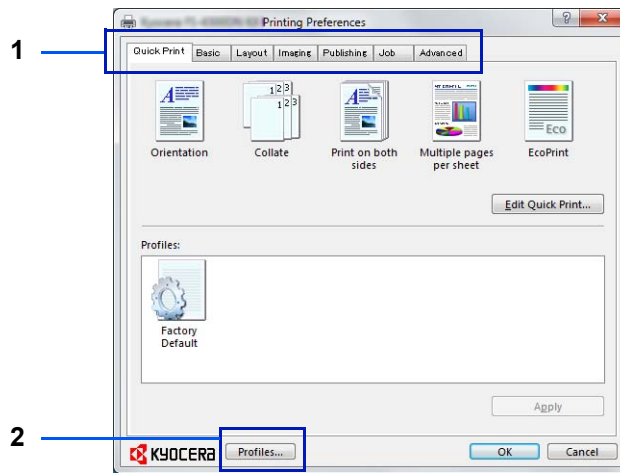

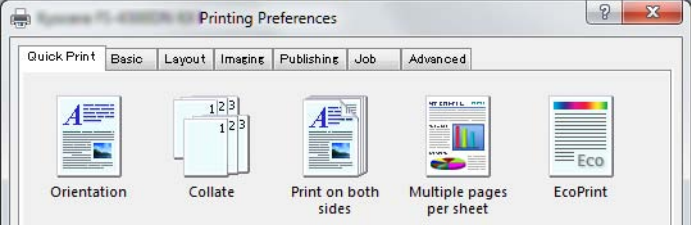
No.	Description
1	<p>Quick Print Provides icons that can be used to easily configure frequently used functions. Each time you click an icon, it changes to an image resembling the print results and applies the settings.</p>  <p>Basic This tab groups basic functions that are frequently used. You can use it to configure the paper size, media type, destination, and duplex.</p> <p>Layout This tab lets you configure settings for printing various layouts, including booklet printing, combine mode, poster printing, and scaling.</p> <p>Imaging This tab lets you configure settings related to the quality and grayscale adjustment of the print results.</p> <p>Publishing This tab lets you create covers and inserts for print jobs and put inserts between sheets of OHP film.</p> <p>Job This tab lets you configure settings for saving print data from the computer to the machine. Regularly used documents and other data can be saved to the machine for easy printing later. Since saved documents can be printed directly from the machine, this function is also convenient when you wish to print a document that you don't want others to see.</p> <p>Advanced This tab lets you configure settings for adding text pages or watermarks to print data.</p>
2	<p>Profiles Printer driver settings can be saved as a profile. Saved profiles can be recalled at any time, so it is a convenient practice to save frequently used settings.</p>

Registering a page size

When cardstock or an envelope is loaded in the Multi Purpose Tray, set the paper size and type and then register the paper size on the **Basic** tab of the print settings screen in the printer driver.

Once registered, the paper size can be selected from the **Page Size** menu.

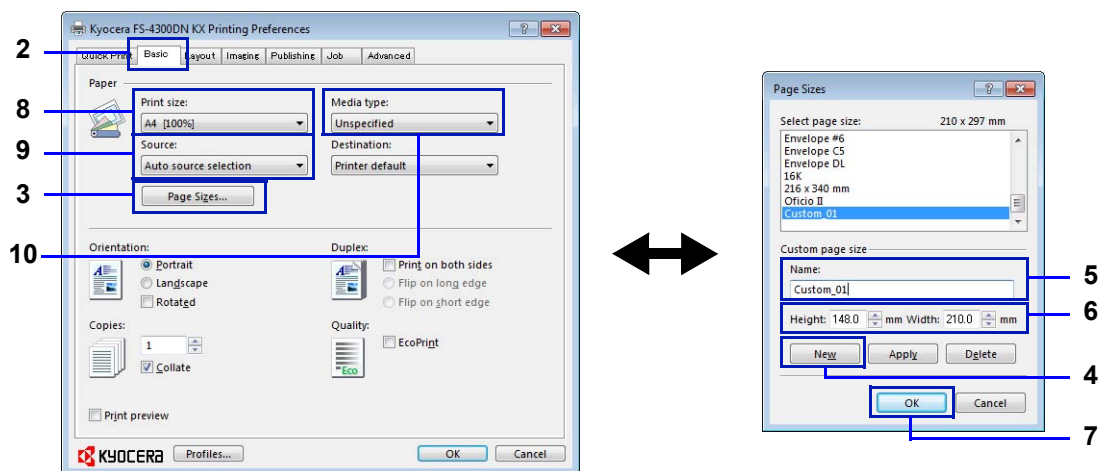

- 1 Display the print settings screen.
- 2 Click the **Basic** tab.
- 3 Click **Page Sizes...** to register the size.
- 4 Click **New**.
- 5 Enter the name of the paper.
- 6 Enter the paper size.
- 7 Click **OK**.
- 8 Select the page size (name) registered in steps 4 to 7.
- 9 Select **MP Tray**.
- 10 Select **Cardstock** or **Envelope**.

Printer Driver Help

The printer driver includes Help. To learn more about print settings, display the printer driver print settings screen and display Help using either of the methods explained below.

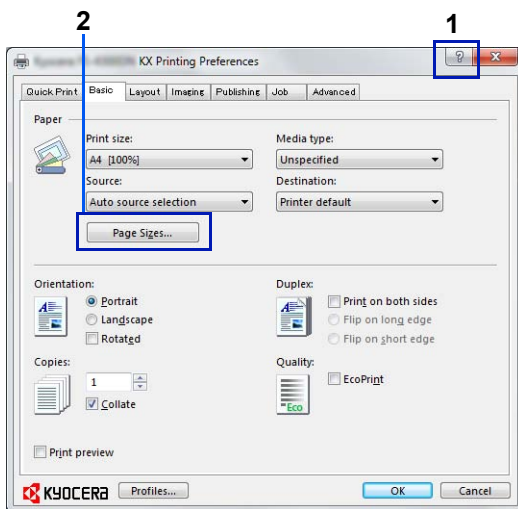

- 1 Click ? in the upper right corner of the screen.
- 2 Click the item you want to know about.

Changing the default printer driver settings (Windows 7)

The default printer driver settings can be changed. By selecting frequently used settings, you can omit steps when printing. The procedure is as follows.

- 1 Click **start**, and then click **Devices and Printers**.
- 2 Right-click the printer driver icon of the machine, and click **Properties** menu of the printer driver.
- 3 Click **Printing Preferences** on the **General** tab.
- 4 Select the default settings and click **OK**.

For the settings, refer to *Printer driver print settings screen on page 3-3*.

Printing functions

This section explains the useful functions which can be set with the Printer Driver. For more information, refer to the **Printer Driver User Guide**.

Half Speed Mode (Printer Driver Settings)

Half speed mode reduces the print speed to half the rated speed. When selected, the toner adheres better when printing on small size, thick, or textured paper. In addition, you can select the half speed mode to feed thick paper smoothly and avoid the paper jam. This mode may result in quieter printing.



Note Half speed mode applies to all media types except Transparency and Vellum.

Line Thinning (Printer Driver Settings)

Line thinning reduces the pen width of lines used for barcodes and line drawings. Drawing values controlled by an application are not changed.

Item	Description
Off (default setting)	Line thinning is not applied.
Barcodes	This setting reduces the pen width value for vertical and horizontal lines. It improves the readability of barcodes.
Fine lines	This setting reduces the pen width value for vertical, horizontal, and diagonal lines.
All	This setting reduces the pen width by a value of 1 for vertical, horizontal, and diagonal line used in barcodes or line drawings.



Note Line thinning is available when PCL XL is selected in the PDL Settings dialog box. When GDI compatible mode is selected in the PDL Settings dialog box, Line thinning is not available.

Correct fine line by device

Enable correction of pen width by device. This feature is available only on supported models.

Custom Box (Optional Feature)

Custom Box is a component box which you can create within the Document Box and store data for later retrieval.

You can create or delete a Custom Box, and data can be exchanged in various ways. To use a Custom Box, an optional SSD must be installed in the printer.

For more details on Custom Box operation, refer to *Custom Box on page 5-4*.

Job Box (Optional Feature)

Job Box holds temporary or permanent print data for use with job options including Private Print, Stored Job, Quick Copy and Proof and Hold which will be discussed later.

Four individual Job Boxes corresponding to these job options are already provided in the Document Box. These Job Boxes cannot be created or deleted by a user.

For more details on Job Box operation, refer to *Job Box on page 5-24*.

ThinPrint Activation (Optional Feature)

This printer can select whether or not to communicate using ThinPrint.

For more details on operation, refer to *Op Functions (Optional application settings)* on page 4-130.

Secure Pull Printing (Optional Feature)

Secure Pull Printing is a printing feature where a user pulls the print job to a printer selected after the job is spooled in a server. To use this feature, the following system environments are required.

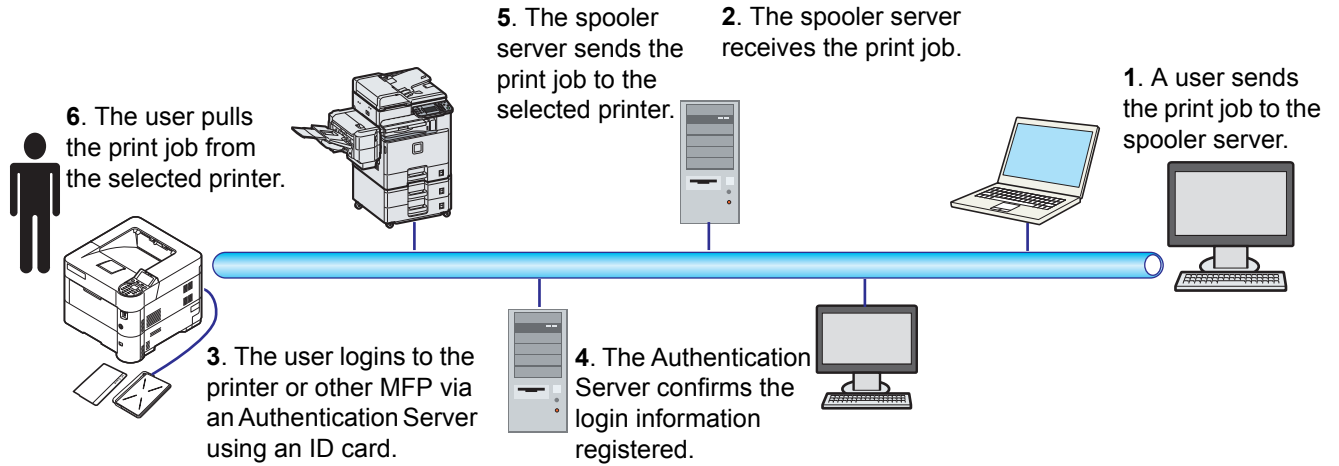

The Authentication server: KYOCERA Net Policy Manager (Optional Software) must be installed.

ID card and ID card reader: they are used to register and authenticate a user.

The Spooler server: it sends the print job to a selected printer after the user logs in.

For more details, contact your dealer or service representative.

4 Operation Panel

This chapter contains explanations on the following topics:

Message Display	4-2
Keys	4-4
Using the Menu Selection System	4-7
Setting a Mode Selection Menu	4-9
Report Print	4-10
USB Memory (USB memory selection)	4-17
Counter (Viewing the counter value)	4-25
Paper Settings	4-26
Print Settings	4-39
Network (Network settings)	4-54
Optional Network (Optional Network settings)	4-62
Device Common (Selecting/Setting the common device)	4-74
Security (Security function setting)	4-96
User/Job Account (User Login Setting/Job Account setting)	4-109
Adjust/Maint. (Adjust/Maintenance selection/setting)	4-128
Op Functions (Optional application settings)	4-130

Message Display

Messages indicating the status of the various printer operations are displayed on the message display.

Status Information

Message	Meaning
Please wait.	The printer is warming up and is not ready. When the printer is switched on for the first time, this message will take several minutes.
Please wait. Loading paper.	The paper in the cassette is being moved to a position where paper feed is possible. This message is sometimes displayed for a short period when the cassette is returned to its original position, for example, after paper is added. Note This message is not displayed on FS-2100D and FS-2100DN.
Please wait. Adding toner...	Toner is currently being replenished. This message may be displayed during continuous printing of a large volume of pages which require a large amount of toner such as with photographs, etc.
Ready to print.	The printer is ready to print.
Processing.	The printer is receiving data to print. This is also shown when the printer is reading an SD/SDHC memory card, USB memory, SSD or RAM disk.
Canceling...	Jobs inside the printer are being canceled. To cancel a job, refer to <i>Canceling a Printing Job</i> on page 4-4.

Error Codes

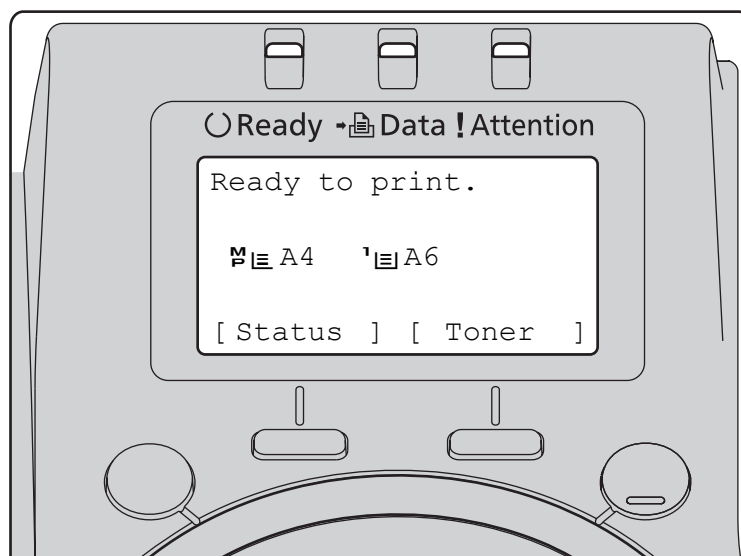

For information on error code and errors where the printer requires the operator's attention, refer to *Error Messages* on page 8-5.

Indicators in Message Display



Ready, Data, and Attention Indicators

The following indicators light during normal operation and whenever the printer needs attention. Depending on the status of lighting, each indicator has the following meaning:

Indicator	Description
 Ready	<p>Flashing. Indicates an error that you can resolve. For details, refer to <i>Troubleshooting on page 8-1</i>. Or, the printer is in Auto Sleep. The printer wakes from Auto Sleep whenever a print job is received. The printer then warms up and goes on-line. For details on Auto Sleep, refer to <i>Sleep Timer (Sleep timer timeout time) on page 4-90</i>.</p> <p>On. Indicates that the printer is ready and on-line. The printer prints the data it receives.</p> <p>Off. Indicates that the printer is off-line because printing is manually stopped or automatically stopped due to an error condition. Data can be received but will not be printed. For details, refer to <i>Error Messages on page 8-5</i> if printing is automatically stopped when an error condition has occurred.</p>
 Data	<p>Flashing. Indicates that data is being received.</p> <p>On. Indicates either that data received is being processed before printing starts, or that the optional SSD or SD/SDHC memory card is being accessed.</p>
 Attention	<p>Flashing. If <code>Please wait</code> is displayed, the printer is warming up. Or, the printer cannot print for some reason (e.g. there is no paper in the cassette). Check the message display and carry out the required action. For details, refer to <i>Error Messages on page 8-5</i>.</p> <p>On. The printer cannot print due to an error. Check the message display and carry out the required action. For details, refer to <i>Error Messages on page 8-5</i>.</p>

Keys

The operation panel keys are used to configure the printer operation. Note that certain keys have a secondary function.

Cancel Key



This key is used to:

- Cancel a printing job.
- Stop the alarm sound.

Canceling a Printing Job

- 1 While the printer displays `Processing.`, press **[Cancel]**.

The `Job Cancel List` appears, showing the list of current print jobs.

- 2 Press Δ or ∇ to display the desired job and then press **[OK]**.

When the `Job will be canceled. Are you sure?` message appears, press `[Yes]` (**[Left Select]**) to cancel the job or `[No]` (**[Right Select]**) to cancel this operation and continue printing.

When you cancel a job, `Canceling...` appears on the message display and printing stops after the page currently printing has been fed output.

Logout Key



- If user control is set then please log out by pressing **[Logout]** after operations are completed.

Menu Key

Menu



- **[MENU]** lets you enter the menu system to change the setup and printing environment of the printer.

Back Key

Back



- Cancels the menu setting currently displayed and returns to the menu for the previous step.

Arrow Keys

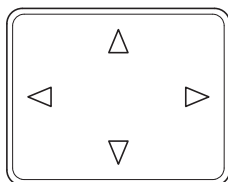

- The four arrow keys are used in the menu system to access an item or enter numeric values.

OK Key



- Finalize settings of numeric values and other selections.

Numeric Keys

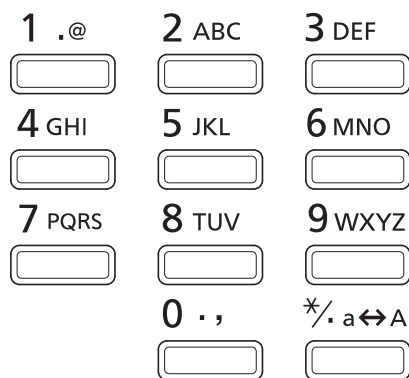

- Enter numbers and symbols.

Clear Key

C Clear

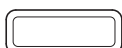

- Clears entered numbers and characters.

Document Box Key

 Document Box

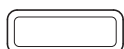

- Press this key when using Document Box. For details, refer to *Document Box on page 5-1*.

Left Select Key / Right Select Key



- These keys only function when the respective key tabs are shown in the message display. Pressing the key executes the function shown in the message display.

Pressing the key executes the function shown in the message display.

E.g.:

When the menu shown below is displayed, pressing **[Left Select]** ([Yes]) prints the file selected. Pressing **[Right Select]** ([No]) stops printing and returns to the menu for the previous step.

```
Print.  
Are you sure?  
  
[ Yes ] [ No ]
```

- These keys only function when the paper jam message has appeared on the message display. A help message will then appear to facilitate jam clearing in the location.

Using the Menu Selection System

Menu Selection System

This section explains how to use the menu selection system.

[Menu] on the operation panel allows you to use the menu to configure the printer settings to your specific needs. Settings can be made when *Ready to print.*, *Please wait.* or *Processing.* is indicated on the printer message display.

 **Note** Settings that are received from application software and the printer driver will take priority over settings made in the operation panel.

Entering the Mode Selection Menu

Press **[Menu]** when *Ready to print.* is indicated on the printer message display.

The mode selection menu is displayed.

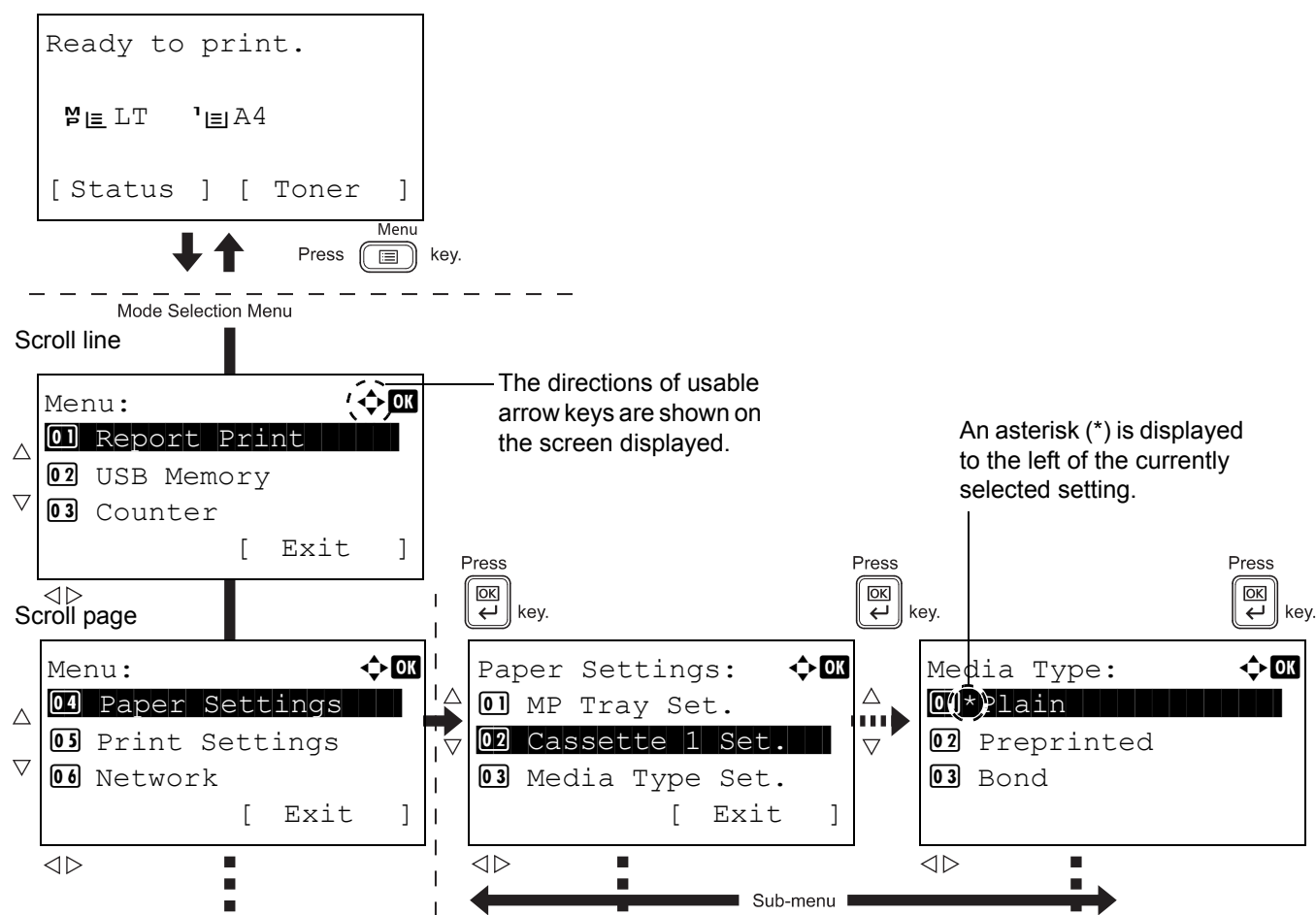

 **Note** Only when USB memory is installed, *USB Memory* is displayed. *Network* is only displayed on network compatible models.

Selecting a Menu

The mode selection menu is hierarchical. Press Δ , ∇ , \triangleleft or \triangleright to display the desired menu.

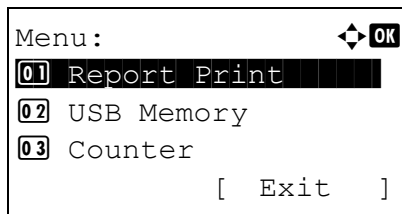

- If [\blacklozenge] appears in the top-right of the screen, you can use the Δ and ∇ to scroll up and down through the menu options one line at a time, and the \triangleleft and \triangleright to move between menu options one page at a time.

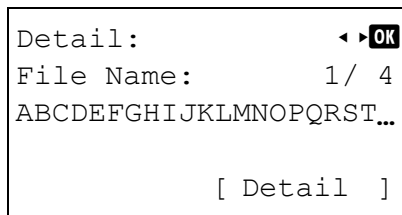

- If [\blacktriangleleft] appears in the top-right of the screen, you can use the \triangleleft and \triangleright to switch between pages.

To return to the menu one level up, press **[Back]**.

Setting a Menu

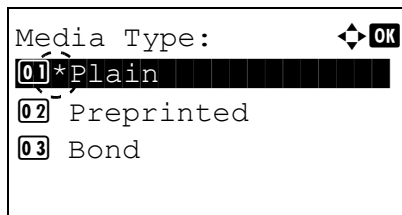

Select the desired menu and press **[OK]**. You can now select options in the menu. Press Δ , ∇ , \triangleleft or \triangleright to select or enter the desired setting and then press **[OK]** to confirm your selection.

If you are choosing from a list of settings, an asterisk (*) is displayed to the left of the currently selected setting.

Canceling Menu Selection

If you press **[Menu]** when a menu is selected, the message display returns to Ready to print.

Setting a Mode Selection Menu

This section explains the setting procedures used for each menu item in the mode selection menu.

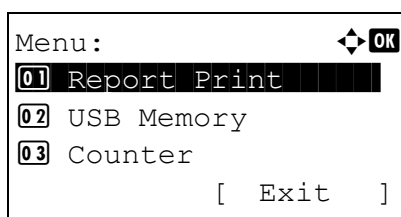

1 While the printer displays `Ready to print., Please wait. and Processing.,` press **[MENU]**. The mode selection menu is displayed.

2 Each time you press Δ or ∇ , the selection changes.

- Report Print...4-10
- USB Memory...4-17
- Counter...4-25
- Paper Settings...4-26
- Print Settings...4-39
- Network...4-54
- Optional Network...4-62
- Device Common...4-74
- Security...4-96
- User/Job Account...4-109
- Adjust/Maint. ...4-128
- Op Functions...4-130



Note `Optional Network` is only displayed when a network interface kit (IB-50) or wireless network interface kit (IB-51) is installed as an option.

Report Print

Prints a report. The options available in the Report Print menu are as follows:

- Menu Map (Printing a menu map)...4-10
- Status Page (Printing a printer's status page)...4-12
- Font List (Printing a list of the printer's fonts)...4-14
- RAM File List (Printing a list of the files on the RAM disk)...4-15
- SSD File List (Printing a list of the files on the SSD)...4-15
- SD Card FileList (Printing a list of the files on an SD/SDHC memory card)...4-16

- 1 Press **[MENU]**.
- 2 Press Δ or ∇ to select `Report Print`.
- 3 Press **[OK]**. The `Report Print` menu appears showing a list of the types of report that can be printed. Note that report types shown may vary depending on which optional units are installed in the printer.

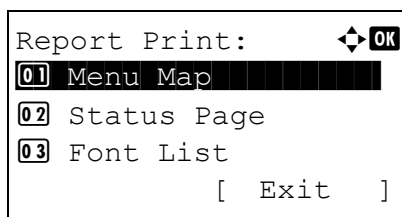

Menu Map (Printing a menu map)

The printer prints a full list of the menu selection system menu map.

- 1 In the `Report Print` menu, press Δ or ∇ to select `Menu Map`.
- 2 Press **[OK]**. A confirmation message is displayed.



Note When Job Accounting is set but user login is not set, the screen for entering Job Accounting information is displayed. Enter the Account ID and press **[OK]**.

- 3 Press **[Yes]** (**[Left Select]**). The message `Accepted.` appears and the printer prints the menu map.

Pressing **[No]** (**[Right Select]**) returns to the `Report Print` menu without printing the menu map.

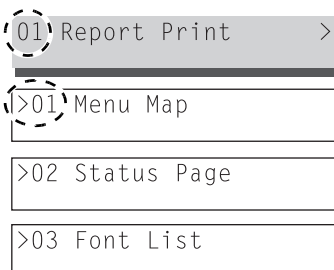
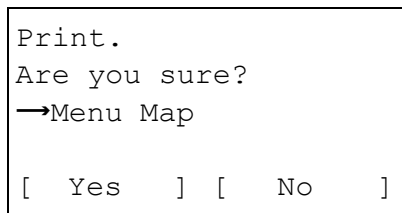

Note The Menu numbers are printed on the Menu Map outputted. It is possible to use the numeric keys to enter the Menu number and display the settings required.

e.g.: Displaying the Menu Map printing menu

- 1 Press **[Menu]**.
- 2 Press **[1]** on the Numeric Keys. The `Report Print` menu appears.
- 3 Press **[1]** on the Numeric Keys. A confirmation message is displayed.

Menu Map Sample

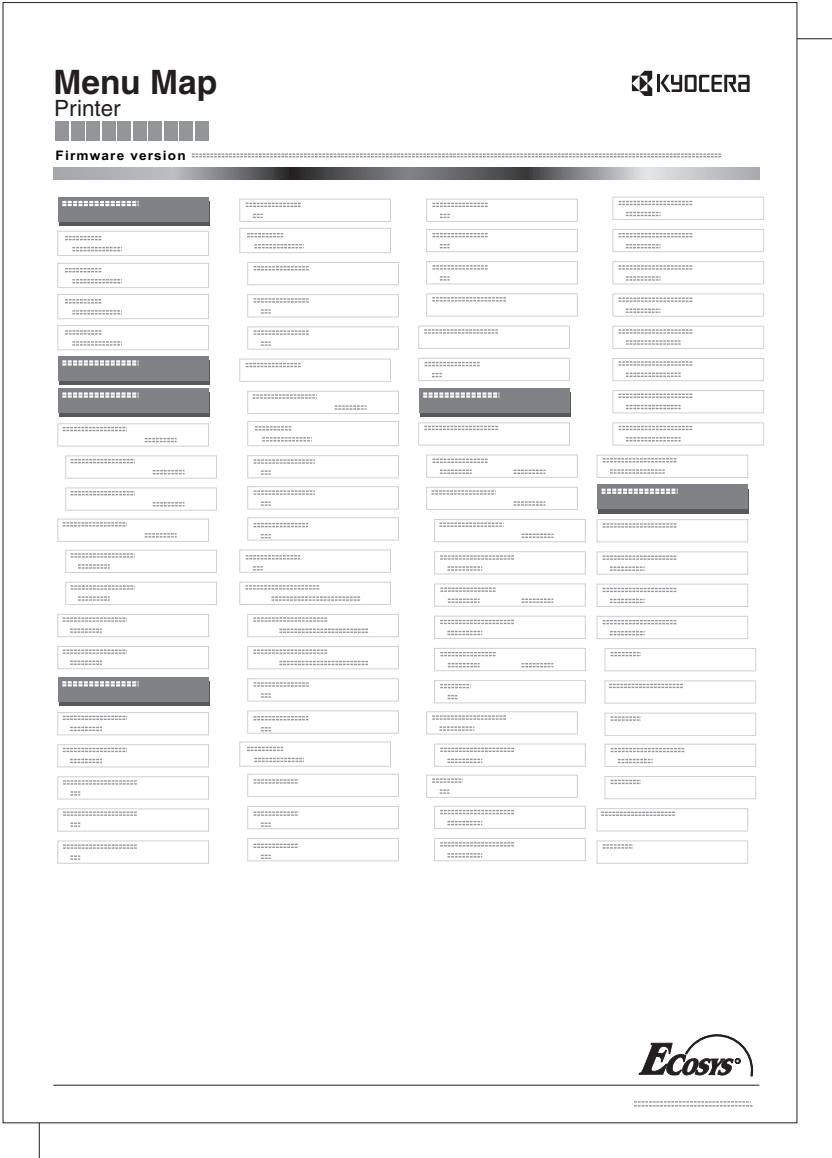

Status Page (Printing a printer's status page)

You can check the printer's current status and option settings by printing a status page.

- 1 In the `Report Print` menu, press Δ or ∇ to select `Status Page`.
- 2 Press **[OK]**. A confirmation message is displayed.



Note When Job Accounting is set but user login is not set, the screen for entering Job Accounting information is displayed. Enter the Account ID and press **[OK]**.

- 3 Press **[Yes]** (**[Left Select]**). The message `Accepted.` appears and the printer prints the status page.

Pressing **[No]** (**[Right Select]**) returns to the `Report Print` menu without printing the status page.

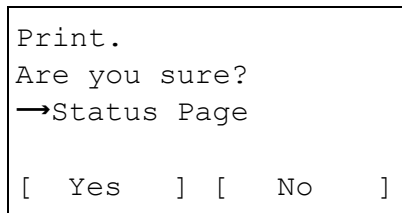

Understanding the Status Page

The numbers in the following diagram refer the items explained below the diagram. The items and values on the status page may vary depending on the printer's firmware version.

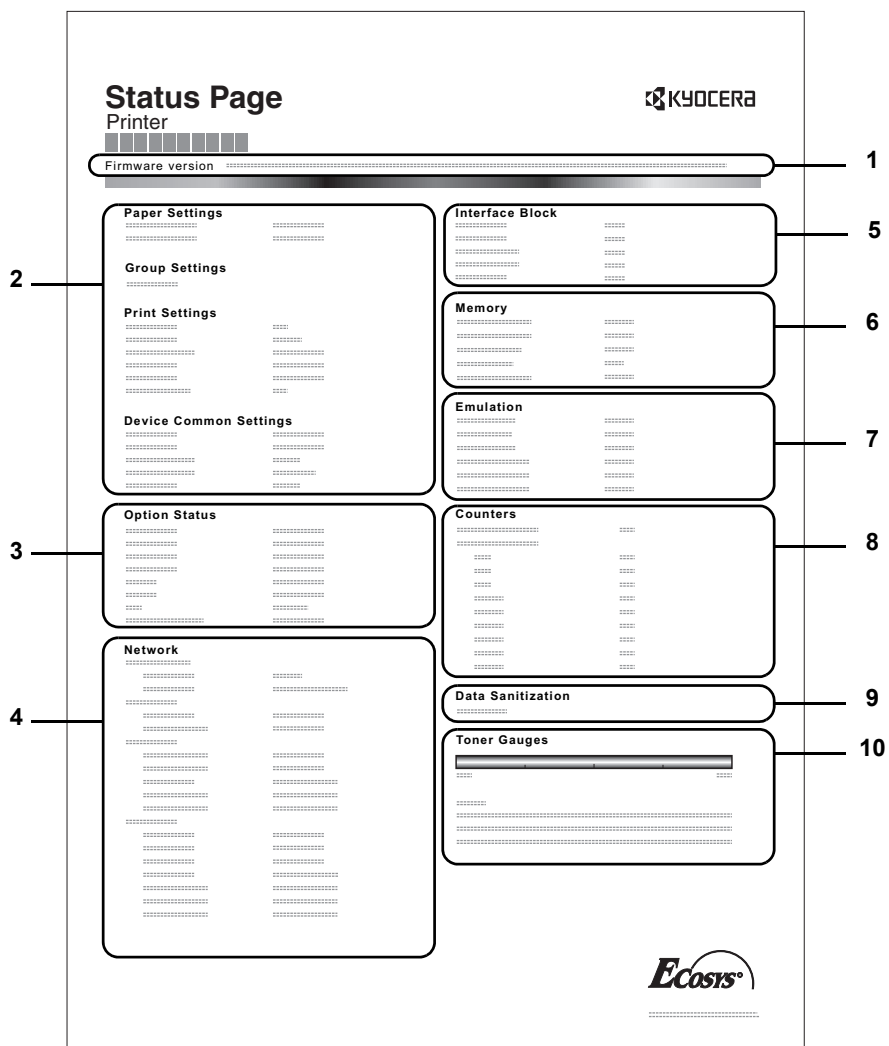

1 Firmware Version

This item shows the version and release date of the printer firmware.

2 Printer Settings Information

This item shows various printer settings for hardware-related items:

- MP tray paper size and type
- Paper cassette size and type
- Copies
- EcoPrint
- KIR mode
- Resolution
- MP tray priority
- Sleep level
- Sleep time
- Power off time
- Form feed timeout time
- MP tray empty

3 Installed Options

This item shows the options installed in the printer:

- Paper Feeder
- Bulk Feeder
- SD/SDHC memory card
- SSD
- Card Authentication Kit (B)
- Data Security Kit (E)
- UG-33

4 Network Status

This item shows the IP address, subnet mask address, and default gateway address for the network interface card in the printer.



Note Only displayed on network compatible models.

5 Interface Information

This information shows the block status for items including the USB memory slot and USB interface. When connected by network interface card (NIC), block status is shown for an optional interface.

6 Memory

This item shows:

- Standard memory in the printer
- Option memory slot status in megabytes
- Total memory in the printer
- Current status of the RAM disk

7 Emulation

This item shows all available emulations of the printer. The KPDL (AUTO) or PCL 6 emulation is set as the default when the printer is shipped from the factory. The emulations are:

- PCL 6

- KPDL
- Line Printer
- IBM Proprinter
- EPSON LQ-850

8 Page Information

This shows counter information. Total printed page count and total page count of each paper size.

9 Data Sanitization

The status of the Data Sanitization implementation is displayed.

10 Consumable Status

This item shows the approximate level of remaining toner. When the value is 100, the toner container is full. The closer to 0, the smaller the amount of remaining toner.

Font List (Printing a list of the printer's fonts)

To help you decide in selecting a font, you can printout lists of the internal fonts or the optional fonts.

- 1** In the `Report Print` menu, press Δ or ∇ to select `Font List`.
- 2** Press **[OK]**. A confirmation message is displayed.



Note When Job Accounting is set but user login is not set, the screen for entering Job Accounting information is displayed. Enter the Account ID and press **[OK]**.

- 3** Press **[Yes]** (**[Left Select]**). The message `Accepted.` appears and the printer prints the font list.

Pressing **[No]** (**[Right Select]**) returns to the `Report Print` menu without printing the font list.

```
Print.
Are you sure?
→Font List

[ Yes ] [ No ]
```

Font List Sample

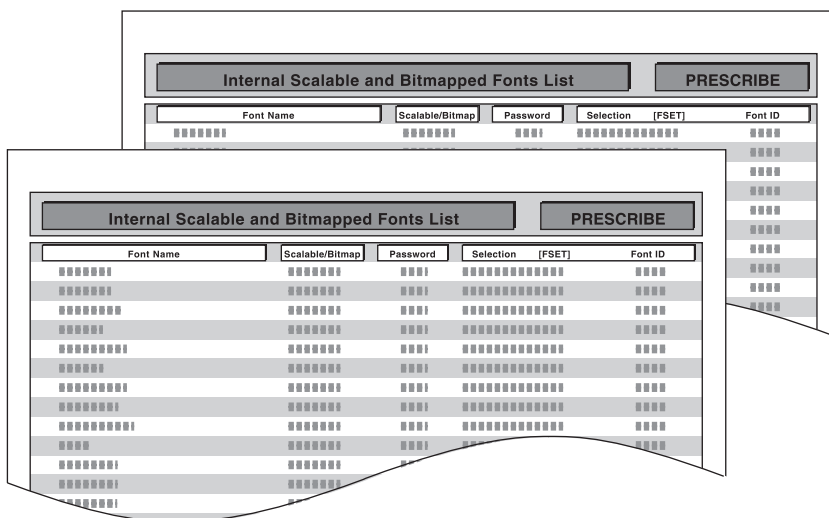

RAM File List (Printing a list of the files on the RAM disk)

This allows you to print a list of the files on the RAM disk.

IMPORTANT This is displayed when RAM Disk Mode is set to On.

1 In the `Report Print` menu, press Δ or ∇ to select `RAM File List`.

2 Press **[OK]**. A confirmation message is displayed.



Note When Job Accounting is set but user login is not set, the screen for entering Job Accounting information is displayed. Enter the Account ID and press **[OK]**.

3 Press `[Yes]` (**[Left Select]**). The message `Accepted.` appears and the printer prints a list of the files held in the RAM disk.

Pressing `[No]` (**[Right Select]**) returns to the `Report Print` menu without printing the RAM disk file list.

```
Print.
Are you sure?
→RAM File List

[ Yes ] [ No ]
```

SSD File List (Printing a list of the files on the SSD)

This allows you to print a list of the files on the SSD.

IMPORTANT This is only displayed when the printer has an optional SSD (HD-6) installed and the drive is correctly formatted.

1 In the `Report Print` menu, press Δ or ∇ to select `SSD File List`.

2 Press **[OK]**. A confirmation message is displayed.



Note When Job Accounting is set but user login is not set, the screen for entering Job Accounting information is displayed. Enter the Account ID and press **[OK]**.

3 Press `[Yes]` (**[Left Select]**). The message `Accepted.` appears and the printer prints a list of the files held on the SSD.

Pressing `[No]` (**[Right Select]**) returns to the `Report Print` menu without printing the SSD file list.

```
Print.
Are you sure?
→SSD File List

[ Yes ] [ No ]
```

SD Card FileList (Printing a list of the files on an SD/SDHC memory card)

This allows you to print a list of the files on an SD/SDHC memory card.

IMPORTANT This message will be displayed only when the SD/SDHC memory card is installed in the printer and properly formatted.

1 In the `Report Print` menu, press Δ or ∇ to select `SD Card FileList`.

2 Press **[OK]**. A confirmation message is displayed.



Note When Job Accounting is set but user login is not set, the screen for entering Job Accounting information is displayed. Enter the Account ID and press **[OK]**.

3 Press `[Yes]` (**[Left Select]**). `Accepted.` appears and the printer prints a list of the files held on the SD/SDHC memory card.

Pressing `[No]` (**[Right Select]**) returns to the `Report Print` menu without printing the SD/SDHC memory card file list.

```
Print.  
Are you sure?  
→SD Card FileList  
  
[ Yes ] [ No ]
```

USB Memory (USB memory selection)

This specifies the settings for removing the USB memory and printing USB memory content.

The **USB Memory** menu automatically appears when you install the USB memory.

IMPORTANT This message is only displayed when the USB host block and USB Storage block are set to **Unblock**. For more information, please refer to *I/F Block Set. (External interface block setting)* on page 4-103.

The options available in the USB Memory menu are as follows:

- Print File (Printing and checking the files in the USB memory)...4-17
 - Display of File List...4-17
 - Print File (Printing the selected file)...4-18
- Print Function Settings...4-19
 - Duplex (Setting the duplex printing)...4-19
 - EcoPrint (Selecting the EcoPrint mode)...4-19
 - File Name Entry (Entering a file name)...4-20
 - JobFinish Notice (Setting for notification when jobs are finished.)...4-21
 - Encrypted PDF (Entering the PDF password)...4-21
 - TIFF/JPEG Size (Adjusting the TIFF/JPEG file print out size)...4-22
 - XPS FitTo Page (Adjusting the XPS file print out size)...4-23
 - Detail (Shows the details of the selected file)...4-23
- Remove Memory (Removing the USB memory)...4-24

- 1** Press **[MENU]**.
- 2** Press Δ or ∇ to select **USB Memory**.
- 3** Press **[OK]**. The **USB Memory** menu appears showing a list of available actions.

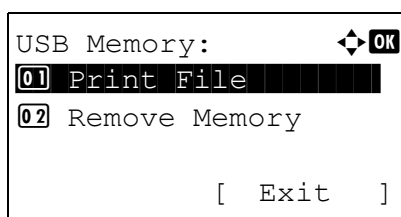

Print File (Printing and checking the files in the USB memory)

This displays a list of the files and folders in the USB memory. You can print the select file. You can also view the details of the selected file or folder.

The options available in the Print File menu are as follows:

- Display of File List...4-17
- Print File (Printing the selected file)...4-18

Display of File List

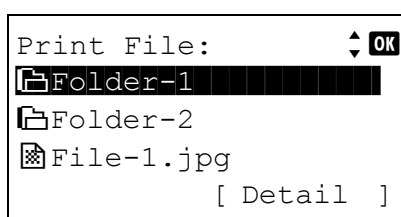

- 1** In the **USB Memory** menu, press Δ or ∇ to select **Print File**.
- 2** Press **[OK]**. File List appears showing a list of the files and folders in the USB memory.

If there are 4 or more files and folders, pressing Δ or ∇ repeatedly scrolls up or down through the list.

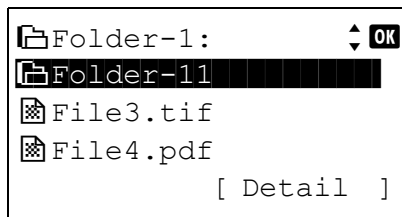

Press Δ or ∇ to select a folder and then press **[OK]**.
The folders and files in the selected folder are displayed.

IMPORTANT Print File only shows the PDF, TIFF, JPEG and XPS files in the USB memory. Up to 3 folder levels can be displayed. Depending on the USB memory capacity and the number of files, the list may take some time to appear.

Print File (Printing the selected file)

You can use this to specify printing for files in the USB memory.

- 1 Use the procedure described in *Print File (Printing and checking the files in the USB memory)* on page 4-17 to display a list of the files in the folder containing the file you want to print.
- 2 Press Δ or ∇ to select the file you want to print.
- 3 Press **[OK]**. The **Copies** menu screen appears.
 -  **Note** When Job Accounting is set but user login is not set, the screen for entering Job Accounting information is displayed. Enter the Account ID and press **[OK]**.
- 4 To print 2 or more copies, Use the numeric keys or press Δ or ∇ to set the number of copies to be printed.

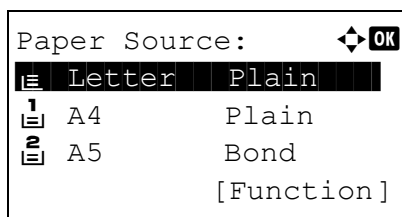
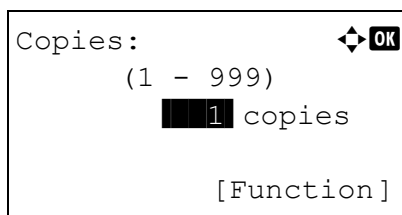

- 5 Press **[OK]**. The **Paper Source** menu screen appears.
 -  **Note** **[Function] ([Right Select])** can be pressed to change the print settings. For details, refer to *Print Function Settings* on page 4-19.
- 6 Press Δ or ∇ to select the tray containing the paper you want to use.
- 7 Press **[OK]**. The message **Accepted.** appears and printing begins.

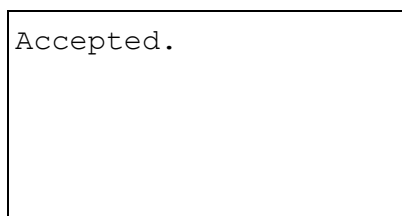

Print Function Settings

When printing, the print settings can be changed.

Options available in Print Function Settings are as follows:

- Duplex (Setting the duplex printing)...4-19
- EcoPrint (Selecting the EcoPrint mode)...4-19
- File Name Entry (Entering a file name)...4-20
- JobFinish Notice (Setting for notification when jobs are finished.)...4-21
- Encrypted PDF (Entering the PDF password)...4-21
- TIFF/JPEG Size (Adjusting the TIFF/JPEG file print out size)...4-22
- XPS FitTo Page (Adjusting the XPS file print out size)...4-23

Duplex (Setting the duplex printing)

Set duplex printing. For details, refer to *Duplex (Setting the duplex printing)* on page 4-41.

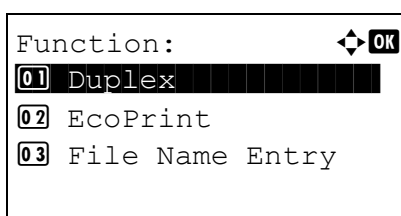

- 1 In the Copies menu or the Paper Source menu, press [Function] (**[Right Select]**). The Function menu appears.

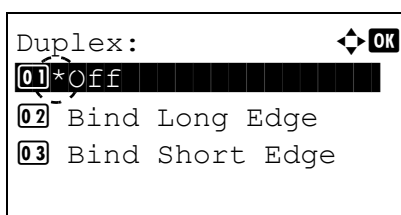

- 2 Press Δ or ∇ to select Duplex.
- 3 Press **[OK]**. The Duplex screen appears showing the list of available duplex printing modes.

- 4 Press Δ or ∇ to select the desired duplex printing mode. The message display toggles through the following:
 - Off (default)
 - Bind Long Edge
 - Bind Short Edge
 Selecting Off disables duplex printing.

- 5 Press **[OK]**. The duplex printing mode is set and the Function menu reappears.

EcoPrint (Selecting the EcoPrint mode)

Set EcoPrint mode. For details, refer to *EcoPrint (Selecting the EcoPrint mode)* on page 4-48.

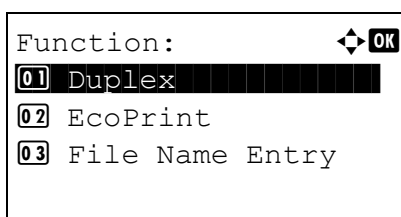

- 1 In the Copies menu or the Paper Source menu, press [Function] (**[Right Select]**). The Function menu appears.

- 2 Press Δ or ∇ to select EcoPrint.

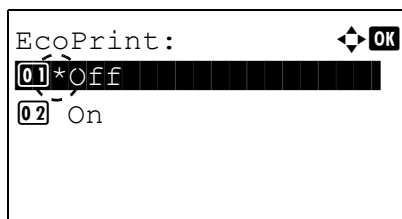

3 Press **[OK]**. The `EcoPrint` screen appears.

4 Press Δ or ∇ to select the `EcoPrint` mode.

5 Press **[OK]**. The `EcoPrint` mode is set and the `Function` menu reappears.

File Name Entry (Entering a file name)

Enter the file name. The file name entered is displayed as the Job Name in the Job Status and Job Log.

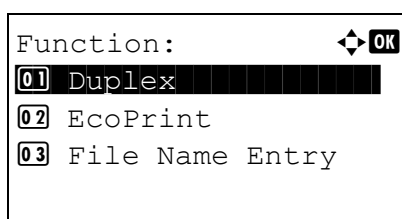

1 In the `Copies` menu or the `Paper Source` menu, press `[Function]` (**[Right Select]**). The `Function` menu appears.

2 Press Δ or ∇ to select `File Name Entry`.

3 Press **[OK]**. The `File Name Entry` screen appears.

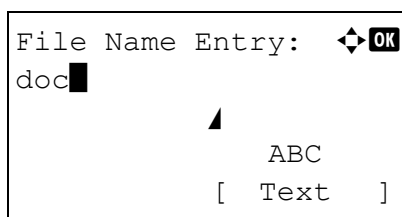

4 Enter the file name using the numeric keys.



Note Up to 32 characters can be entered. For details on entering characters, refer to *Character Entry Method on page A-2*.

5 Press **[OK]**. The `Additional Info.` screen appears.

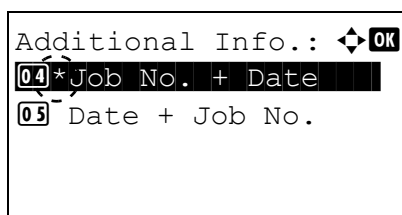

6 Press Δ or ∇ to select from the additional information that can be set for the file name.

The following settings can be selected.

- None (No additional information is added.)
- Date (To add the date.)
- Job No. (To add the Job Number.)
- Job No. + Date (To add the Job Number and date.)
- Date + Job No. (To add the date and Job Number.)

7 Press **[OK]**. Register the file name and the `Function` menu reappears.

JobFinish Notice (Setting for notification when jobs are finished.)

Notification that a job has finished is sent by E-Mail.

 **Note** To send E-mail from this machine, set the SMTP and POP3 settings to On. For details, refer to the *Protocol Detail (Detailed settings for the network protocol)* on page 4-60.

It is necessary to register a mail server. For the method for setting the server, refer to the section on *Command Center RX* on page 2-17.

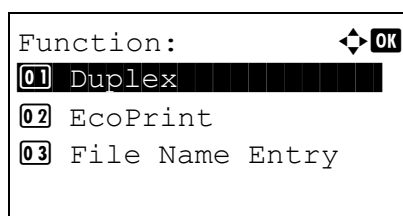

1 In the **Copies** menu or the **Paper Source** menu, press [Function] (**[Right Select]**). The **Function** menu appears.

2 Press Δ or ∇ to select **JobFinish Notice**.

3 Press **[OK]**. The **JobFinish Notice** screen appears.

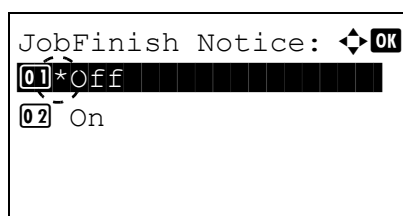

4 Press Δ or ∇ to select **On**.

5 Press **[OK]**. The **Address Entry** screen appears.

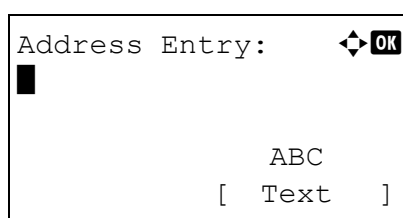

6 Enter the address to be notified.

 **Note** Up to 128 characters can be entered. For details on entering characters, refer to *Character Entry Method* on page A-2.

When user login administration is enabled, the address of the logged in user is entered.

7 Press **[OK]**. Register the address and the **Function** menu reappears.

Encrypted PDF (Entering the PDF password)

The password of a PDF file can be entered.

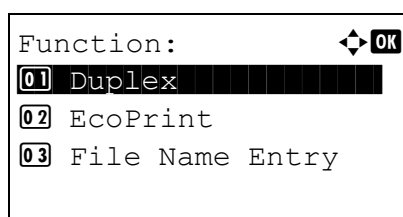

1 In the **Copies** menu or the **Paper Source** menu, press [Function] (**[Right Select]**). The **Function** menu appears.

2 Press Δ or ∇ to select **Encrypted PDF**.

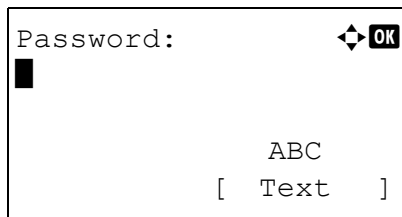

- Press **[OK]**. The Password entry screen appears.

- Enter the password for the PDF file.



Note Up to 256 characters can be entered. For details on entering characters, refer to *Character Entry Method* on page A-2.

- Press **[OK]** to enter the password and the Function menu reappears.

TIFF/JPEG Size (Adjusting the TIFF/JPEG file print out size)

Use this setting to select the printing method used when TIFF or JPEG files are printed directly.

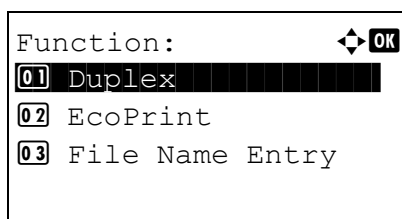

- In the Copies menu or the Paper Source menu, press [Function] (**[Right Select]**). The Function menu appears.

- Press Δ or ∇ to select TIFF/JPEG Size.

- Press **[OK]**. The TIFF/JPEG Size screen appears.

The options available in TIFF/JPEG Size are as follows:

- Paper Size (default)
Images are resized so that they fill the paper size when printed.
- Image Resolution
Image files are printed at the resolution specified in the resolution information. Images with no resolution information are printed using the Paper Size setting.
- Print Resolution
Images are printed using a 1-to-1 correspondence between the image file pixels and printed dots. For example, the printed size of a 600 × 300-pixel image file is 1 inch × 1/2 inch.

- Press Δ or ∇ to select whether TIFF/JPEG Size mode is enabled.

- Press **[OK]**. The TIFF/JPEG Size setting is set and the Function menu reappears.



Note Images are automatically rotated during printing to provide a closer match between the aspect ratios of the image file and the paper used for printing.

XPS FitTo Page (Adjusting the XPS file print out size)

Select **On** in this setting to enlarge or reduce XPS files to fit the printable area during printing.

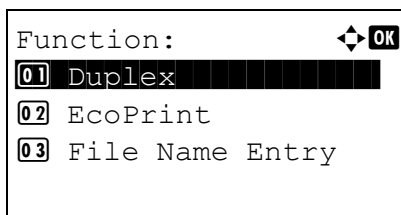

1 In the **Copies** menu or the **Paper Source** menu, press [Function] (**[Right Select]**). The **Function** menu appears.

2 Press Δ or ∇ to select **XPS FitTo Page**.

3 Press **[OK]**. The **XPS FitTo Page** screen appears.

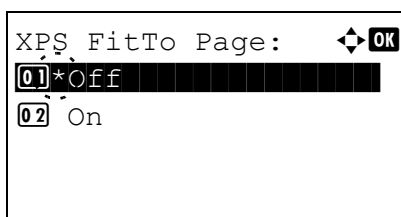

4 Press Δ or ∇ to select whether **XPS FitTo Page** mode is enabled.

5 Press **[OK]**. The **XPS FitTo Page** setting is set and the **Function** menu reappears.

Detail (Shows the details of the selected file)

Use this to view detailed information on the files and folders in the USB memory.

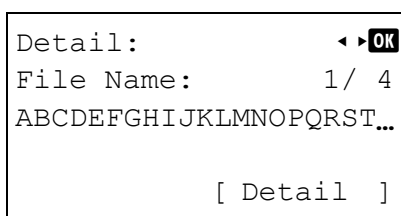

1 Use the procedure described in *Print File (Printing and checking the files in the USB memory)* on page 4-17 to display a list of the files or folders you want to check.

2 Press Δ or ∇ to select the folder or file you want to check.

3 Press [Detail] (**[Right Select]**). The **Detail** screen appears.

If you selected a file, there are 4 **Detail** screens. Press \triangleleft or \triangleright to move between the screens.

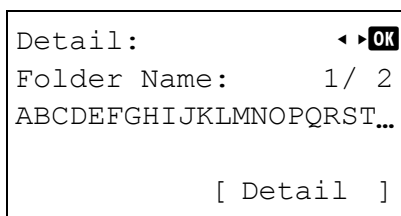

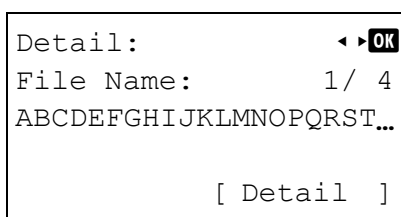

If you selected a folder, there are 2 **Detail** screens. Press \triangleleft or \triangleright to move between the screens.

Pressing **[OK]** while file or folder details are displayed returns you to the **Print File** menu.

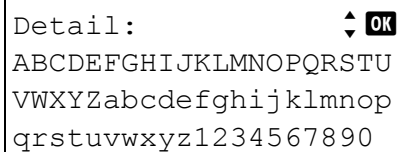

If the entire name shown as the **File Name** or **Folder Name** will not fit on one line, pressing [Detail] (**[Right Select]**) changes to a 3-line name display. If the name is 3 or more lines long, you can scroll up or down by pressing Δ or ∇ .

A screenshot of a printer's operation panel. The screen displays the word "Detail:" followed by a double-headed vertical arrow icon and a small "OK" button icon. Below this, three lines of text are shown: "ABCDEFGHIJKLMN OPQRSTU", "VWXYZabcdefghijklmnop", and "qrstuvwxyz1234567890".

Detail:  
ABCDEFGHIJKLMN OPQRSTU
VWXYZabcdefghijklmnop
qrstuvwxyz1234567890

Pressing **[OK]** twice while file or folder details are displayed returns you to the `Print File` menu.

Remove Memory (Removing the USB memory)

Allows you to remove a USB memory device.

- 1** In the `USB Memory` menu, press Δ or ∇ to select `Remove Memory`.
- 2** Press **[OK]**. The printer is now ready for the USB memory to be removed and the mode selection menu screen appears.

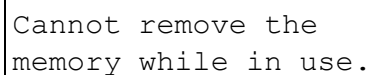
A screenshot of a printer's operation panel showing an error message. The text on the screen reads "Cannot remove the memory while in use."

Cannot remove the
memory while in use.

IMPORTANT If the screen on the left appears, the USB memory is still being used. Wait until the relevant job (e.g. printing from the USB memory) has ended and then repeat the `Remove Memory` procedure.

Counter (Viewing the counter value)

This only displays the total number of pages printed. You cannot change the displayed number.

Counter:		▲	OK
Total	17000	▼	
A4	2000		
B5	1000		

- 1 Press **[MENU]**.
- 2 Press Δ or ∇ to select Counter.
- 3 Press **[OK]**. The total number of pages to print and the number of pages per paper size are displayed.
Press Δ or ∇ to view the number of pages printed in other paper sizes.

Paper Settings

This sets the paper size and type for the MP tray and cassettes from which paper is supplied.

The options available in Paper Settings are as follows:

- MP Tray Set. (MP tray settings)...4-26
- Cassette (1 to 5) Set. (Settings for the cassettes)...4-28
- Bulk Feeder Set. (Settings for the optional bulk paper feeder)...4-33
- Media Type Set. (Paper type settings)...4-35
- Reset Type Adj. (Resets customized settings)...4-38

- 1 Press **[MENU]**.
- 2 Press Δ or ∇ to select Paper Settings.
- 3 Press **[OK]**. The Paper Settings menu appears showing a list of available options.

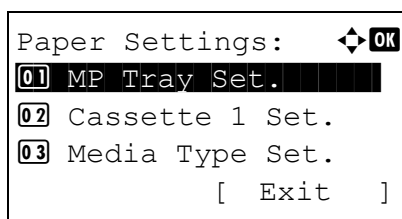

MP Tray Set. (MP tray settings)

To print correctly on paper supplied from the MP tray, use the procedure below to set the paper size and media type.

 **Note** Feeding the paper having a paper size which does not match the current paper size from the MP tray can cause paper jam.

The options available in MP Tray Set. menu are as follows:

- Paper Size (Paper size setting for the MP tray)...4-26
- Media Type (Paper type setting for the MP tray)...4-27

Paper Size (Paper size setting for the MP tray)

You can use this to set the paper size that can be supplied from the MP tray. The default setting is Letter size for the U.S. and Canada and A4 for other countries.

For more information about the paper sizes that you can feed from the MP tray, refer to *Paper on page A-13*.

- 1 In the Paper Settings menu, press Δ or ∇ to select MP Tray Set..
- 2 Press **[OK]**. The MP Tray Set. menu screen appears.
- 3 Press Δ or ∇ to select Paper Size.

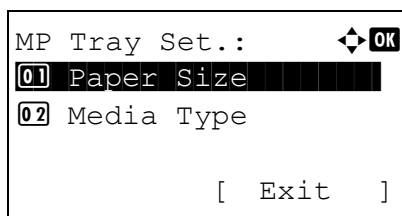

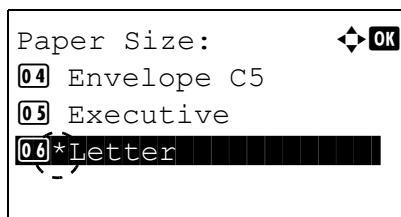

- 4 Press **[OK]**. The Paper Size screen appears listing the paper sizes that can be supplied from the MP tray.

The available paper sizes are as follows:

Envelope Monarch
 Envelope #10
 Envelope DL
 Envelope C5
 Executive
 Letter
 Legal
 A4
 B5
 A5
 A6
 B6
 Envelope #9
 Envelope #6
 ISO B5
 Custom
 Hagaki
 Oufuku Hagaki
 Oficio II
 216x340mm
 16K
 Statement
 Folio
 Youkei 2
 Youkei 4

- 5 Press Δ or ∇ to select the desired paper size.
- 6 Press **[OK]**. The paper size for the MP tray is set and the MP Tray Set. menu screen reappears.

Media Type (Paper type setting for the MP tray)

You can use this to set the paper type that can be supplied from the MP tray. The default setting is PLAIN.

For more information about paper types that you can feed from the MP tray, refer to *Paper* on page A-13.

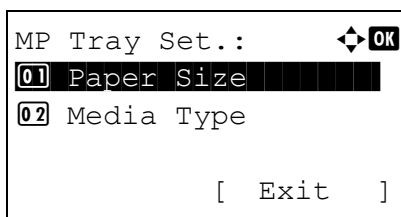

- 1 In the Paper Settings menu, press Δ or ∇ to select MP Tray Set..
- 2 Press **[OK]**. The MP Tray Set. menu screen appears.
- 3 Press Δ or ∇ to select Media Type.

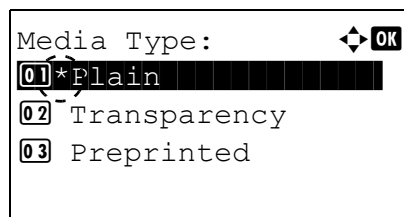

- 4** Press **[OK]**. The **Media Type** screen appears listing the media types that can be supplied from the MP tray.

The available media types are as follows:

Plain
 Transparency
 Preprinted
 Labels
 Bond
 Recycled
 Vellum
 Rough
 Letterhead
 Color
 Prepunched
 Envelope
 Cardstock
 Thick
 High Quality
 CUSTOM 1 to 8

- 5** Press Δ or ∇ to select the desired media type.

- 6** Press **[OK]**. The media type for the MP tray is set and the **MP Tray Set.** menu screen reappears.

Cassette (1 to 5) Set. (Settings for the cassettes)

To print correctly on paper supplied from the cassettes, use the procedure below to set the paper size and media type.

Set the cassette according to the paper size.

- Setting the standard paper size...4-28
- Setting the non-standard paper size...4-30

The options available in **Cassette (1 to 5) Set.** menu are as follows:

- Media Type (Setting the cassette paper type)...4-29
- Other Paper Size (Setting the Paper Size from the Operation Panel)...4-30
- Custom PaperSize (Setting a Custom Paper Size)...4-31

Setting the standard paper size

To set the standard sizes A5, A4, B5, Letter, Legal and A6 (paper cassette), the following operations are necessary.

- Setting the cassette paper size...4-28
- Media Type (Setting the cassette paper type)...4-29

Setting the cassette paper size

To set the standard sizes for the paper cassette, load the paper and turn the paper size dial so that the size of the paper you are going to use appears in the paper size window. To adjust the paper width guides and the paper length guide of the paper cassette, refer to *Loading Paper into the Cassette on page 2-22*.

If the PF-320 optional paper feeder is installed, use the same procedure to load paper into the paper feeder cassettes.

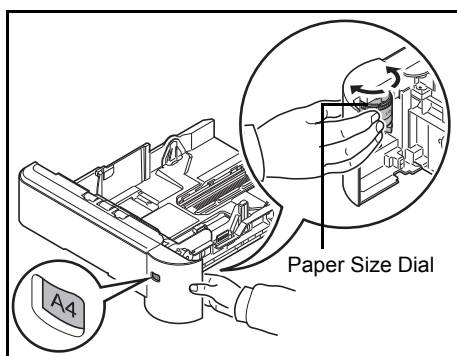

- 1 Pull the cassette out of the printer and set the paper size using the paper size dial.

- 2 Adjust the paper guides in the cassette to the size of the paper to be used for printing and load the paper into the cassette.

Media Type (Setting the cassette paper type)

By setting a paper type (plain, recycled, etc.) for the paper cassette, you can automatically select the paper in the paper cassette according to the paper type you command on the printer driver. The default setting is plain paper for all paper cassettes.

If the PF-320 optional paper feeder is installed, use the same procedure to setting the cassette paper type.

For more information about paper types that you can feed from the paper cassette, refer to *Paper Specifications* on page A-13.

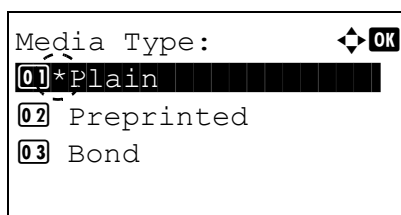
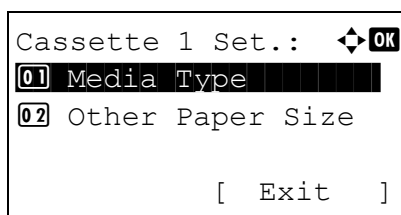

- 1 In the Paper Settings menu, press Δ or ∇ to select the cassette you want to set.

- 2 Press [OK]. The Cassette # Set. menu screen appears.
shows the number of the cassette installed in the printer (1 to 5).

- 3 Press Δ or ∇ to select Media Type.

- 4 Press [OK]. The Media Type screen appears listing the media types that can be used with the selected cassette.

The available Media Types are as follows:

Plain
Preprinted
Bond
Recycled
Rough
Letterhead
Color
Prepunched
Envelope (#1)
High Quality
CUSTOM 1 to 8

(#1): Only when optional paper feeder PF-320 is installed.

- 5 Press Δ or ∇ to select the desired media type.
- 6 Press [OK]. The media type for the cassette is set and the Cassette # Set. menu screen reappears.

Setting the non-standard paper size

To set the non-standard sizes (sizes other than A5, A4, B5, Letter, Legal and A6 (paper cassette)), the following operations are necessary.

- Selecting the Size Dial Setting...4-30
- Other Paper Size (Setting the Paper Size from the Operation Panel)...4-30
- Custom PaperSize (Setting a Custom Paper Size)...4-31
- Media Type (Setting the cassette paper type)...4-33

Selecting the Size Dial Setting

- 1 Pull the cassette out of the printer and set the paper size dial to **Other**. For details, refer to step 1 in *Setting the cassette paper size on page 4-28*.
- 2 Adjust the paper guides in the cassette to the size of the paper to be used for printing and load the paper into the cassette.

Other Paper Size (Setting the Paper Size from the Operation Panel)

Use the operation panel to set the size of paper loaded in the cassette on the printer.

 **Note** When `Custom` is selected, it is possible to enter the paper size. For details, refer to *Custom PaperSize (Setting a Custom Paper Size) on page 4-31*.

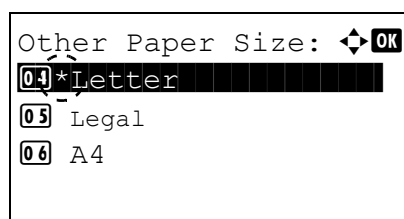
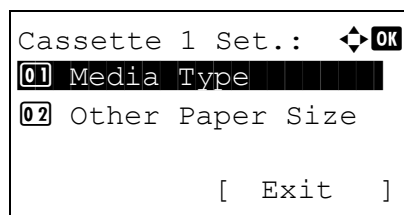

- 1 In the `Paper Settings` menu, press Δ or ∇ to select the paper cassette assigned to `Other` on the Size Dial.
- 2 Press **[OK]**. The `Cassette # Set.` menu screen appears.
shows the number of the cassette installed in the printer (1 to 5).

- 3 Press Δ or ∇ to select `Other Paper Size`.
- 4 Press **[OK]**. The `Other Paper Size` screen appears listing the paper sizes that can be used in the cassette.

The available paper sizes are as follows:

Envelope Monarch (#2)
Envelope #10 (#2)
Envelope DL (#3)
Envelope C5
Executive
Letter
Legal
A4
B5
A5
A6 (#1)
B6 (#3)
Envelope #9 (#2)
Envelope #6 (#2)
ISO B5

Custom
 Oufuku Hagaki (#3)
 Oficio II
 216x340mm
 16K
 Statement
 Folio
 Youkei 2 (#2)
 Youkei 4 (#2)

(#1): Cassette 1 for the FS-4100DN, FS-4200DN and FS-4300DN.

(#2): Only when optional paper feeder PF-320 is installed.

(#3): Cassette 1 except for the FS-2100D and FS-2100DN.

5 Press Δ or ∇ to select the desired paper size.



Note When *Custom* is selected, it is possible to enter the paper size. For details, refer to *Custom PaperSize (Setting a Custom Paper Size)* on page 4-31.

6 Press **[OK]**. The paper size for the cassette is set and the *Cassette # Set.* menu screen reappears.

If you selected *Custom* in step 4, use the procedure below to specify the paper length and width.

Custom PaperSize (Setting a Custom Paper Size)

In the procedure below, select the units to be used for entering the custom paper size and then enter the paper width and length. As shown in the figure, enter the Y and X values for the paper size, using the selected units.

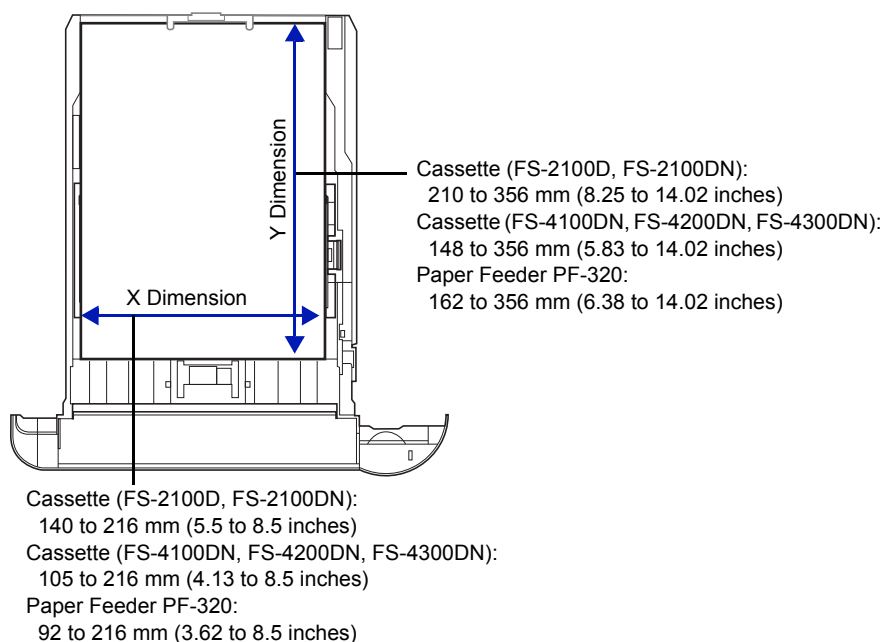

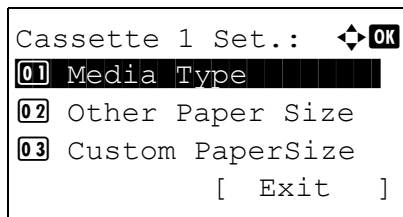

- 1 In the `Cassette # Set.` menu, press Δ or ∇ to select `Custom PaperSize`.
shows the number of the cassette installed in the printer (1 to 5).

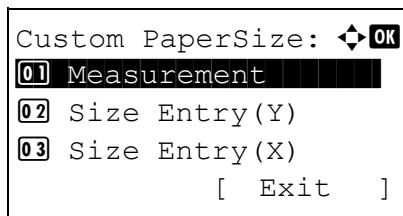

- 2 Press **[OK]**. The `Custom PaperSize` menu screen appears.

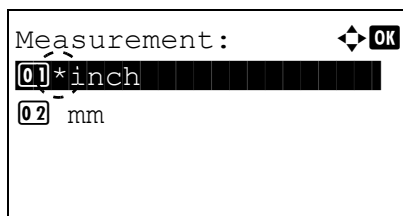

- 3 Press Δ or ∇ to select `Measurement`.
- 4 Press **[OK]**. The `Measurement` menu screen appears.

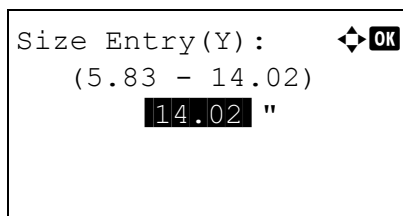

- 5 Press Δ or ∇ to select the paper size units and then press **[OK]**. The unit for entering the paper size is set and the `Custom PaperSize` menu screen reappears.
- 6 Press Δ or ∇ to select `Size Entry(Y)`.
- 7 Press **[OK]**. The `Size Entry(Y)` menu screen appears.

- 8 Use the numeric keys or press Δ or ∇ to enter the paper length. The range of paper lengths you can set for each cassette is as follows:

- Cassette (FS-2100D, FS-2100DN):
210 to 356 mm (8.25 to 14.02 inches)
- Cassette (FS-4100DN, FS-4200DN, FS-4300DN):
148 to 356 mm (5.83 to 14.02 inches)
- Paper Feeder PF-320:
162 to 356 mm (6.38 to 14.02 inches)

- 9 Press **[OK]**. The entered paper length is set and the `Custom PaperSize` menu screen reappears.

- 10 Press Δ or ∇ to select `Size Entry(X)`.

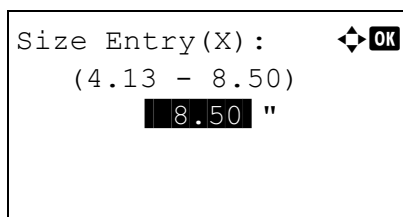

- 11 Press **[OK]**. The `Size Entry(X)` menu screen appears.

- 12** Use the numeric keys or Δ or ∇ to enter the paper width.

The range of paper widths you can set for each cassette is as follows:

- Cassette (FS-2100D, FS-2100DN):
140 to 216 mm (5.5 to 8.5 inches)
- Cassette (FS-4100DN, FS-4200DN, FS-4300DN):
105 to 216 mm (4.13 to 8.5 inches)
- Paper Feeder PF-320:
92 to 216 mm (3.62 to 8.5 inches)

- 13** Press **[OK]**. The entered paper width is set and the *Custom PaperSize* menu screen reappears.

- 14** Pressing **[Exit]** (**[Right Select]**) returns to the Ready to print screen.

Media Type (Setting the cassette paper type)

To set the paper type for the paper cassette, refer to *Media Type (Setting the cassette paper type)* on page 4-29.

Bulk Feeder Set. (Settings for the optional bulk paper feeder)

To print correctly on paper supplied from the optional bulk paper feeder, use the procedure below to set the paper size and media type.

 **Note** Bulk Feeder Set. is displayed only when the optional bulk paper feeder is installed on the printer.

The options available in Bulk Feeder Set. menu are as follows:

- Paper Size (Paper size setting for the optional bulk paper feeder)...4-33
- Media Type (Paper type setting for the optional bulk paper feeder)...4-34

Paper Size (Paper size setting for the optional bulk paper feeder)

You can use this to set the paper size that can be supplied from the optional bulk paper feeder.

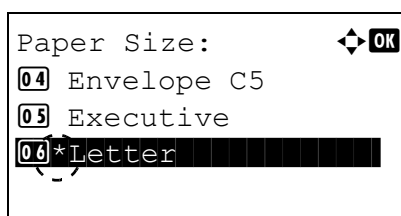
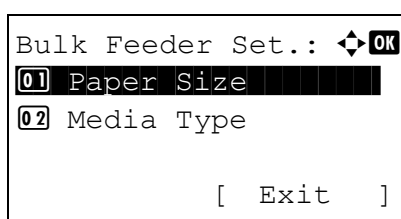

- 1** In the *Paper Settings* menu, press Δ or ∇ to select *Bulk Feeder Set.*

- 2** Press **[OK]**. The *Bulk Feeder Set.* menu screen appears.

- 3** Press Δ or ∇ to select *Paper Size*.

- 4** Press **[OK]**. The *Paper Size* screen appears listing the paper sizes that can be supplied from the bulk paper feeder.

The available paper sizes are as follows:

Envelope Monarch
Envelope #10
Envelope DL
Envelope C5
Executive
Letter
A4
B5

A5
 A6
 B6
 Envelope #9
 Envelope #6
 ISO B5
 Custom
 Hagaki
 Oufuku Hagaki
 16K
 Statement
 Youkei 2
 Youkei 4

- 5** Press Δ or ∇ to select the desired paper size.
- 6** Press **[OK]**. The paper size for the bulk paper feeder is set and the Bulk Feeder Set. menu screen reappears.

Media Type (Paper type setting for the optional bulk paper feeder)

You can use this to set the paper type that can be supplied from the optional bulk paper feeder.

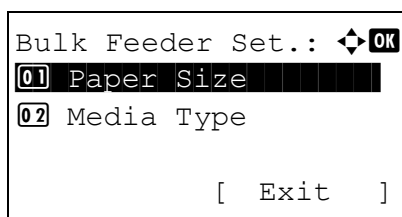

- 1** In the Paper Settings menu, press Δ or ∇ to select Bulk Feeder Set..
- 2** Press **[OK]**. The Bulk Feeder Set. menu screen appears.

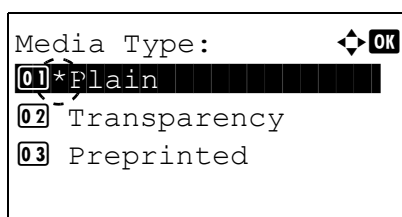

- 3** Press Δ or ∇ to select Media Type.
- 4** Press **[OK]**. The Media Type screen appears listing the media types that can be supplied from the bulk paper feeder.

The available media types are as follows:

Plain
 Transparency
 Preprinted
 Labels
 Bond
 Recycled
 Vellum
 Rough
 Letterhead
 Color
 Prepunched
 Envelope
 Cardstock
 Thick
 High Quality
 CUSTOM 1 to 8

- 5 Press Δ or ∇ to select the desired media type.
- 6 Press **[OK]**. The media type for the bulk paper feeder is set and the Bulk Feeder Set. menu screen reappears.

Media Type Set. (Paper type settings)

You can set the paper thickness by selecting a paper weight. This allows you to set the paper thickness for each of the media types that can be used on the printer. And for custom paper registered in the printer (up to 8), you can specify paper thickness and whether duplex printing is permitted. (For the procedure for registering custom paper sizes, refer to *Custom PaperSize (Setting a Custom Paper Size)* on page 4-31.)

For normal settings, refer to *Setting the Paper Thickness* on page 4-35. For custom paper settings, refer to *Custom Paper Settings* on page 4-36.

The options available in Media Type Set. menu are as follows:

- Setting the Paper Thickness...4-35
- Custom Paper Settings...4-36

Setting the Paper Thickness

You can set the paper thickness by selecting a paper weight.

The available paper weights are as follows:

- Extra Heavy
- Heavy 3
- Heavy 2
- Heavy 1
- Normal 3
- Normal 2
- Normal 1
- Light

The default setting is Normal 2 for plain paper. When using any paper other than plain paper, you should change the paper weight referring to the table below to achieve the best possible print quality for each paper.

 **Note** Depending on the type of paper, the toner may not adhere to the paper properly. To solve this problem, select the half speed mode from the printer driver. For more information, refer to *Half Speed Mode (Printer Driver Settings)* on page 3-6.

Media Type	Paper Weight	Media Type	Paper Weight
Plain	Normal 2	Letterhead	Normal 3
Transparency	Extra Heavy	Color	Normal 3
Preprinted	Normal 2	Prepunched	Normal 2
Labels	Heavy 1	Envelope	Heavy 3
Bond	Normal 3	Cardstock	Heavy 3
Recycled	Normal 2	Thick	Heavy 3
Vellum	Light	HighQuality	Normal 2
Rough	Normal 3	CUSTOM 1 to 8	Normal 2

Use the procedure below to set the paper weight.

(For the procedure for setting weights for custom paper (CUSTOM 1 to 8), refer to *Custom Paper Settings* on page 4-36.)

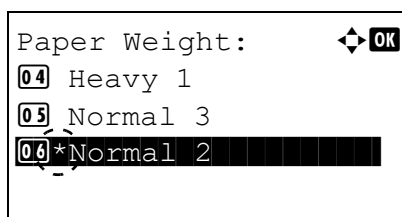
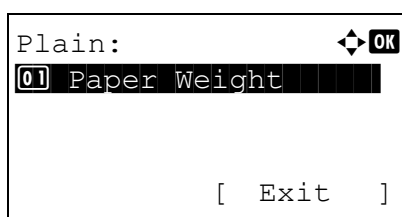
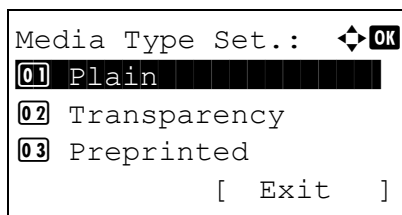

- 1** In the Paper Settings menu, press Δ or ∇ to select Media Type Set..
- 2** Press **[OK]**. The Media Type Set. screen appears listing the media types that can used with the printer.
- 3** Press Δ or ∇ to select the media type for which you want to set the paper weight.
- 4** Press **[OK]**. A menu for the selected media is displayed.
- 5** Press Δ or ∇ to select Paper Weight.
- 6** Press **[OK]**. The Paper Weight screen appears listing the paper weights that can used with the printer.
- 7** Press Δ or ∇ to select the desired paper weight.
- 8** Press **[OK]**. The paper weight is set and the Media Type Set. screen reappears.

Custom Paper Settings

This setting specifies the paper weight of the selected custom paper, whether duplex printing is permitted and the registration of the name to be displayed.

Use the procedure below to set the custom paper weight.

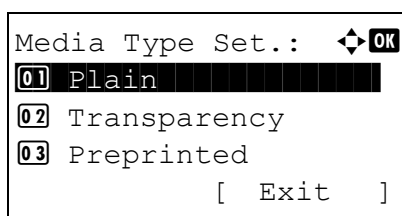

- 1** In the Paper Settings menu, press Δ or ∇ to select Media Type Set..
- 2** Press **[OK]**. The Media Type Set. screen appears listing the media types that can used with the printer.
- 3** Press Δ or ∇ to select the custom paper (CUSTOM 1 to 8) for which you want to set the paper weight.

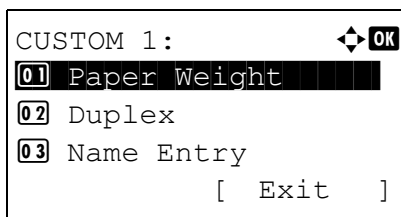

4 Press **[OK]**. A menu for the selected media is displayed.

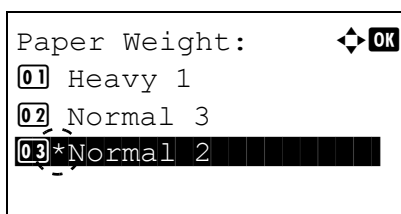

5 Press Δ or ∇ to select Paper Weight.

6 Press **[OK]**. The Paper Weight screen appears listing the paper weights that can used with the printer.

7 Press Δ or ∇ to select the desired paper weight.

8 Press **[OK]**. The paper weight is set and the Media Type Set. screen reappears.

Use the procedure below to specify whether duplex printing is permitted with custom paper.

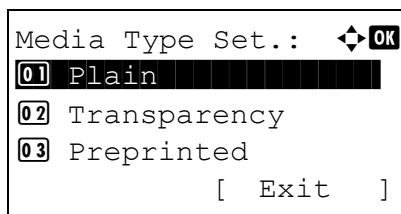

1 In the Paper Settings menu, press Δ or ∇ to select Media Type Set..

2 Press **[OK]**. The Media Type Set. screen appears listing the media types that can used with the printer.

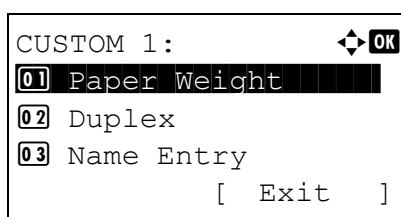

3 Press Δ or ∇ to select the custom paper (CUSTOM 1 to 8) for which you want to set the duplex printing permission.

4 Press **[OK]**. A menu for the selected media is displayed.

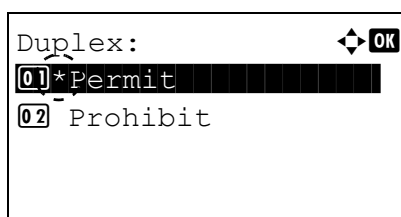

5 Press Δ or ∇ to select Duplex.

6 Press **[OK]**. The Duplex screen appears listing the paper weights that can used with the printer.

7 Press Δ or ∇ to specify whether duplex printing is permitted.

8 Press **[OK]**. The duplex printing permission is set and the Media Type Set. screen reappears.

Use the procedure below to register the name to be displayed for the custom paper.

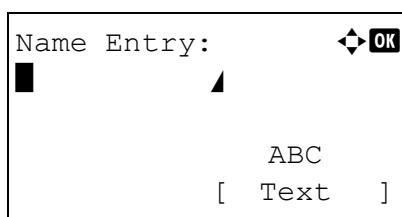
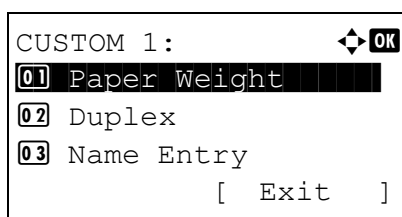
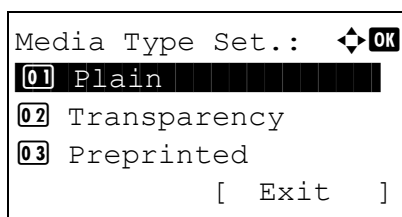

- 1 In the Paper Settings menu, press Δ or ∇ to select Media Type Set..
- 2 Press [OK]. The Media Type Set. screen appears listing the media types that can be used with the printer.
- 3 Press Δ or ∇ to select the custom paper (CUSTOM 1 to 8) for which you want to register a name to display.
- 4 Press [OK]. A menu for the selected media is displayed.
- 5 Press Δ or ∇ to select Name Entry.
- 6 Press [OK]. The Name Entry screen appears.
- 7 Use the numeric keys to enter the name to display for the custom paper.

 **Note** Up to 16 characters can be entered. For details on entering characters, refer to *Character Entry Method* on page A-2.
- 8 Press [OK]. Register the name to display and the renamed custom paper screen reappears.

Reset Type Adj. (Resets customized settings)

This resets all the settings specified in *Media Type Set. (Paper type settings)* on page 4-35.

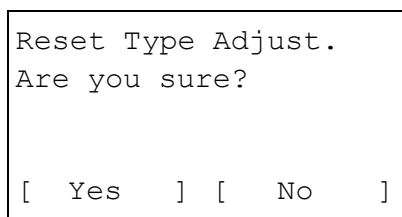

- 1 In the Paper Settings menu, press Δ or ∇ to select Reset Type Adj..
- 2 Press [OK]. A confirmation screen appears.
- 3 Press [Yes] ([Left Select]). The message Completed. appears and the Paper Settings menu reappears. Pressing [No] ([Right Select]) returns to the Paper Settings menu without resetting the customized settings.

Print Settings

These settings specify the following printing parameters: paper feed source, paper feed mode, duplex printing, override A4/LTR, emulation mode, print quality, and setting pagination.

The options available in Print Settings are as follows:

- Paper Source (Selecting the paper feed source)...4-39
- MP Tray Priority (the settings for priority paper feed from the MP tray)...4-39
- Paper Feed Mode (Setting the paper feed source)...4-40
- Duplex (Setting the duplex printing)...4-41
- Paper Output (Selecting the output stack)...4-42
- Override A4/LTR (Overriding difference between A4 and Letter)...4-42
- Emulation (Setting the emulation)...4-43
- Font (Selecting the default font)...4-45
- Code Set (Setting the code set)...4-47
- Print Quality (Setting print quality)...4-48
- Page Setting (Setting pagination)...4-50
- User Name (The User Name display settings)...4-53
- Job Name (The Job Name display settings)...4-53

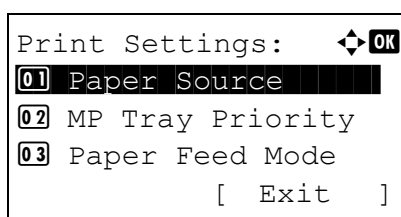

- 1 Press **[Menu]**.
- 2 Press Δ or ∇ to select `Print Settings`.

- 3 Press **[OK]**. The `Print Settings` menu appears showing a list of available options.

Paper Source (Selecting the paper feed source)

You can select the paper source from which the printer feeds paper as the default. If an optional paper feeder(s) is installed, it can also be set the default paper source.

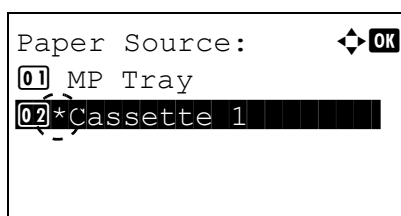

- 1 In the `Print Settings` menu, press Δ or ∇ to select `Paper Source`.
- 2 Press **[OK]**. The `Paper Source` screen appears showing a list of the available paper sources.

The available paper sources are as follows:

MP Tray

Cassette 1 (printer's standard paper cassette)

Cassette 2 to 5 (optional paper feeders (only installed paper feeders are shown))

- 3 Press Δ or ∇ to select the desired paper source.
- 4 Press **[OK]**. The paper source is set and the `Print Settings` menu reappears.

MP Tray Priority (the settings for priority paper feed from the MP tray)

If paper is set in the MP Tray then it is possible for priority to be given to that MP tray in the paper feed.

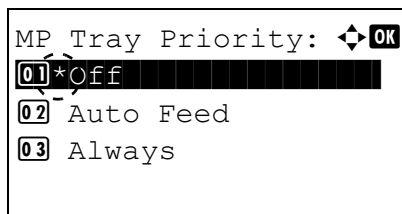

- 1** In the `Print Settings` menu, press Δ or ∇ to select `MP Tray Priority`.
- 2** Press **[OK]**. The `MP Tray Priority` screen appears showing the available MP tray priority mode options.
 - `Off` (The printer driver settings are followed.)
 - `Auto Feed` (If `Auto` is selected in the printer driver and there is paper in the MP tray then the paper feed will be from the MP tray.)
 - `Always` (If there is paper in the MP tray then the paper feed will be from the MP tray regardless of what is set in the printer driver.)
- 3** Press Δ or ∇ to select the desired MP tray priority mode.
- 4** Press **[OK]**. The MP tray priority mode is set and the `Print Settings` menu reappears.

Paper Feed Mode (Setting the paper feed source)

This mode specifies how the paper should be fed once the paper feed source and paper type have been chosen. If `Auto` is selected, the printer searches for a paper feed source that matches the paper size and type, and paper is then delivered from that source. If `Fixed` is selected and there is no matching paper feed source, handling proceeds as specified by `Paper Mismatch for Error Handling`. For details on paper feeding when `Fixed` is selected, refer to *Paper Mismatch (Detection settings for paper size/type errors when the paper source is fixed)* on page 4-85. The default setting is `Auto`. To change the settings, follow the steps described below.

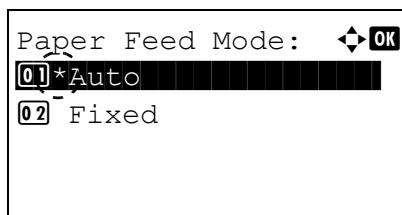

- 1** In the `Print Settings` menu, press Δ or ∇ to select `Paper Feed Mode`.
- 2** Press **[OK]**. The `Paper Feed Mode` screen appears showing the available paper feed options.
- 3** Press Δ or ∇ to select the desired paper feed mode.
- 4** Press **[OK]**. The paper feed mode is set and the `Print Settings` menu reappears.

When the Paper Runs Out During Printing

When `Paper Feed Mode` is set to `Fixed`, if the paper in the cassette runs out during printing, `Load paper in cassette 1.` is displayed and the printer stands by. In this event, either replenish the paper in the empty cassette or use the procedure below to print from another paper source.

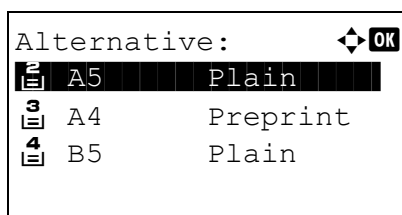

- 1** While `Load paper in cassette 1.` is displayed, press **[Alt.]** (**[Left Select]**). The `Alternative` menu screen appears.
- 2** Press Δ or ∇ to select the desired paper feed source and paper size.
- 3** Press **[OK]**. Printing continues.

Duplex (Setting the duplex printing)

Using the duplexer, you can automatically print on both sides of the paper.

Duplex printing is available for the following paper (media) types:

- Plain
- Preprinted
- Bond
- Recycled
- Rough
- Letterhead
- Color
- Prepunched
- High Quality
- Custom 1 to 8

 **Note** Duplex printing can be also performed from the MP tray. If the paper to be fed from the MP tray does not match the paper size and paper type of the current paper feed source cassette, a paper jam may occur.

When `Custom` is specified, duplex printing can be set. For details, refer to *Custom Paper Settings on page 4-36*.

Binding Modes

Binding refers to the manner in which printed pages of paper are joined together (by gluing, stitching, etc.) in book form. The two possible types of binding are: Bind Long Edge, in which pages are joined together along their long edge; and Bind Short Edge, in which they are joined together along their short edge. In selecting a binding type, you must also consider the orientation of the printed page. You can use Bind Long Edge or Bind Short Edge with either landscape or portrait printing.

Depending on the binding type and print orientation, the duplexer provides four types of binding. These are: (1) portrait, Bind Long Edge, (2) portrait, Bind Short Edge, (3) landscape, Bind Long Edge, and (4) landscape, Bind Short Edge. The figure below shows these binding methods.

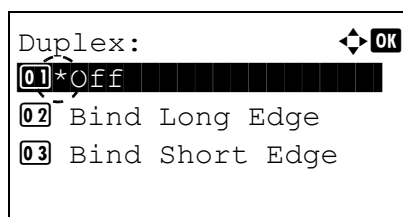
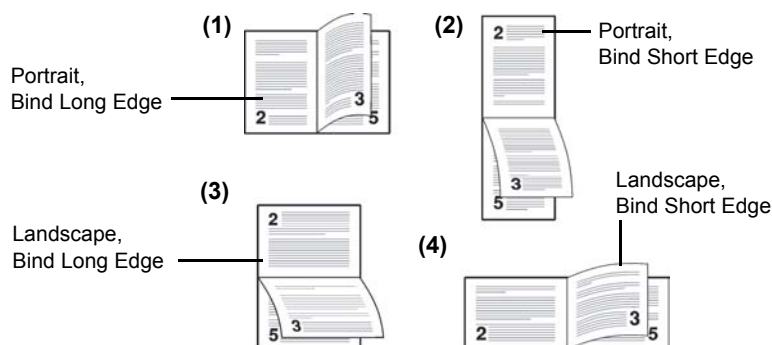

- 1** In the `Print Settings` menu, press Δ or ∇ to select `Duplex`.
- 2** Press **[OK]**. The `Duplex` screen appears showing the list of available duplex printing modes.
- 3** Press Δ or ∇ to select the desired duplex printing mode.
The message display toggles through the following:
`Off` (default)

Bind Long Edge

Bind Short Edge

Selecting *Off* disables duplex printing.

- 4 Press **[OK]**. The duplex printing mode is set and the *Print Settings* menu reappears.

Paper Output (Selecting the output stack)

The Paper Output menu on the operation panel allows you to select either the face-down tray or the faceup tray option for the output stack.



Note This menu can be used for FS-4100DN, FS-4200DN and FS-4300DN.

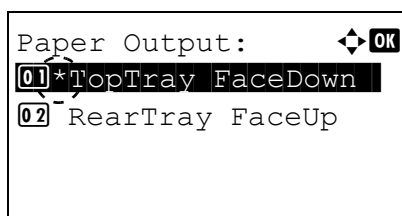

- 1 In the *Print Settings* menu, press Δ or ∇ to select *Paper Output*.
- 2 Press **[OK]**. The *Paper Output* screen appears.
- 3 Press Δ or ∇ to select *output stack - TopTray FaceDown* or *Rear Tray FaceUp*.
- 4 Press **[OK]**. The output stack is set and the *Print Settings* menu reappears.

Override A4/LTR (Overriding difference between A4 and Letter)

When the *Override A4/LTR* is turned *On* using the operation panel, the printer ignores the difference between A4 and Letter paper sizes. Printing is performed without an error message even if the actual paper size in the current cassette differs from the paper size formatting the job.

By default, this feature is *On*.

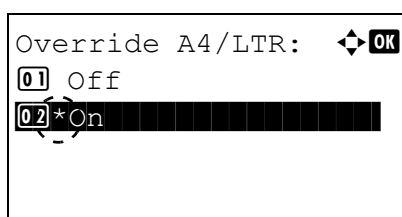

- 1 In the *Print Settings* menu, press Δ or ∇ to select *Override A4/LTR*.
- 2 Press **[OK]**. The *Override A4/LTR* screen appears.
- 3 Press Δ or ∇ to select *Off* or *On*.
- 4 Press **[OK]**. The *Print Settings* menu reappears.

Emulation (Setting the emulation)

You can change the emulation mode. Use the procedure below to select the mode.



Note To print the PDF file using FTP printing, set emulation to `KPDL`.

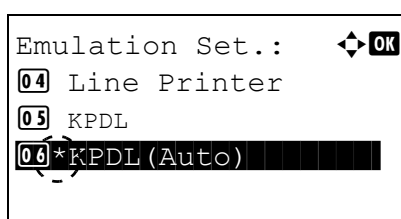
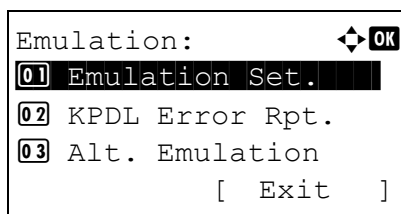

- 1 In the `Print Settings` menu, press Δ or ∇ to select `Emulation`.
- 2 Press **[OK]**. The `Emulation` menu screen appears.

- 3 Press Δ or ∇ to select `Emulation Set..`
- 4 Press **[OK]**. The `Emulation Set.` screen appears showing a list of the available emulations. The defaults differ depending on the delivery destination.

The available emulations are as follows:

PCL6
 IBM Proprinter
 EPSON LQ-850
 Line Printer
 KPDL
 KPDL (Auto)

- 5 Press Δ or ∇ to select the desired emulation.
- 6 Press **[OK]**. The emulation is set and the `Emulation` menu reappears.

KPDL Error Rpt. (Printing KPDL errors)

The printer can print error descriptions when printing error occurs during KPDL emulation. The default setting differs depending on the countries or regions.

IMPORTANT This setting only appears when `KPDL` or `KPDL (Auto)` is selected for the emulation.

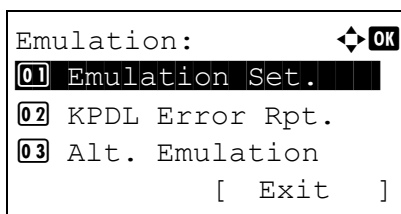

- 1 In the `Print Settings` menu, press Δ or ∇ to select `Emulation`.
- 2 Press **[OK]**. The `Emulation` menu screen appears.

- 3 Press Δ or ∇ to select `KPDL Error Rpt..`

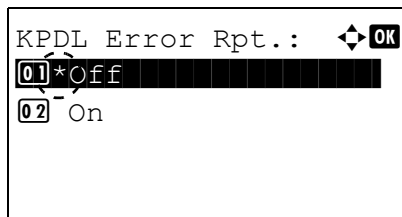

- 4 Press **[OK]**. The KPD L Error Rpt. screen appears.
- 5 Press Δ or ∇ to select whether error reports are printed.
- 6 Press **[OK]**. The error report print setting is set and the Emulation menu reappears.

Alt. Emulation (Alternative Emulation for KPD L Emulation)

The KPD L (AUTO) emulation enables the printer to automatically change the emulation mode according to the data received when printing.

IMPORTANT This setting only appears when KPD L (Auto) is selected for the emulation.

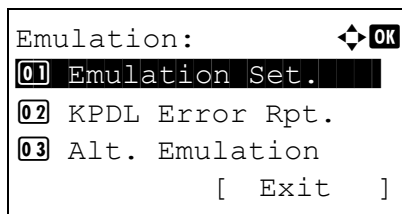

- 1 In the Print Settings menu, press Δ or ∇ to select Emulation.
- 2 Press **[OK]**. The Emulation menu screen appears.

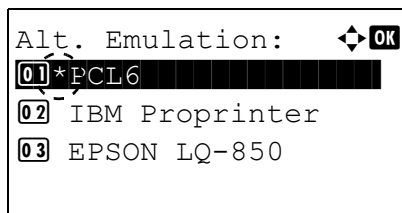

- 3 Press Δ or ∇ to select Alt. Emulation.
- 4 Press **[OK]**. The Alt. Emulation screen appears showing a list of the available alternative emulations.
The available alternative emulations are as follows:
PCL6
IBM Proprinter
EPSON LQ-850
Line Printer
- 5 Press Δ or ∇ to select the desired alternative emulation.
- 6 Press **[OK]**. The alternative emulation is set and the Emulation menu reappears.

Font (Selecting the default font)

You can select the default font. The default font can be one of the internal fonts or a font that is downloaded to the printer memory or stored on SD/SDHC memory card, or SSD.

In this menu, you can also set the type and pitch for Courier and Letter Gothic.

The options available in Font menu are as follows:

- Selecting Regular or Dark Courier/Letter Gothic...4-46
- Changing the Default Font Size...4-46
- Character Pitch...4-47

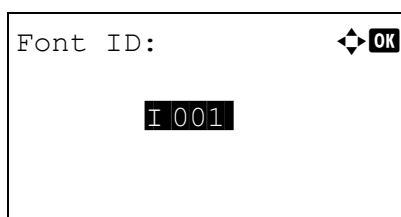
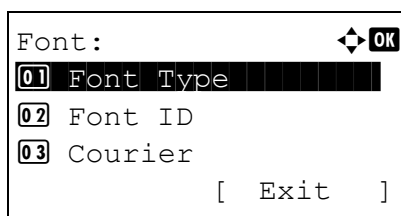
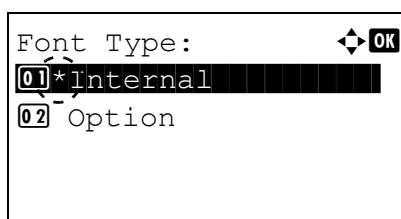
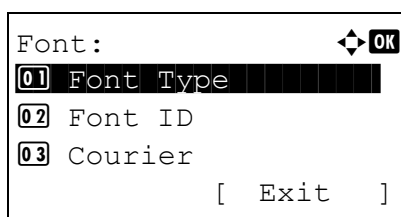

- 1 In the `Print Settings` menu, press Δ or ∇ to select `Font`.
- 2 Press **[OK]**. The `Font` menu screen appears.

- 3 Press Δ or ∇ to select `Font Type`.
- 4 Press **[OK]**. The `Font Type` screen appears.

- 5 To select a font built-in the printer, press Δ or ∇ to select `Internal`.
- 6 Press **[OK]**. Select the font type and the `Font` menu reappears.

- 7 Press Δ or ∇ to select `Font ID`.
- 8 Press **[OK]**. The `Font ID` entry screen appears.

- 9 Press Δ or ∇ to select the number of the desired font.



Note It is possible to check the numbers of the built-in fonts by outputting a Font List. For details, refer to *Font List (Printing a list of the printer's fonts)* on page 4-14.

For details on entering characters, refer to *Character Entry Method* on page A-2.

To select optional fonts other than those built-in, select `Option` in step 5. You can perform this operation only when optional fonts are installed in the printer.

The letter before the number indicates the location of the font, as shown below.

I: Internal font

S: Soft (downloaded) font

M: Fonts in optional SD/SDHC card

H: Fonts in RAM disk or optional SSD

10 Press **[OK]**. The default font is set and the `Font` menu reappears.

Selecting Regular or Dark Courier/Letter Gothic

Courier or Letter Gothic font thickness can be selected as `Regular` or `Dark`. In the procedure below, it is assumed that `Courier` is selected. The procedure is the same for `Letter Gothic`.

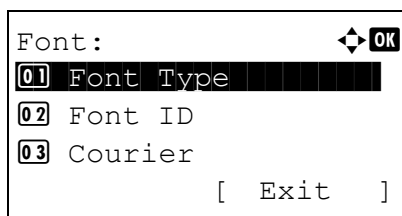

1 In the `Print Settings` menu, press Δ or ∇ to select `Font`.

2 Press **[OK]**. The `Font` menu screen appears.

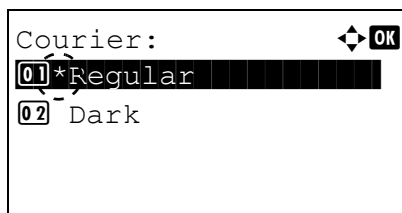

3 Press Δ or ∇ to select `Courier`. If you are selecting the thickness of the `Letter Gothic` font, choose `Letter Gothic` here instead.

4 Press **[OK]**. The `Courier` screen appears.

5 Press Δ or ∇ to select `Regular` or `Dark`.

6 Press **[OK]**. The font thickness is set and the `Font` menu reappears.

Changing the Default Font Size

You can change the size of the default font. If you selected a proportional font, the character size can be changed.

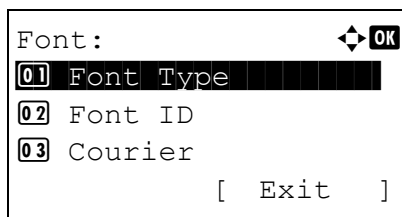

1 In the `Print Settings` menu, press Δ or ∇ to select `Font`.

2 Press **[OK]**. The `Font` menu screen appears.

3 Press Δ or ∇ to select `Size`.

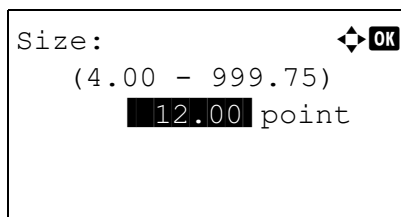

4 Press **[OK]**. The `Size` entry screen appears.

5 Press Δ or ∇ to enter the font size.



Note The font size can be set between 4.00 and 999.75 points, in 0.25-point increments.

6 Press **[OK]**. The font size is set and the `Font` menu reappears.

Character Pitch

You can set the character pitch for fixed fonts.

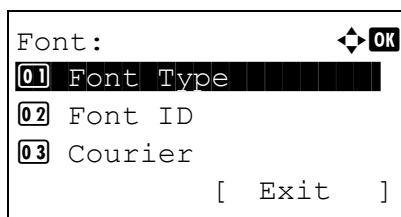

1 In the `Print Settings` menu, press Δ or ∇ to select `Font`.

2 Press **[OK]**. The `Font` menu screen appears.

3 Press Δ or ∇ to select `Pitch`.

4 Press **[OK]**. The `Pitch` entry screen appears.

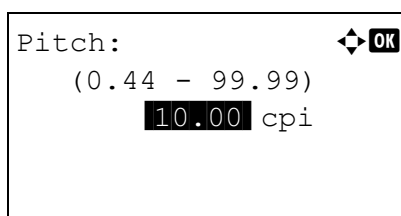

5 Use the numeric keys or press Δ or ∇ to enter the character pitch.



Note The character pitch can be set between 0.44 and 99.99 characters per inch, in 0.01 character-per-inch increments.

6 Press **[OK]**. The character pitch is set and the `Font` menu reappears.

Code Set (Setting the code set)

You can change the character code set. Available character code sets vary depending on the current font. (The default is IBM PC-8.)

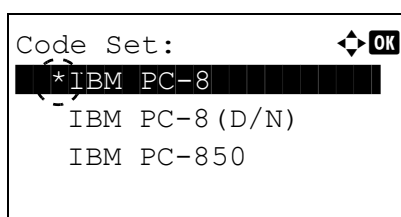

1 In the `Print Settings` menu, press Δ or ∇ to select `Code Set`.

2 Press **[OK]**. The `Code Set` screen appears listing the available character code sets.

- 3 Press Δ or ∇ to select the desired character code set.
- 4 Press **[OK]**. The character code set is set and the `Print Settings` menu reappears.

Print Quality (Setting print quality)

In `Print Quality` menus, you can set the KIR mode, EcoPrint mode, and other settings.

The options available in `Print Quality` are as follows:

- KIR (Selecting the KIR mode)...4-48
- EcoPrint (Selecting the EcoPrint mode)...4-48
- Print Resolution (Selecting the Print Resolution)...4-49
- Print Density (Selecting the Print Density)...4-49

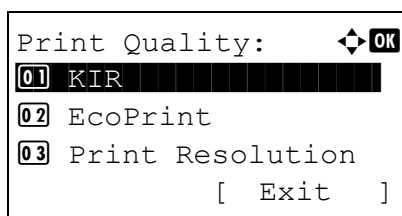

- 1 In the `Print Settings` menu, press Δ or ∇ to select `Print Quality`.
- 2 Press **[OK]**. The `Print Quality` menu screen appears.

KIR (Selecting the KIR mode)

This printer incorporates the KIR (Kyocera Image Refinement) smoothing function. KIR uses the software to enhance resolution, resulting in high quality printing at resolution of 600 dpi and 300 dpi. The default is `On`. KIR has no effect on the printing speed.

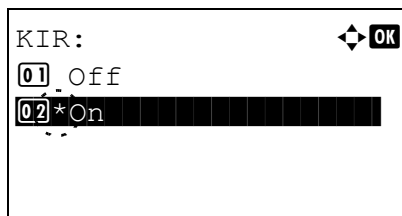

- 1 In the `Print Quality` menu, press Δ or ∇ to select `KIR`.
- 2 Press **[OK]**. The `KIR` screen appears.

- 3 Press Δ or ∇ to select whether the KIR mode is enabled.
- 4 Press **[OK]**. The KIR mode is set and the `Print Quality` menu screen reappears.

EcoPrint (Selecting the EcoPrint mode)

By enabling EcoPrint mode, you can minimize the amount of toner used during printing. Because images printed in this mode may be slightly coarser than those printed in standard resolution, you should use EcoPrint for test prints or other situations where high-quality prints are not required. EcoPrint has no effect on the printing speed.

Use the procedure below to select EcoPrint mode. The default setting is `Off`.

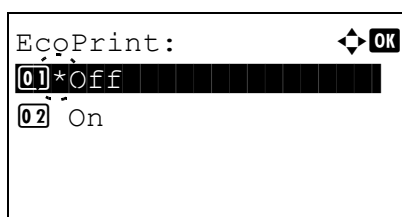

- 1 In the `Print Quality` menu, press Δ or ∇ to select `EcoPrint`.
- 2 Press **[OK]**. The `EcoPrint` screen appears.

- 3 Press Δ or ∇ to select whether the EcoPrint mode is enabled.
- 4 Press **[OK]**. The EcoPrint mode is set and the `Print Quality` menu screen reappears.

Print Resolution (Selecting the Print Resolution)

You can set the default print resolution in four ways: 300dpi, 600dpi, Fast1200 and Fine1200. The clarity of printed characters and graphics becomes sharper in this order.

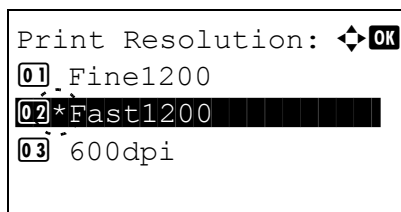

- 1 In the `Print Quality` menu, press Δ or ∇ to select `Print Resolution`.
- 2 Press **[OK]**. The `Print Resolution` screen appears.
- 3 Press Δ or ∇ to select the `Print Resolution`.
- 4 Press **[OK]**. The `Print Resolution` is set and the `Print Quality` menu screen reappears.

Print Density (Selecting the Print Density)

The print density can be adjusted in five steps: from 1 lighter to 5 darker. The default setting is 3.

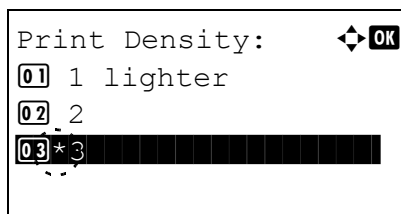

- 1 In the `Print Quality` menu, press Δ or ∇ to select `Print Density`.
- 2 Press **[OK]**. The `Print Density` screen appears.
- 3 Press Δ or ∇ to select the print density from five steps from 1 lighter to 5 darker
- 4 Press **[OK]**. The print density is set and the `Print Quality` menu screen reappears.

Page Setting (Setting pagination)

You can use the Page Setting menu to set the number of copies, the page orientation and other pagination settings.

The options available in Page Setting are as follows:

- Copies (Number of copies)...4-50
- Orientation (Print orientation)...4-50
- LF Action (Linefeed)...4-51
- CR Action (Carriage-Return)...4-51
- Wide A4 (Wide A4 pitch)...4-51
- XPS FitTo Page (Adjusting the XPS file print out size)...4-52
- TIFF/JPEG Size (Adjusting the TIFF/JPEG file print out size)...4-52

- 1** In the Print Settings menu, press Δ or ∇ to select Page Setting.
- 2** Press **[OK]**. The Page Setting menu screen appears.

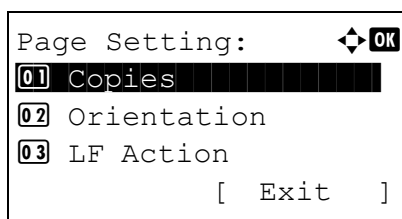

Copies (Number of copies)

You can set the number of copies of each page to be printed.

- 1** In the Page Setting menu, press Δ or ∇ to select Copies.
- 2** Press **[OK]**. The Copies screen appears.

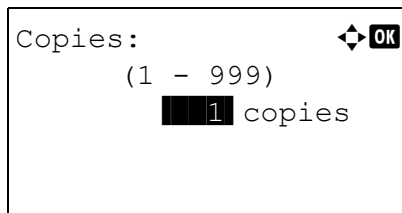

- 3** Use the numeric keys or press Δ or ∇ to set the number of copies.
- 4** Press **[OK]**. The setting is stored and the Page Setting menu reappears.

Orientation (Print orientation)

You can select portrait (upright) or landscape (sideways) page orientation.

Portrait Orientation

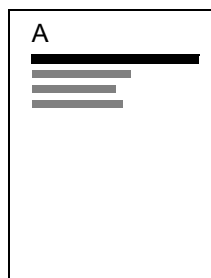

Landscape Orientation



- 1** In the Page Setting menu, press Δ or ∇ to select Orientation.

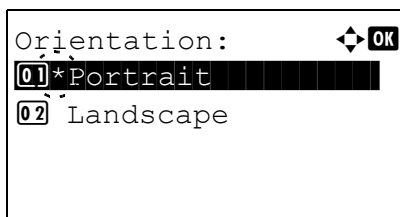

- 2** Press **[OK]**. The Orientation screen appears.
- 3** Press Δ or ∇ to select the desired Orientation.
- 4** Press **[OK]**. The orientation is set and the Page Setting menu reappears.

LF Action (Linefeed)

This procedure instructs the printer what to do when it receives a linefeed code (0AH).

- LF Only: Linefeed is performed (Default).
- LF and CR: A linefeed and carriage return are performed.
- Ignore LF: The linefeed is ignored.

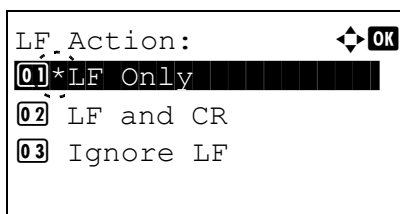

- 1** In the Page Setting menu, press Δ or ∇ to select LF Action.
- 2** Press **[OK]**. The LF Action screen appears.
- 3** Press Δ or ∇ to select the desired action.
- 4** Press **[OK]**. The action is set and the Page Setting menu reappears.

CR Action (Carriage-Return)

This procedure instructs the printer what to do when it receives a carriage return code (0DH).

- CR Only: A carriage-return is performed (Default).
- LF and CR: A linefeed and carriage return are performed.
- Ignore CR: The carriage-return is ignored.

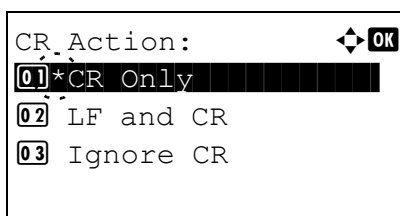

- 1** In the Page Setting menu, press Δ or ∇ to select CR Action.
- 2** Press **[OK]**. The CR Action screen appears.
- 3** Press Δ or ∇ to select the desired action.
- 4** Press **[OK]**. The action is set and the Page Setting menu reappears.

Wide A4 (Wide A4 pitch)

Turn this to On to increase the maximum number of characters that can be printed in a line for an A4 page (78 characters at 10 pitches) and Letter size page (80 characters at 10 pitches). This setting is only effective in PCL 6 emulation.

- 1** In the Page Setting menu, press Δ or ∇ to select Wide A4.

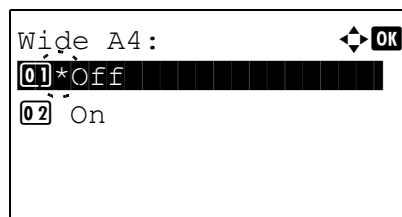

2 Press **[OK]**. The Wide A4 screen appears.

3 Press Δ or ∇ to select whether Wide A4 mode is enabled.

4 Press **[OK]**. The wide mode setting is set and the Page Setting menu reappears.

XPS FitTo Page (Adjusting the XPS file print out size)

Select On in this setting to enlarge or reduce XPS files to fit the printable area during printing.

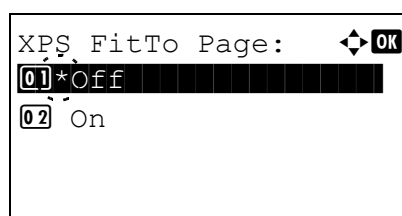

1 In the Page Setting menu, press Δ or ∇ to select XPS FitTo Page.

2 Press **[OK]**. The XPS FitTo Page screen appears.

3 Press Δ or ∇ to select whether XPS FitTo Page mode is enabled.

4 Press **[OK]**. The XPS FitTo Page setting is set and the Page Setting menu reappears.

TIFF/JPEG Size (Adjusting the TIFF/JPEG file print out size)

Use this setting to select the printing method used when TIFF or JPEG files are printed directly.

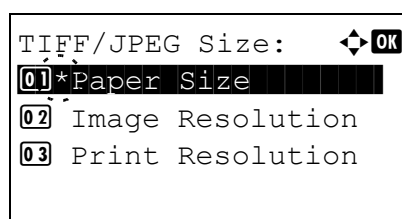

1 In the Page Setting menu, press Δ or ∇ to select TIFF/JPEG Size.

2 Press **[OK]**. The TIFF/JPEG Size screen appears.

The options available in TIFF/JPEG Size are as follows:

- Paper Size (default)
Images are resized so that they fill the paper size when printed.
- Image Resolution
Image files are printed at the resolution specified in the resolution information. Images with no resolution information are printed using the Paper Size setting.
- Print Resolution
Images are printed using a 1-to-1 correspondence between the image file pixels and printed dots. For example, the printed size of a 600 x 300-pixel image file is 1 inch x 1/2 inch.

3 Press Δ or ∇ to select whether TIFF/JPEG Size mode is enabled.

4 Press **[OK]**. The TIFF/JPEG Size setting is set and the Page Setting menu reappears.



Note Images are automatically rotated during printing to provide a closer match between the aspect ratios of the image file and the paper used for printing.

User Name (The User Name display settings)

Set whether the user name set in the printer driver is displayed.

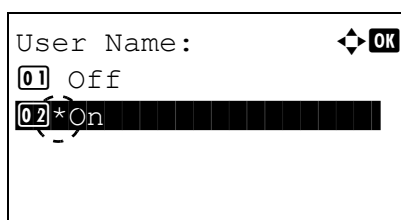

- 1 In the `Print Settings` menu, press Δ or ∇ to select `User Name`.
- 2 Press **[OK]**. The `User Name` screen appears.

- 3 Press Δ or ∇ to select `On` or `Off`.
- 4 Press **[OK]**. The `User Name` setting is set and the `Print Settings` menu reappears.

Job Name (The Job Name display settings)

Set whether the job name set in the printer driver is displayed.

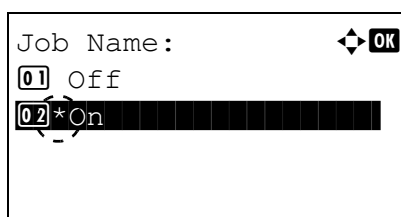

- 1 In the `Print Settings` menu, press Δ or ∇ to select `Job Name`.
- 2 Press **[OK]**. The `Job Name` screen appears.

- 3 Press Δ or ∇ to select `On` or `Off`.
- 4 Press **[OK]**. The `Job Name` setting is set and the `Print Settings` menu reappears.

Network (Network settings)

This printer supports TCP/IP and TCP/IP (IPv6) protocols.

IP is an abbreviation for Internet Protocol. This printer routinely uses the TCP/IP (IPv4) protocol, but provides a separate setting for the next-generation IP, IPv6.

TCP/IP (IPv4) uses 32-bit IP addresses, but the rapid growth in the number of Internet users has resulted in a shortage of IP addresses. IPv6 was developed to expand the range of available IP addresses by using 128-bit IP addresses.

The options available in the Network settings are as follows:

- TCP/IP (Enable/Disable TCP/IP)...4-54
- IPv4 Setting (TCP/IP IPv4 settings)...4-55
- IPv6 Setting (TCP/IP IPv6 settings)...4-58
- Protocol Detail (Detailed settings for the network protocol)...4-60
- Restart Network (Restarting the network card)...4-61

 **Note** Check with your network administrator when selecting the network setting. After all network related settings have been done, restart the network. Refer to *Restart Network (Restarting the network card)* on page 4-61. This is mandatory to make the settings effective!

When Command Center RX is used, network parameters and security settings can be conveniently changed and checked from your PC. For more information, refer to the *Command Center RX User Guide*.

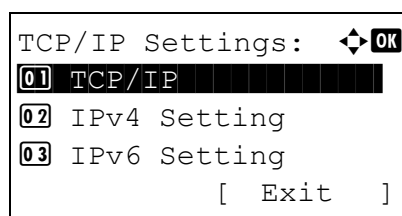
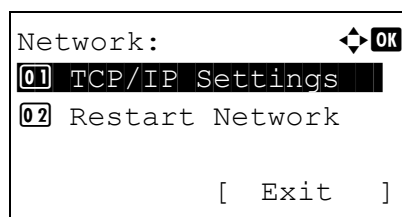

- 1 Press **[Menu]**.
- 2 Press Δ or ∇ to select **Network**.
- 3 Press **[OK]**. The **Network** menu screen appears.
- 4 Select **TCP/IP Settings** and press **[OK]**. The **TCP/IP Settings** menu screen appears.

TCP/IP (Enable/Disable TCP/IP)

The TCP/IP system refers to the Internet system, which has a 5-layer structure consisting of the interface layer, link layer, network (IP) layer, transport (TCP/UDP) layer and application layer.

The interface layer is a key layer in the TCP/IP system that provides an abstracted interface that is not dependent on the link (communication line: frame relay or Ethernet, etc.) to the IP module (IP layer). This means that the IP module can use this abstracted interface (which is not dependent on the link type) to exchange IP packets back and forth with the link layer.

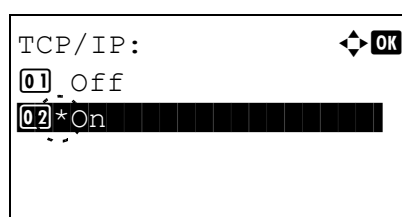

- 1 In the **TCP/IP Settings** menu, press Δ or ∇ to select **TCP/IP**.
- 2 Press **[OK]**. The **TCP/IP** screen appears.

- 3 Press Δ or ∇ to select whether TCP/IP is enabled.
- 4 Press **[OK]**. The TCP/IP setting is set and the TCP/IP Settings menu reappears.

IPv4 Setting (TCP/IP IPv4 settings)

This selects the settings for TCP/IP (IPv4).

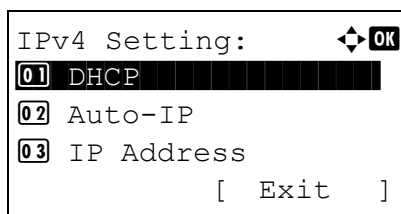

- 1 In the TCP/IP Settings menu, press Δ or ∇ to select IPv4 Setting.
- 2 Press **[OK]**. The IPv4 Setting menu screen appears.

The options available in the TCP/IP (IPv4) settings are as follows:

- DHCP (DHCP setting)...4-55
- Auto-IP (Auto-IP setting)...4-55
- IP Address (IP address setting)...4-56
- Subnet Mask (Subnet mask setting)...4-56
- Default Gateway (Gateway setting)...4-57
- Bonjour (Bonjour setting)...4-58

IMPORTANT The DHCP, Auto-IP, IP address, subnet mask, default gateway and Bonjour menu options for TCP/IP (IPv4 settings) are displayed when TCP/IP is enabled.

DHCP (DHCP setting)

DHCP (Dynamic Host Configuration Protocol) is the protocol that assigns the information required to establish a network connection when a host attempts to connect to the network (Internet). This information includes the IP address of the local node and the default router (the router in the host's own network system) and the DNS (Domain Name System) server. DHCP is an extension of the BOOTP (Bootstrap) startup protocol.

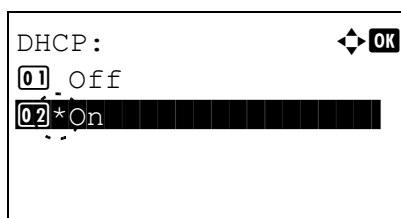

- 1 In the IPv4 Setting menu, press Δ or ∇ to select DHCP.
- 2 Press **[OK]**. The DHCP screen appears.

- 3 Press Δ or ∇ to select whether DHCP is enabled.
- 4 Press **[OK]**. The DHCP setting is set and the IPv4 Setting menu reappears.

Auto-IP (Auto-IP setting)

This protocol is used for automatic assignment of an IP address when you connect to a small network that does not have a DHCP server. Select an address from the range 169.254.0.1 to 169.254.255.254, and if no other device on the network is using that address, it is used as your address.

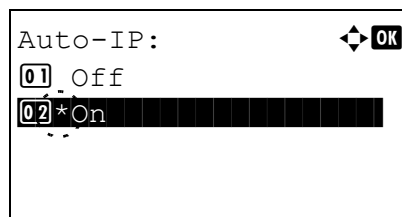

- 1 In the IPv4 Setting menu, press Δ or ∇ to select `Auto-IP`.
- 2 Press **[OK]**. The `Auto-IP` screen appears.

- 3 Press Δ or ∇ to select whether `Auto-IP` is enabled.
- 4 Press **[OK]**. The `Auto-IP` setting is set and the `IPv4 Setting` menu reappears.

IP Address (IP address setting)

An IP address is the address of a network device such as a computer and is included in IP packets as needed for the sending and receiving of Internet data (IP packets). (IP addresses can be either destination addresses or source addresses.)

Specifically, an IP address is a bit string consisting of a host address (or host section) that identifies a computer (host) connected to the Internet and a network address (or network section) that identifies the network to which that computer belongs (or more specifically, the computer's network interface). Bit strings (IP addresses) that are unique throughout the entire Internet system are allocated to each computer or interface.

The IP addresses currently used on the Internet (IPv4) have a fixed length of 32 bits.



Note When you enter the IP address, be sure to set the `DHCP` setting to `Off`.

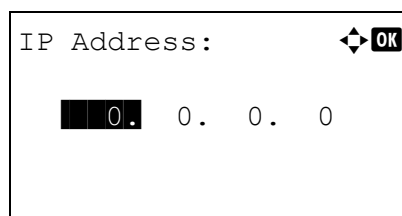

- 1 In the `IPv4 Setting` menu, press Δ or ∇ to select `IP Address`.
- 2 Press **[OK]**. The `IP Address` screen appears.

- 3 Use the numeric keys or press Δ or ∇ to set the IP address.
You can set any value between 000 and 255.
Increase or reduce the figures by pressing Δ or ∇ .
Use \triangleleft and \triangleright to move the position being entered, which is shown highlighted.
- 4 Press **[OK]**. The IP address is stored and the `IPv4 Setting` menu reappears.

Subnet Mask (Subnet mask setting)

The subnet mask is a way of augmenting the network address section of an IP address.

A subnet mask represents all network address sections as 1 and all host address sections as 0. The number of bits in the prefix indicates the length of the network address. The term "prefix" refers to something added to the beginning and, in this context, indicates the first section of the IP address.

When an IP address is written, the length of the network address can be indicated by the prefix length after a forward slash (/). For example, "24" in the address "133.210.2.0/24". In this way, "133.210.2.0/24" denotes the IP address "133.210.2.0" with a 24-bit prefix (network section).

This new network address section (originally part of the host address) made possible by the subnet mask is referred to as the subnet address.



Note When you enter the subnet mask, be sure to set the DHCP setting to Off.

- 1 In the IPv4 Setting menu, press Δ or ∇ to select Subnet Mask.
- 2 Press [OK]. The Subnet Mask screen appears.

- 3 Use the numeric keys or press Δ or ∇ to set the subnet mask. You can set any value between 000 and 255. Increase or reduce the figures by pressing Δ or ∇ . Use \triangleleft and \triangleright to move the position being entered, which is shown highlighted.
- 4 Press [OK]. The subnet mask setting is stored and the IPv4 Setting menu reappears.

Default Gateway (Gateway setting)

Gateway generally refers to a protocol conversion device used to allow networks with differing protocol systems to interconnect.

For example, a "Gateway" device is required to connect a different closed network (using its own protocols) to the open Internet (using TCP/IP).

By installing a gateway, the communications protocols and data display modes on different networks can be made compatible.

On TCP/IP networks, the term gateway is used to refer to routers.



Note Before you enter the gateway, be sure to set the DHCP setting to Off.

- 1 In the IPv4 Setting menu, press Δ or ∇ to select Default Gateway.
- 2 Press [OK]. The Default Gateway screen appears.

- 3 Use the numeric keys or press Δ or ∇ to set the default gateway. You can set any value between 000 and 255. Increase or reduce the figures by pressing Δ or ∇ . Use \triangleleft and \triangleright to move the position being entered, which is shown highlighted.
- 4 Press [OK]. The default gateway is stored and the IPv4 Setting menu reappears.

Bonjour (Bonjour setting)

Bonjour, also known as zero-configuration networking, is a service that automatically detects computers, devices and services on an IP network.

Bonjour, because an industry-standard IP protocol is used, allows devices to automatically recognize each other without an IP address being specified or DNS server being set.

Bonjour also sends and receives network packets by UDP port 5353. If a firewall is enabled, the user must check that UDP port 5353 is left open so that Bonjour will run correctly. Some firewalls are set up so as to reject only certain Bonjour packets. If Bonjour does not run stably, check the firewall settings and ensure that Bonjour is registered on the exceptions list and that Bonjour packets are accepted. If you install Bonjour on Windows XP Service Pack 2 or later, the Windows firewall will be set up correctly for Bonjour.

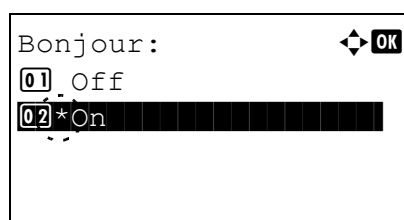

- 1 In the IPv4 Setting menu, press Δ or ∇ to select Bonjour.
- 2 Press [OK]. The Bonjour screen appears.

- 3 Press Δ or ∇ to select whether automatic detection is enabled.
- 4 Press [OK]. The automatic detection setting is set and the IPv4 Setting menu reappears.

IPv6 Setting (TCP/IP IPv6 settings)

This selects the settings for TCP/IP (IPv6).

TCP/IP (IPv6) is based on the current Internet protocol, TCP/IP (IPv4). IPv6 is the next-generation Internet protocol and expands the available address space, which resolves the problem of the lack of addresses under IPv4, while also introducing other improvements such as additional security functionality and the capacity to prioritize data transmission.

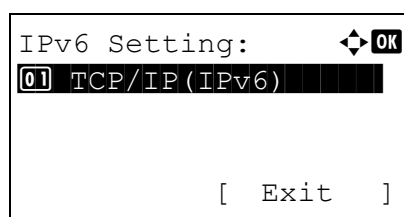

- 1 In the TCP/IP Settings menu, press Δ or ∇ to select IPv6 Setting.
- 2 Press [OK]. The IPv6 Setting menu screen appears.

The options available in the TCP/IP (IPv6) settings are as follows:

- TCP/IP (IPv6) (Enable/disable TCP/IP (IPv6))...4-59
- RA (Stateless) (RA (Stateless) setting)...4-59
- DHCPv6 (DHCPv6 setting)...4-59

IMPORTANT The RA (Stateless) and DHCPv6 menu options for TCP/IP (IPv6) are displayed when TCP/IP (IPv6) is enabled.

TCP/IP (IPv6) (Enable/disable TCP/IP (IPv6))

This specified whether TCP/IP (IPv6) is used.

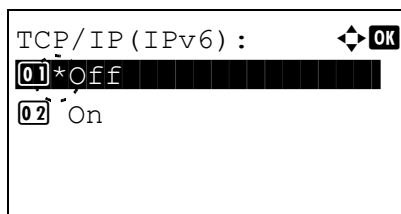

1 In the IPv6 Setting menu, press Δ or ∇ to select TCP/IP (IPv6).

2 Press **[OK]**. The TCP/IP (IPv6) screen appears.

3 Press Δ or ∇ to select whether TCP/IP (IPv6) is enabled.

4 Press **[OK]**. The TCP/IP (IPv6) setting is set and the IPv6 Setting menu reappears.

RA (Stateless) (RA (Stateless) setting)

The IPv6 router communicates (transmits) information such as the global address prefix using ICMPv6. This information is the Router Advertisement (RA).

ICMPv6 stands for Internet Control Message Protocol, and is an IPv6 standard defined in the RFC 2463 "Internet Control Message Protocol (ICMPv6) for the Internet Protocol Version 6 (IPv6) Specification".

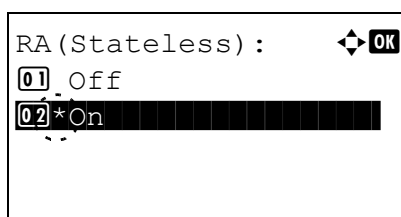

1 In the IPv6 Setting menu, press Δ or ∇ to select RA (Stateless).

2 Press **[OK]**. The RA (Stateless) screen appears.

3 Press Δ or ∇ to select whether RA (Stateless) is enabled.

4 Press **[OK]**. The RA (Stateless) setting is set and the IPv6 Setting menu reappears.

DHCPv6 (DHCPv6 setting)

DHCPv6 is the next-generation of the Internet's Dynamic Host Configuration Protocol and supports IPv6. It extends the BOOTP startup protocol that defines the protocols used for transferring configuration information to hosts on the network.

DHCPv6 permits the DHCP server to use its expanded functionality to send configuration parameters to an IPv6 node. Because the network addresses that can be used are allocated automatically, the IPv6 node management workload is reduced in systems where the administrator has to exercise close control over IP address allocation.

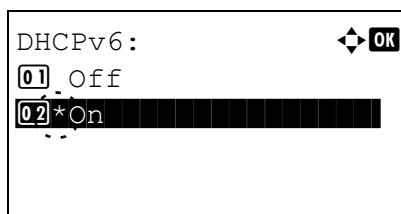

1 In the IPv6 Setting menu, press Δ or ∇ to select DHCPv6.

2 Press **[OK]**. The DHCPv6 screen appears.

3 Press Δ or ∇ to select whether DHCPv6 is enabled.

4 Press **[OK]**. The DHCPv6 setting is set and the IPv6 Setting menu reappears.

Protocol Detail (Detailed settings for the network protocol)

This selects the settings for Protocol Detail.

Item	Description	Default Setting	Restarting the System [†]
NetBEUI	Selects whether or not to receive documents using NetBEUI.	On	×
SNMPv3	Set SNMPv3.	Off	●
FTP (Server)	Select whether or not to receive documents using FTP.	On	●
SNMP	Select whether or not to communicate using SNMP.	On	●
SMTP (E-mail TX)	Select whether or not to send e-mail using SMTP.	Off	×
POP3 (E-mail RX)	Select whether or not to receive e-mail using POP3.	Off	×
RAW Port	Select whether or not to communicate using RAW Port.	On	●
LPD	Select whether or not to receive documents using LPD as the network protocol.	On	●
HTTP	Select whether or not to communicate using HTTP.	On	●
LDAP	Select whether or not to use LDAP.	Off	×

[†] ●: The machine must be restarted after the setting is changed.

×: The machine does not need to be restarted after the setting is changed.

Use the procedure below.

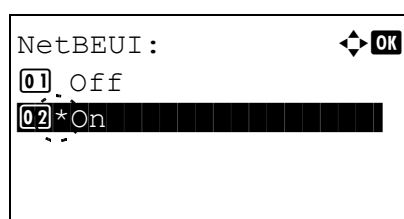
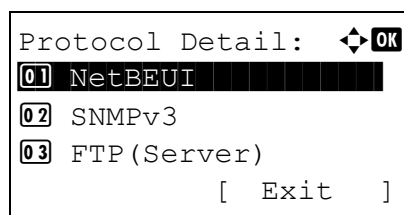

1 In the TCP/IP Settings menu, press Δ or ∇ to select Protocol Detail.

2 Press [OK]. The Protocol Detail menu screen appears.

3 Press Δ or ∇ to select the item for which you want to make settings.

4 Press [OK]. This displays the setting screen for the item selected in step 3.

The screen shown is the one when NetBEUI is selected.

5 Press Δ or ∇ to select On or Off.

6 Press [OK]. The Protocol Detail menu reappears.

Restart Network (Restarting the network card)

After all network related settings have been done, restart the network card of the device. This is mandatory to make the settings effective.

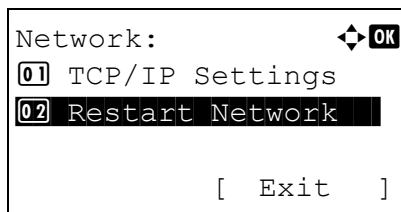

- 1 In the `Network` menu, press `△` or `▽` to select `Restart Network`.
- 2 Press `[OK]`. A confirmation screen appears.

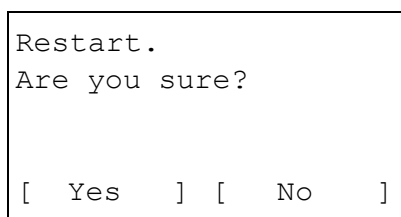

- 3 Press `[Yes]` (**[Left Select]**). The message `Restarting...` appears and the network is restarted. Pressing `[No]` (**[Right Select]**) returns to the `Network` menu without restarting the network.

Optional Network (Optional Network settings)

This selects the settings for the optional network interface kit (IB-50) or wireless network interface kit (IB-51).

 **Note** This is only displayed when a network interface kit (IB-50) or wireless network interface kit (IB-51) is installed as an option.

The options available in the Optional Network settings are as follows:

- Wireless Network (Wireless network settings)...4-63
- Basic (Basic settings for the optional network interface kit)...4-69
- Communication (Select the network interface to use)...4-72

 **Note** Check with your network administrator when selecting the network setting. After all network related settings have been done, restart the network. Refer to *Restart Network (Restarting the optional network interface kit)* on page 4-72. This is mandatory to make the settings effective!

When the web page for IB-50 or IB-51 is used, network parameters and security settings can be conveniently changed and checked from your PC. For more information, refer to the *IB-50/IB-51 User's Manual*.

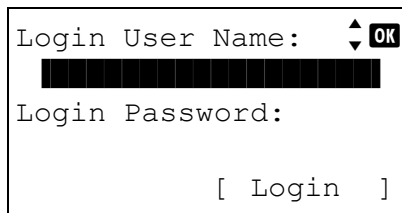
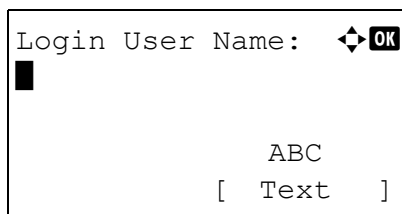
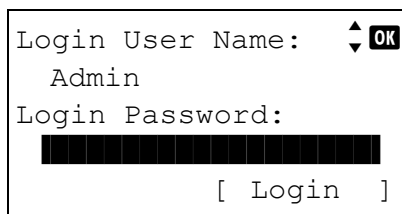
- 1 Press **[Menu]**.
- 2 Press Δ or ∇ to select `Optional Network`.
- 3 Press **[OK]**. The Login screen appears.



Note When user login administration is set:

- When logged in as an administrator, the log in screen is not displayed and the `Optional Network` menu screen is displayed.
- The setting is not possible when logged in as anyone other than an administrator. Log in again as an administrator.

- 4 With the `Login User Name` entry field selected, press **[OK]**. The `Login User Name` entry screen is displayed.

- 5 Enter the Login User Name using the numeric keys then press **[OK]**. The log in screen reappears.



Note The initial setting for the administrator's Login User Name is "Admin".

For details on entering characters, refer to *Character Entry Method* on page A-2.

- 6 Press Δ or ∇ to select the `Login Password` entry field.

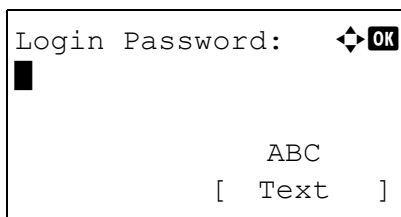

7 Press **[OK]**. The `Login Password` entry screen is displayed.

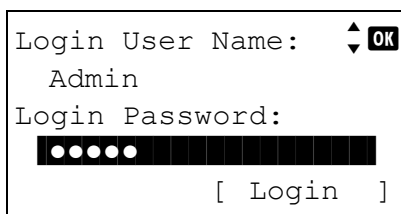

8 Enter the Login Password using the numeric keys then press **[OK]**. The login screen reappears.



Note The initial setting for the administrator's Login Password is "Admin".

For details on entering characters, refer to *Character Entry Method* on page A-2.

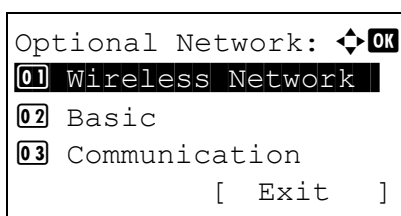

9 Pressing `[Login]` (**[Right Select]**). If the entered Login User Name and Login Password are correct, the `Optional Network` menu appears showing a list of available options.

Wireless Network (Wireless network settings)

This selects the settings for Wireless network.



Note `Wireless Network` is only displayed when the optional wireless network interface kit (IB-51) is installed.

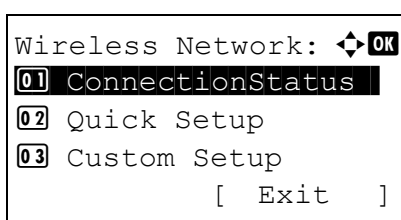

1 In the `Optional Network` menu, press Δ or ∇ to select `Wireless Network`.

2 Press **[OK]**. The `Wireless Network` menu screen appears.

The following operations are possible:

- `ConnectionStatus` (Wireless network connection status check)...4-63
- `Quick Setup` (Quick setup for the wireless network)...4-64
- `Custom Setup` (Detailed settings for the wireless network)...4-66

ConnectionStatus (Wireless network connection status check)

When the optional wireless network interface kit (IB-51) is installed, you can check the status of the wireless network.

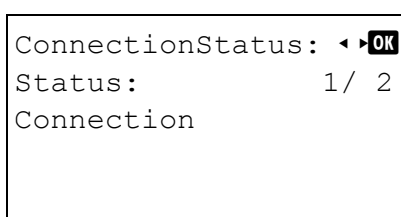

1 In the `Wireless Network` menu, press Δ or ∇ to select `ConnectionStatus`.

2 Press **[OK]**. The `ConnectionStatus` screen appears.

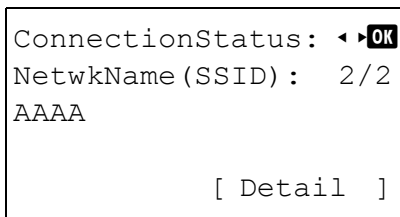

3 Press ◀ or ▶. The NetwkName (SSID) is displayed.

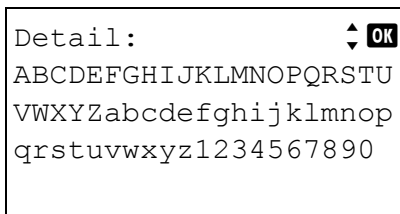

If the entire name shown as the NetwkName (SSID) will not fit on one line, pressing [Detail] (**[Right Select]**) changes to a 3-line name display.

Quick Setup (Quick setup for the wireless network)

When connecting to an access point which supports the automatic wireless network setup, you can select the connection settings using Quick Setup.

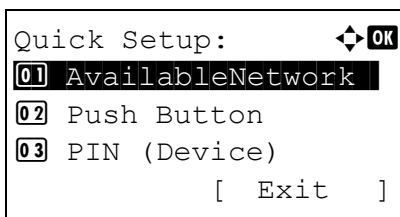

1 In the Wireless Network menu, press ▲ or ▼ to select Quick Setup.

2 Press **[OK]**. The Quick Setup menu screen appears.

The following operations are possible:

- AvailableNetwork (Display the access points)
- Push Button (Connect using Push Button)
- PIN (Device) (Connect using a PIN code (for the wireless network interface kit))
- PIN (Terminal) (Connect using a PIN code (for the access point))

AvailableNetwork (Display the access points)

Displays the access points which can be connected to.

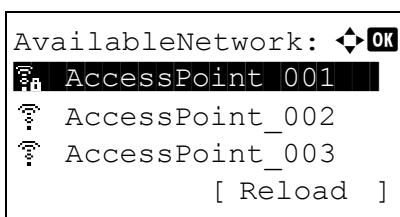

1 In the Quick Setup menu, press ▲ or ▼ to AvailableNetwork.

2 Press **[OK]**. The AvailableNetwork screen appears.

 **Note** If you cannot find the desired access point, press [Reload] (**[Right Select]**) to update the information.

3 Press ▲ or ▼ to select the access point to connect to.

4 Press **[OK]**. The connection with the access point is started.

When it is necessary to enter an encryption key, the WEP Key entry screen or Preshared Key entry screen appears.

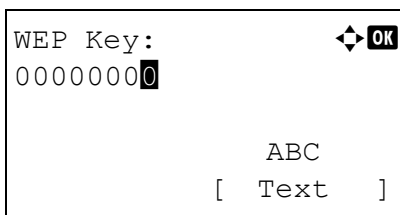

When a WEP Key must be entered:

Enter the WEP Key using the numeric keys and press **[OK]**.

 Up to 26 characters can be entered. For details on entering characters, refer to *Character Entry Method* on page A-2.

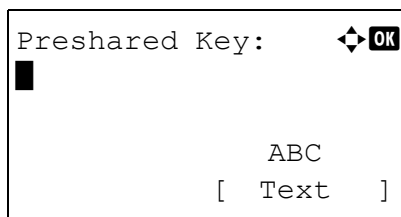

When a Preshared Key must be entered:

Enter the Preshared Key using the numeric keys and press **[OK]**.



Note The number of characters is between 8 and 64. For details on entering characters, refer to *Character Entry Method* on page A-2.

Push Button (Connect using Push Button)

When the access point supports the automatic wireless network setup button, you can configure the wireless settings automatically using the button and the panel operation of the printer.

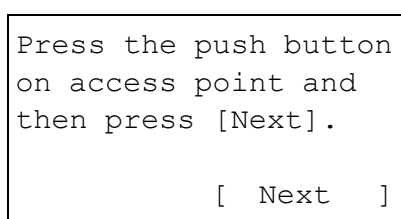

- 1 In the `Quick Setup` menu, press Δ or ∇ to select `Push Button`.
- 2 Press **[OK]**. A confirmation message is displayed.

- 3 Press the automatic wireless network setup button on the access point.
- 4 Press `[Next]` (**[Right Select]**). The message `Connecting...` appears and the connection with the access point starts.

PIN (Device) (Connect using a PIN code (for the wireless network interface kit))

The connection is started using the PIN code for the machine. The PIN code displayed should be entered at the access point. The PIN code for the machine is generated automatically.

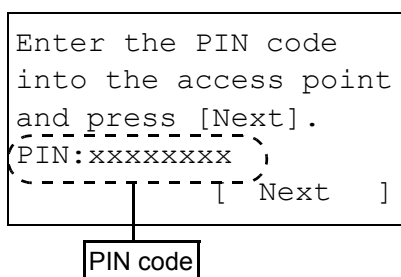

- 1 In the `Quick Setup` menu, press Δ or ∇ to select `PIN (Device)`.
- 2 Press **[OK]**. A PIN code is displayed on the Message display.

- 3 Write down the PIN code displayed on the Message display.
- 4 Press `[Next]` (**[Right Select]**). The message `Connecting...` appears.
- 5 At the access point, immediately enter the PIN code which wrote down on step 3. The connection with the access point starts.

PIN (Terminal) (Connect using a PIN code (for the access point))

The connection is started using the PIN code for the access point. Enter the PIN code for the access point. For details of the PIN code for the access point, refer to the Operation Guide of the access point.

- 1 In the `Quick Setup` menu, press Δ or ∇ to select `PIN (Terminal)`.

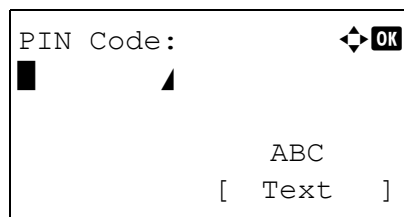

2 Press **[OK]**. The PIN code entry screen appears.

3 Enter the PIN Code using the numeric keys.



Note Up to 8 characters can be entered. For details on entering characters, refer to *Character Entry Method on page A-2*.

4 Press **[OK]**. The message `Connecting...` appears and the connection with the access point starts.

Custom Setup (Detailed settings for the wireless network)

It is possible to change the detailed settings of the wireless network.

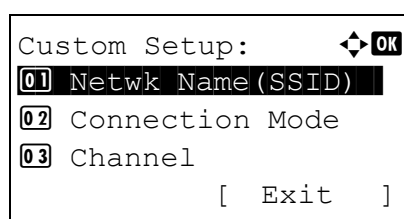

1 In the Wireless Network menu, press Δ or ∇ to select Custom Setup.

2 Press **[OK]**. The Custom Setup menu screen appears.

The following operations are possible:

- Netwk Name (SSID) (Registration of the access point's SSID)
- Connection mode (Switch between connection modes)
- Channel (Channel settings)
- Netwk Authentic. (Network Authentication setting)
- Encryption (Encryption settings)

Netwk Name (SSID) (Registration of the access point's SSID)

This sets the SSID (Service Set Identifier) for the wireless network access point the machine will be connected to.

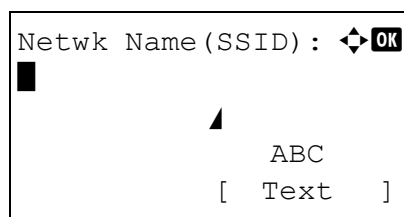

1 In the Custom Setup menu, press Δ or ∇ to select Netwk Name (SSID).

2 Press **[OK]**. The Netwk Name (SSID) entry screen appears.

3 Enter the access point's SSID using the numeric keys.



Note Up to 32 characters can be entered. For details on entering characters, refer to *Character Entry Method on page A-2*.

4 Press **[OK]**. The Custom Setup menu reappears.

Connection mode (Switch between connection modes)

This selects the method for connecting to the wireless network. Set Ad Hoc when machines will be connected directly with each other, without going through an access point.

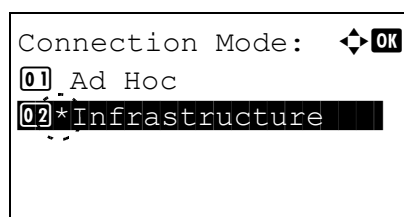

1 In the Custom Setup menu, press Δ or ∇ to select Connection Mode.

2 Press **[OK]**. The Connection Mode screen appears.

The available Connection Mode are as follows:

- Ad Hoc (Connect without going through access points)
- Infrastructure (Connect via an access point)

- 3 Press Δ or ∇ to select the connection mode.
- 4 Press **[OK]**. The `Custom Setup` menu reappears.

Channel (Channel settings)

This sets the Channel to be used in the wireless network.

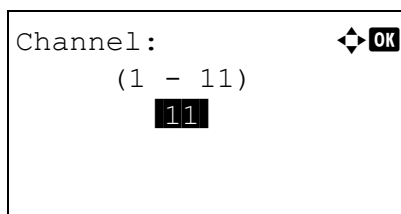

- 1 In the `Custom Setup` menu, press Δ or ∇ to select `Channel`.
- 2 Press **[OK]**. The `Channel` screen appears.

- 3 Enter the Channel number using the numeric keys, Δ or ∇ .



Note The Channel can be set between 1 and 11.

- 4 Press **[OK]**. The `Custom Setup` menu reappears.

Netwk Authentic. (Network Authentication setting)

This sets the authentication method to be used when connecting to an access point.



Note You can also configure the network authentication setting for WPA-Enterprise and WPA2-Enterprise using the web page of the optional wireless network interface kit (IB-51). For details, refer to the *IB-51 User's Manual*.

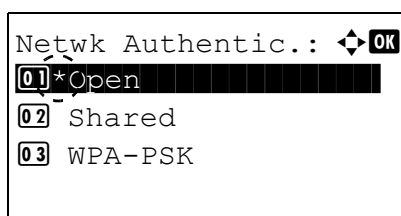

- 1 In the `Custom Setup` menu, press Δ or ∇ to select `Netwk Authentic..`

- 2 Press **[OK]**. The `Netwk Authentic.` screen appears.

The available authentication methods are as follows:

Open

Shared

WPA-PSK

WPA2-PSK



Note WPA-PSK and WPA2-PSK are only displayed when `Infrastructure` has been set as the *Connection mode* (*Switch between connection modes*) on page 4-66.

- 3 Press Δ or ∇ to select the desired authentication method.

- 4 Press **[OK]**. The `Custom Setup` menu reappears.

Encryption (Encryption settings)

This selects the encryption settings.



Note This setting is not displayed when the setting for *Netwk Authentic. (Network Authentication setting)* on page 4-67 is set to use an authentication method other than `Open`, `Shared`, `WPA-PSK` and `WPA2-PSK`, using `Utility`.

- 1 In the `Custom Setup` menu, press Δ or ∇ to select `Encryption`.

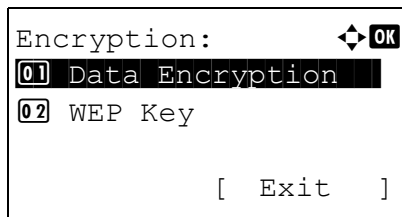

2 Press **[OK]**. The *Encryption* screen appears.

The following operations are possible:

- Data Encryption (Data Encryption setting)...4-68
- WEP Key (WEP Key settings)...4-68
- Preshared Key (Preshared Key settings)...4-69



Note WEP Key is displayed when *Netwk Authentic.* (*Network Authentication setting*) on page 4-67 is set to Open or Shared.

Preshared Key is displayed when *Netwk Authentic.* (*Network Authentication setting*) on page 4-67 is set to WPA-PSK or WPA2-PSK.

Data Encryption (Data Encryption setting)

This sets the encryption method.

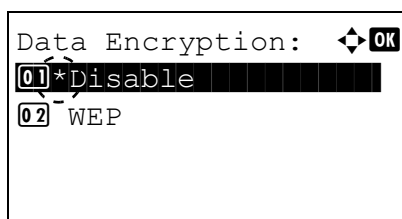

1 In the *Encryption* menu, press Δ or ∇ to select *Data Encryption*.

2 Press **[OK]**. The *Data Encryption* screen appears.



Note The encryption methods that can be selected vary depending on the authentication method set in *Netwk Authentic.* (*Network Authentication setting*) on page 4-67.

Disable or WEP can be selected when Open or Shared is set.

TKIP, AES or Auto can be selected when WPA-PSK is set.

AES can be selected when WPA2-PSK is set.

3 Press Δ or ∇ to select the desired encryption method.

4 Press **[OK]**. The *Encryption* menu reappears.

WEP Key (WEP Key settings)

This registers the WEP Key.

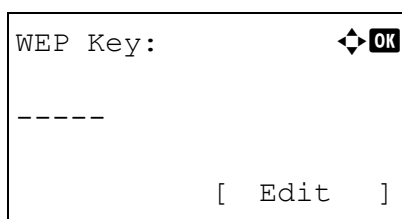

1 In the *Encryption* menu, press Δ or ∇ to select *WEP Key*.

2 Press **[OK]**. The *WEP Key* screen appears.

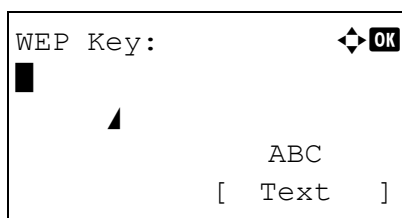

3 Press **[Edit]** (**[Right Select]**). The *WEP Key* entry screen appears.

4 Enter the WEP Key using the numeric keys.



Note Up to 26 characters can be entered. For details on entering characters, refer to *Character Entry Method* on page A-2.

5 Press **[OK]**. The *Encryption* menu reappears.

Preshared Key (Preshared Key settings)

This registers the Preshared Key.

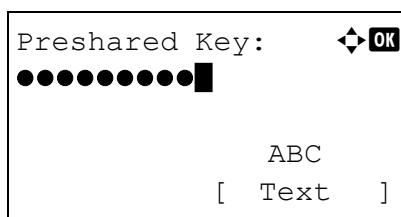
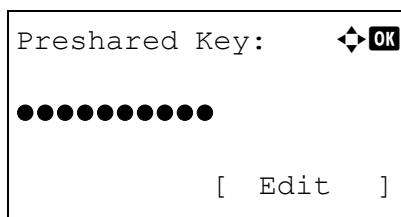

- 1 In the `Encryption` menu, press Δ or ∇ to select `Preshared Key`.
- 2 Press **[OK]**. The `Preshared Key` screen appears.

- 3 Press **[Edit]** (**[Right Select]**). The `Preshared Key` entry screen appears.

- 4 Enter the Preshared Key using the numeric keys.



Note The number of characters is between 8 and 64. For details on entering characters, refer to *Character Entry Method* on page A-2.

- 5 Press **[OK]**. The `Encryption` menu reappears.

Basic (Basic settings for the optional network interface kit)

This selects the basic settings for the optional network interface kit (IB-50) or optional wireless network interface kit (IB-51) network.

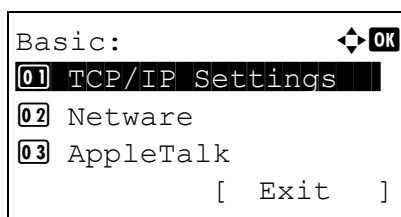

- 1 In the `Optional Network` menu, press Δ or ∇ to select `Basic`.
- 2 Press **[OK]**. The `Basic` menu screen appears.

The following operations are possible:

- TCP/IP Settings (TCP/IP Settings for the optional network interface kit)...4-69
- Netware (NetWare setting)...4-70
- AppleTalk (AppleTalk setting)...4-70
- IPSec (IPSec setting)...4-71
- LAN Interface (LAN Interface setting)...4-71
- MACAddressFilter (MAC address filtering setting)...4-72
- Restart Network (Restarting the optional network interface kit)...4-72

TCP/IP Settings (TCP/IP Settings for the optional network interface kit)

This selects the TCP/IP settings.

The options available in the TCP/IP Settings are as follows:

- TCP/IP (Enable/Disable TCP/IP)
- IPv4 Setting (TCP/IP IPv4 settings)
- IPv6 Setting (TCP/IP IPv6 settings)

- 1 In the `Basic` menu, press Δ or ∇ to select `TCP/IP Settings`.

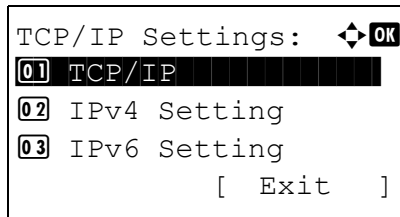

- 2 Press **[OK]**. The TCP/IP Settings menu screen appears.

TCP/IP (Enable/Disable TCP/IP)

This specifies whether TCP/IP is used.

The method for setting is the same as for the standard Network settings. For details, refer to *TCP/IP (Enable/Disable TCP/IP)* on page 4-54.

IPv4 Setting (TCP/IP IPv4 settings)

This selects the settings for TCP/IP (IPv4). The method for setting is the same as for the standard Network settings. For details, refer to *IPv4 Setting (TCP/IP IPv4 settings)* on page 4-55.

IPv6 Setting (TCP/IP IPv6 settings)

This selects the settings for TCP/IP (IPv6). The method for setting is the same as for the standard Network settings. For details, refer to *IPv6 Setting (TCP/IP IPv6 settings)* on page 4-58.

Netware (NetWare setting)

NetWare is a PC-based network operating system specifically for servers. NetWare is a client-server system that operates by installing the NetWare OS on the server and dedicated client modules (NetWare clients) on the client machines (running MS-DOS, OS/2, Windows, etc.). The basic network layer protocol used is NetWare's own IPX (Internetwork Packet eXchange)/SPX (Sequenced Packet eXchange), but the system also supports TCP/IP.

The feature of the NetWare OS is that it is specifically for servers, unlike general-purpose operating systems such as Windows NT and UNIX. Only the minimum required for server operation can be performed from the NetWare OS console on the server. Server and file management is basically carried out using management tools from the clients. Also, all drivers and protocol stacks are in the form of modules called NetWare Loadable Modules (NLMs), and the ability of NLMs to load and unload flexibly and dynamically is a major advantage of this system.

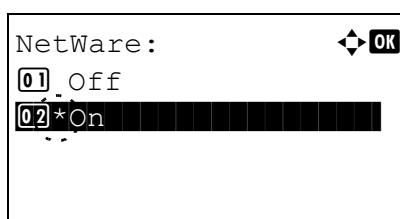

- 1 In the Basic menu, press Δ or ∇ to select Netware.
- 2 Press **[OK]**. The Netware screen appears.
- 3 Press Δ or ∇ to select whether NetWare is enabled.
- 4 Press **[OK]**. The NetWare setting is set and the Basic menu reappears.

AppleTalk (AppleTalk setting)

AppleTalk is a communications protocol used primarily on Macintosh computers and also refers to the Mac OS network functions.

AppleTalk assigns 24-bit network addresses (a 16-bit network section and an 8-bit node address) that are used to identify devices (computers, printers, etc.) on the network.

When the power is turned on, a broadcast signal is sent out onto the network and the addresses and machine names are automatically assigned. The default setting is On.

- 1 In the Basic menu, press Δ or ∇ to select AppleTalk.

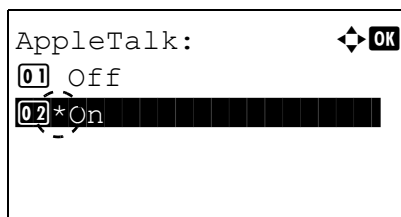

2 Press **[OK]**. The AppleTalk screen appears.

3 Press Δ or ∇ to select whether AppleTalk is enabled.

4 Press **[OK]**. The AppleTalk setting is set and the `Basic` menu reappears.

IPSec (IPSec setting)

IPSec (IP Security Protocol) is a security protocol adopted as the standard by the IETF for authentication and encryption in the third network layer (IP layer).

It can be used with both IPv4 and IPv6.

 **Note** IPv4 uses 32-bit IP addresses and IPv6 uses 128-bit IP addresses.

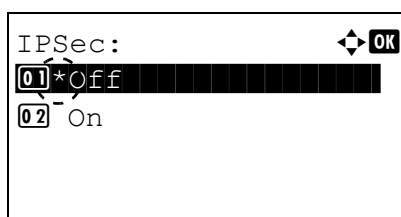

1 In the `Basic` menu, press Δ or ∇ to select IPSec.

2 Press **[OK]**. The IPSec screen appears.

3 Press Δ or ∇ to select whether IPSec is enabled.

4 Press **[OK]**. The IPSec setting is set and the `Basic` menu reappears.

LAN Interface (LAN Interface setting)

Specify the settings for the LAN interface to be used. The default setting is `Auto`.

 **Note** LAN Interface is only displayed when the optional network interface kit (IB-50) is installed.

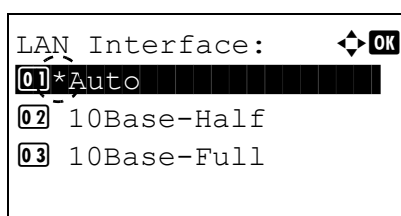

1 In the `Basic` menu, press Δ or ∇ to select LAN Interface.

2 Press **[OK]**. The LAN Interface screen appears.

The available LAN Interface are as follows:

Auto
10Base-Half
10Base-Full
100Base-Half
100Base-Full
1000Base-T

3 Press Δ or ∇ to select the desired LAN Interface.

4 Press **[OK]**. The LAN Interface is set and the `Basic` menu reappears.

MACAddressFilter (MAC address filtering setting)

This sets whether or not to enable MAC address filtering.

 **Note** The detailed settings for MAC address filtering are selected using the optional network interface kit utility software.

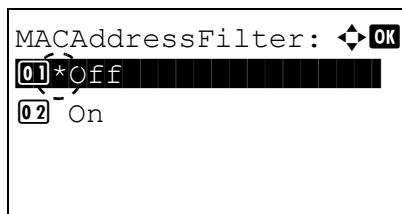

- 1 In the `Basic` menu, press Δ or ∇ to select `MACAddressFilter`.
- 2 Press **[OK]**. The `MACAddressFilter` screen appears.

- 3 Press Δ or ∇ to select whether MAC address filtering is enabled.
- 4 Press **[OK]**. The MAC address filtering setting is set and the `Basic` menu reappears.

Restart Network (Restarting the optional network interface kit)

After all network related settings have been done, restart the network card of the device. This is mandatory to make the settings effective.

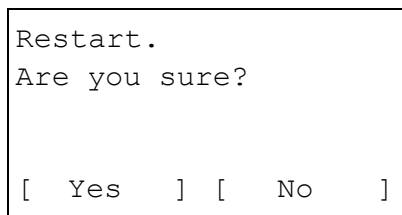

- 1 In the `Basic` menu, press Δ or ∇ to select `Restart Network`.
- 2 Press **[OK]**. A confirmation screen appears.

- 3 Press **[Yes] ([Left Select])**. The message `Restarting...` appears and the network is restarted.
Pressing **[No] ([Right Select])** returns to the `Basic` menu without restarting the network.

Communication (Select the network interface to use)

The client function such as the network authentication and the reference of user information via LDAP operates only by the selected interface. This function is mainly used for the network system administrator. For more information about each function, refer to *Command Center RX User Guide* and *IB-50/IB-51 User's Manual*.

 **Note** `Communication` is only displayed on network compatible models.

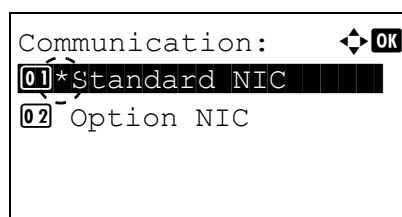

- 1 In the `Optional Network` menu, press Δ or ∇ to select `Communication`.
- 2 Press **[OK]**. The `Communication` screen appears.

- 3** Press Δ or ∇ to select the desired NIC.
Standard NIC: standard network interface of the printer
Option NIC: optional network interface kit
- 4** Press **[OK]**. The NIC is set and the `Optional Network` menu reappears.

Device Common (Selecting/Setting the common device)

Selects/sets all the functions in this printer.

The options available in Device Common are as follows:

- Language (Selecting the message language)...4-74
- Def. Screen(Box) (Document Box default screen setting)...4-75
- Date Setting (Date and time settings)...4-76
- Buzzer (Alarm (Buzzer) setting)...4-79
- RAM Disk Setting (Using the RAM disk)...4-81
- Format SSD (Formatting the SSD)...4-82
- Format SD Card (Formatting the SD/SDHC memory card)...4-83
- Display Bright. (Display brightness setting)...4-83
- Disp. Backlight (Display backlight setting)...4-84
- Error Handling (Error detection setting)...4-84
- Timer Setting...4-86
- USB KeyboardType (USB keyboard type selection)...4-94
- TonerAlert Level (Setting for the alert level for toner addition)...4-94

IMPORTANT Def. Screen(Box), Format SSD and Format SD Card only appear when the relevant option is installed.

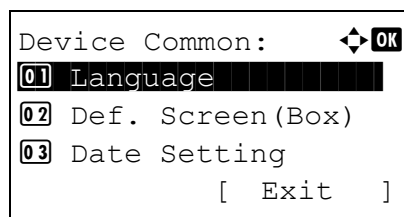

- 1** Press **[MENU]**.
- 2** Press Δ or ∇ to select Device Common.
- 3** Press **[OK]**. The Device Common menu appears showing a list of available options.

Language (Selecting the message language)

You can select the language of the message display by following the procedure given below. You can optionally download messages in other languages. Contact your service technician for information.

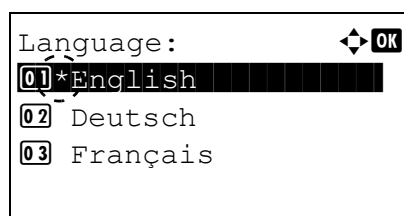

- 1** In the Device Common menu, press Δ or ∇ to select Language.
- 2** Press **[OK]**. The Language screen appears showing the list of languages.

The available languages are as follows:

English
 Deutsch
 Français
 Español
 Italiano
 Nederlands
 Русский
 Português

The optional languages are as follows:

Optional language	Message display
Turkish	Türkçe
Greek	Ελληνικά
Polish	Polski
Czech	Česky
Hungarian	Magyar
Finnish	Suomi
Hebrew	עברית
Arabic	عربي
Swedish	Svenska
Danish	Dansk
Norwegian	Norsk
Romanian	Română
Catalan	Català

If you are using one of the optional languages, it is displayed in place of Português.

- 3 Press Δ or ∇ to select the desired language.
- 4 Press **[OK]**. The language is set and the *Device Common* menu reappears.

Def. Screen(Box) (Document Box default screen setting)

Select the screen to be displayed when **[Document Box]** is pressed.

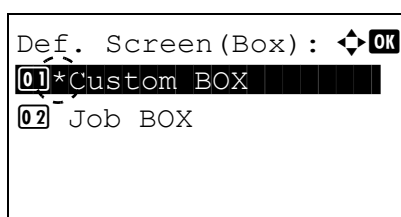

- 1 In the *Device Common* menu screen, press Δ or ∇ to select *Def. Screen(Box)*.
- 2 Press **[OK]**. The *Def. Screen(Box)* screen appears.
- 3 Press Δ or ∇ to select either *Custom BOX* or *Job BOX* as the default screen.
- 4 Press **[OK]**. The default screen is set and the *Device Common* menu reappears.

Date Setting (Date and time settings)

Set the date and time.

IMPORTANT To change the Date Setting, the administrator's Login User Name and Login Password must be entered. For details of the administrator settings, refer to *Administrator* on page 4-116.

If you change the date/time while using an application, you will no longer be able to use the application.

The date and time settings consist of the following items:

- Date (date setting)...4-77
- Time (time setting)...4-77
- Date Format (date format selection)...4-77
- Time Zone (time difference setting)...4-78
- Summer Time (summer time setting)...4-78

1 In the `Device Common` menu, press Δ or ∇ to select `Date Setting`.

2 Press **[OK]**. The Login screen appears.



Note When user login administration is set:

- When logged in as an administrator, the log in screen is not displayed and the `Date Setting` menu screen is displayed.
- The setting is not possible when logged in as anyone other than an administrator. Log in again as an administrator.

3 With the `Login User Name` entry field selected, press **[OK]**. The `Login User Name` entry screen is displayed.

4 Enter the `Login User Name` using the numeric keys then press **[OK]**. The log in screen reappears.



Note The initial setting for the administrator's `Login User Name` is "Admin".

For details on entering characters, refer to *Character Entry Method* on page A-2.

5 Press Δ or ∇ to select the `Login Password` entry field.

6 Press **[OK]**. The `Login Password` entry screen is displayed.

```

Login User Name:  ▲ OK
  Admin
Login Password:
  ●●●●●●●●●●
                [ Login ]

```

- 7 Enter the Login Password using the numeric keys then press **[OK]**. The login screen reappears.



Note The initial setting for the administrator's Login Password is "Admin".

For details on entering characters, refer to *Character Entry Method on page A-2*.

```

Date Setting:    ▲ OK
01 Date
02 Time
03 Date Format
                [ Exit ]

```

- 8 Pressing **[Login]** (**[Right Select]**). If the entered Login User Name and Login Password are correct, the Date Setting menu appears showing a list of available options.

Date (date setting)

```

Date:           ▲ OK
Month   Day   Year
 04    /   04   / 2012
(Time Zone:Estn Time)

```

- 1 In the Date Setting menu, press Δ or ∇ to select Date.
- 2 Press **[OK]**. The Date screen appears.

- 3 Use the numeric keys or press Δ or ∇ to set the year, month, and day.

Use \triangleleft and \triangleright to move the cursor right and left.

- 4 Press **[OK]**. The date is set and the Date Setting menu reappears.

Time (time setting)

```

Time:           ▲ OK
Hour   Min.   Second
 11    :   45   :   50
(Time Zone:Estn Time)

```

- 1 In the Date Setting menu, press Δ or ∇ to select Time.
- 2 Press **[OK]**. The Time screen appears.

- 3 Use the numeric keys or Δ or ∇ to set the hour, minute, and second. Use \triangleleft and \triangleright to move the cursor right and left.

- 4 Press **[OK]**. The time is set and the Date Setting menu reappears.

Date Format (date format selection)

One of three formats can be selected for the date format.

- 1 In the Date Setting menu, press Δ or ∇ to select Date Format.

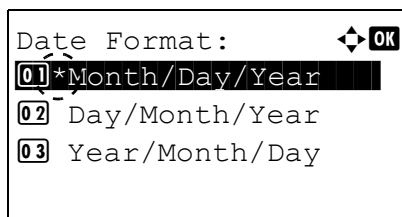

2 Press **[OK]**. The `Date Format` screen appears.

3 Press Δ or ∇ to select the desired date format.

The following date formats can be selected:

Month/Day/Year

Day/Month/Year

Year/Month/Day

4 Press **[OK]**. The date format is set and the `Date Setting` menu reappears.

Time Zone (time difference setting)

Set the time difference from GMT.

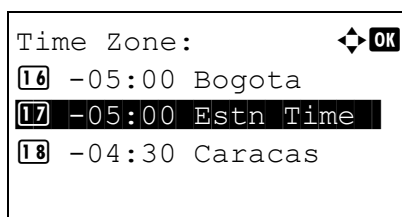

1 In the `Date Setting` menu, press Δ or ∇ to select `Time Zone`.

2 Press **[OK]**. The `Time Zone` screen appears.

3 Press Δ or ∇ to select the location.

4 Press **[OK]**. The time zone is set and the `Date Setting` menu reappears.



Note If you select a region that does not utilize summer time, the summer time setting will not appear.

Summer Time (summer time setting)

Set summer time.

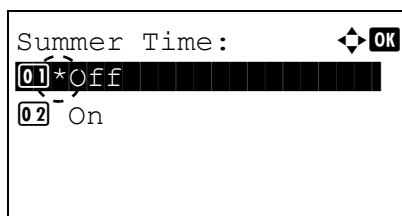

1 In the `Date Setting` menu, press Δ or ∇ to select `Summer Time`.

2 Press **[OK]**. The `Summer Time` screen appears.

3 Press Δ or ∇ to select whether the summer time is enabled.

4 Press **[OK]**. The summer time is set and the `Date Setting` menu reappears.

Buzzer (Alarm (Buzzer) setting)

This function uses tones to notify the user of printer operations and the printer status. This setting is useful, for example, when the printer is located some distance from the user.

The options available in Buzzer are as follows:

- Key Confirmation (Key confirmation tone setting)...4-79
- Job Finish (Job completed tone setting)...4-79
- Ready (Preparation completed tone setting)...4-80
- Error (Error tone setting)...4-80
- Keyboard Confirm (Keyboard confirmation tone setting)...4-80

1 In the `Device Common` menu, press Δ or ∇ to select `Buzzer`.

2 Press **[OK]**. The `Buzzer` screen appears.

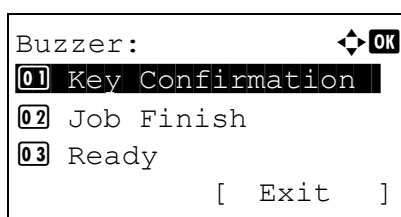

Key Confirmation (Key confirmation tone setting)

When `On` is selected in this setting, a tone sounds each time a key is used. The default setting is `On`.

1 In the `Buzzer` menu screen, press Δ or ∇ to select `Key Confirmation`.

2 Press **[OK]**. The `Key Confirmation` screen appears.

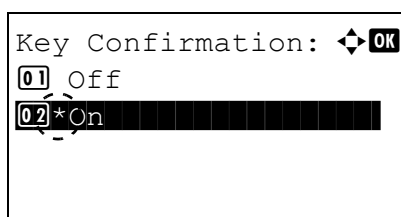

3 Press Δ or ∇ to select whether the key confirmation tone is enabled.

4 Press **[OK]**. The key confirmation tone setting is set and the `Buzzer` menu reappears.

Job Finish (Job completed tone setting)

When `On` is selected in this setting, a tone sounds when printing ends. The default setting is `Off`.

1 In the `Buzzer` menu screen, press Δ or ∇ to select `Job Finish`.

2 Press **[OK]**. The `Job Finish` screen appears.

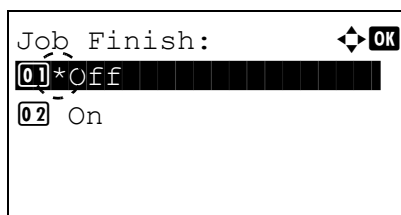

3 Press Δ or ∇ to select whether the printing completed tone is enabled.

- 4 Press **[OK]**. The printing completed tone setting is set and the `Buzzer` menu reappears.

Ready (Preparation completed tone setting)

When `On` is selected in this setting, a tone sounds when print preparation has been completed. The default setting is `Off`.

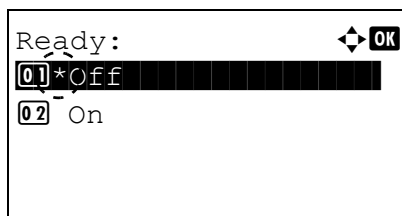

- 1 In the `Buzzer` menu screen, press Δ or ∇ to select `Ready`.
- 2 Press **[OK]**. The `Ready` screen appears.

- 3 Press Δ or ∇ to select whether the preparation completed tone is enabled.
- 4 Press **[OK]**. The preparation completed tone setting is set and the `Buzzer` menu reappears.

Error (Error tone setting)

When `On` is selected in this setting, a tone sounds when a problem such as running out of paper or a paper jam occurs during printing. The default setting is `On`.

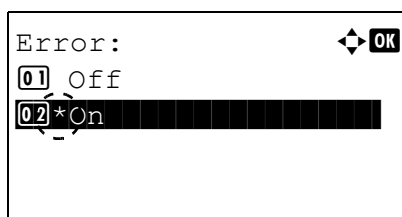

- 1 In the `Buzzer` menu screen, press Δ or ∇ to select `Error`.
- 2 Press **[OK]**. The `Error` screen appears.

- 3 Press Δ or ∇ to select whether the warning tone is enabled.
- 4 Press **[OK]**. The warning tone setting is set and the `Buzzer` menu reappears.

Keyboard Confirm (Keyboard confirmation tone setting)

When `On` is selected in this setting, a tone sounds each time a USB keyboard is used. The default setting is `Off`.

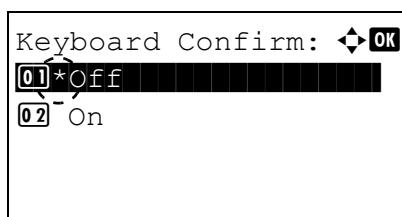

- 1 In the `Buzzer` menu screen, press Δ or ∇ to select `Keyboard Confirm`.
- 2 Press **[OK]**. The `Keyboard Confirm` screen appears.

- 3 Press Δ or ∇ to select whether the keyboard confirmation tone is enabled.

- 4 Press **[OK]**. The Keyboard Confirm tone setting is set and the Buzzer menu reappears.

RAM Disk Setting (Using the RAM disk)

The RAM disk is a memory space shared within the printer memory that can temporarily store print jobs. The stored print job can then be used to print multiple copies of the job reducing the total amount of time required to print the whole job. It acts similar to the SSD except that the data is effective only when the printer is powered up.

To use the RAM disk, activate and enter the desired size of the RAM disk in the manner described below. The maximum RAM disk size can be calculated as follows:

When the RAM disk is activated = The maximum RAM disk size is 16 MB (or 4 MB on FS-2100D) (when no options are attached.)

When the optional memory is installed = The maximum RAM disk size is 1/2 of the total optional memory installed

By default, the RAM disk is set to On.

To activate RAM disk in the printer's memory, first you must set the RAM disk mode to On and set the desired data size for the RAM disk as described in the following section. This allows you to perform the following operations on the RAM disk.

 **Note** The printer supports three types of storage device; SD/SDHC memory card, optional SSD (HD-6), and RAM disk. The SD/SDHC memory card and optional SSD (HD-6) are installed into the dedicated slots of the printer. The RAM disk is an allocated part of the printer's memory.

IMPORTANT The RAM disk can not be used when an optional SSD (HD-6) is installed.

The RAM disk stores data only temporarily. When the printer is reset or turned off, the stored data will be erased.

The RAM disk allows some Job Box functions to be used.

The RAM disk is allocated from the printer memory available to users. If the size of the RAM disk is set too large, the printing speed may decrease or the memory may become insufficient.

The options available in RAM Disk Setting are as follows:

- RAM Disk Mode (Setting the RAM disk)...4-82
- RAM Disk Size (RAM disk size setting)...4-82

- 1 In the Device Common menu, press Δ or ∇ to select RAM Disk Setting.
- 2 Press **[OK]**. The RAM Disk Setting menu screen appears.

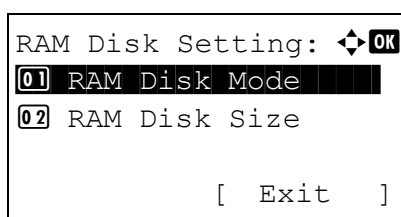

RAM Disk Mode (Setting the RAM disk)

Selecting **On** in this setting enables the RAM disk.

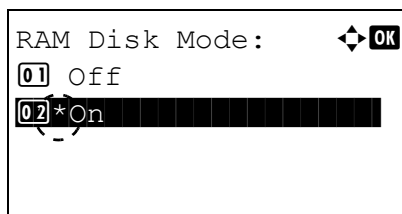

1 In the **RAM Disk Setting** menu, press Δ or ∇ to select **RAM Disk Mode**.

2 Press **[OK]**. The **RAM Disk Mode** screen appears.

3 Press Δ or ∇ to select whether the RAM disk is enabled.

4 Press **[OK]**. The RAM disk setting is set and the **RAM Disk Setting** menu reappears.

RAM Disk Size (RAM disk size setting)

Use this procedure to set the amount of memory used for the RAM disk.

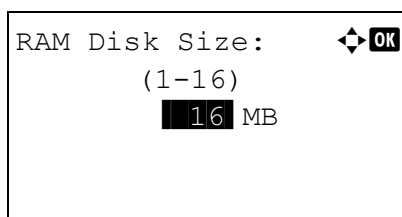

1 In the **RAM Disk Setting** menu, press Δ or ∇ to select **RAM Disk Size**.

2 Press **[OK]**. The **RAM Disk Size** screen appears.

3 Use the numeric keys or press Δ or ∇ to set the amount of memory to be used as a RAM disk.

The maximum amount of memory that can be set varies depending on the total amount of memory in the printer.

4 Press **[OK]**. The amount of memory used as a RAM disk is stored and the **RAM Disk Setting** menu reappears.

When you have completed the setting, exit the menu and restart the printer. The selected setting is valid after the printer starts up again.

Format SSD (Formatting the SSD)

When an optional SSD (HD-6) is inserted into the printer for the first time, it must be formatted before use.

This menu is displayed only when the HD-6 is installed on the printer.

 **Note** If the HD-6 is installed in the printer, the Document Box will be available. Formatting will destroy any existing data on a storage device including a used HD-6. Formatting of the HD-6 must be executed from the printer. When the HD-6 has not yet been formatted, the Attention indicator flashes and **Format SSD** is displayed.

Use the procedure below to format the HD-6.

When a new HD-6 is inserted in the printer's slot, **Format SSD** will appear on the message display.

1 In the **Device Common** menu, press Δ or ∇ to select **Format SSD**.

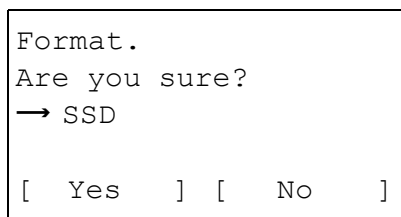

2 Press **[OK]**. A confirmation screen appears.

3 Press **[Yes]** (**[Left Select]**). The `Formatting...` screen appears and SSD formatting begins. Once the formatting ends, the standby screen reappears.

Pressing **[No]** (**[Right Select]**) returns to the `Device Common` menu without formatting the SSD.

Format SD Card (Formatting the SD/SDHC memory card)

The printer is equipped with a slot for an SD/SDHC memory card.

For details about the handling of the SD/SDHC memory card, refer to *Installing and Formatting the SD/SDHC Memory Card* on page A-9.

A new SD/SDHC memory card must be formatted before it can be used in the printer. Formatting allows data to be written to the SD/SDHC memory card.

IMPORTANT `Format SD Card` is only displayed when an SD/SDHC memory card is installed in the printer and protection is disabled.

 **Note** Formatting will destroy any existing data on a storage device including a used SD/SDHC memory card. Formatting of the SD/SDHC memory card must be executed from the printer.

When a new SD/SDHC memory card is inserted in the printer's slot, `Format SD Card` will appear on the message display.

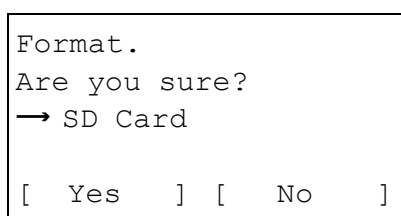

1 In the `Device Common` menu, press Δ or ∇ to select `Format SD Card`.

2 Press **[OK]**. A confirmation screen appears.

3 Press **[Yes]** (**[Left Select]**). The `Formatting SD card...` screen appears and SD/SDHC memory card formatting begins. Once the formatting ends, the standby screen reappears.

Pressing **[No]** (**[Right Select]**) returns to the `Device Common` menu without formatting the SD/SDHC memory card.

Display Bright. (Display brightness setting)

Sets the brightness of the message display.

1 In the `Device Common` menu, press Δ or ∇ to select `Display Bright..`

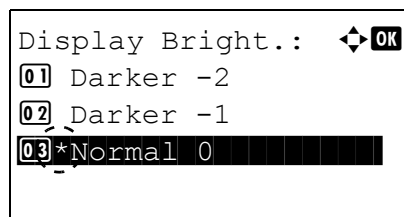

- 2 Press **[OK]**. The `Display Bright.` screen appears showing the available brightness settings.

The list shows the following brightness settings:

Darker -2
Darker -1
Normal 0
Lighter +1
Lighter +2

- 3 Press Δ or ∇ to select the desired brightness.
- 4 Press **[OK]**. The brightness is set and the `Device Common` menu reappears.

Disp. Backlight (Display backlight setting)

Set the backlight for the message display.

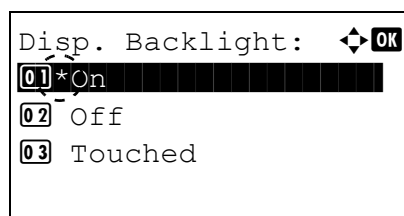

- 1 In the `Device Common` menu, press Δ or ∇ to select `Disp. Backlight`.

- 2 Press **[OK]**. The `Disp. Backlight` screen appears.

The list shows the following display backlight settings:

On (Standard)
Off (No backlight)
Touched (Backlight lights up when the key on the operation panel is pressed)



Note If `Touched` is selected, the backlight turns off again when the panel is reset after the setting time of `Auto Panel Reset` has passed or when **[Logout]** is pressed.

- 3 Press Δ or ∇ to select the desired backlight setting.
- 4 Press **[OK]**. The backlight setting is set and the `Device Common` menu reappears.

Error Handling (Error detection setting)

This specifies the settings for the detection methods used for duplex printing errors and for paper size and paper type errors when the paper source is fixed.

The options available in Error Handling are as follows:

- DuplexPaperError (Duplex printing error detection setting)...4-85
- Paper Mismatch (Detection settings for paper size/type errors when the paper source is fixed)...4-85
- MP Tray Empty (Warning when the MP tray is empty)...4-85

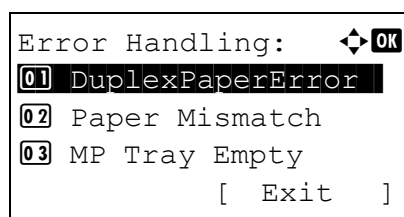

- 1 In the `Device Common` menu, press Δ or ∇ to select `Error Handling`.

- 2 Press **[OK]**. The `Error Handling` menu screen appears.

DuplexPaperError (Duplex printing error detection setting)

If the error detection setting for duplex printing has been turned `Display Error`, and you attempt to print onto a paper size and paper type that cannot be used for duplex printing, the `Duplex disabled` error message will be displayed and printing will stop.

Display Error	<ul style="list-style-type: none"> To print onto one-side of the paper only when this message is displayed, press [OK]. Press [Cancel] to cancel the printing itself.
1-sided	<ul style="list-style-type: none"> To print onto one-side of the paper.

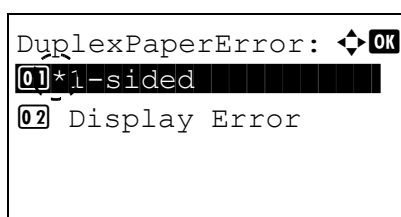

- 1 In the `Error Handling` menu, press Δ or ∇ to select `DuplexPaperError`.
- 2 Press **[OK]**. The `DuplexPaperError` screen appears.

- 3 Press Δ or ∇ to select the setting for handling duplex paper errors.
- 4 Press **[OK]**. The handling of duplex paper errors is set and the `Error Handling` menu screen reappears.

Paper Mismatch (Detection settings for paper size/type errors when the paper source is fixed)

Select `Continue` in this setting if you want to continue printing even if the paper size or type you specified is different from the fixed paper source, or select `Display Error` to have the paper feed error displayed.

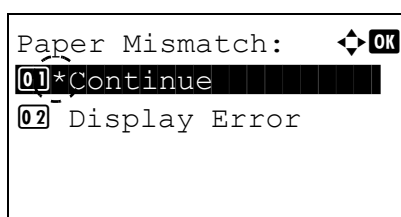

- 1 In the `Error Handling` menu, press Δ or ∇ to select `Paper Mismatch`.
- 2 Press **[OK]**. The `Paper Mismatch` screen appears.

- 3 Press Δ or ∇ to select the setting for handling paper mismatch errors.
- 4 Press **[OK]**. The handling of paper mismatch errors is set and the `Error Handling` menu screen reappears.

MP Tray Empty (Warning when the MP tray is empty)

Turn this setting to `On` if you want the error displayed when the MP tray is configured as the default paper source, and there is no paper in the MP tray, or turn it to `Off` not to have the error displayed.

The setting `On` enables the paper-empty message to display when the MP tray is empty.

- 1 In the `Error Handling` menu, press Δ or ∇ to select `MP Tray Empty`.

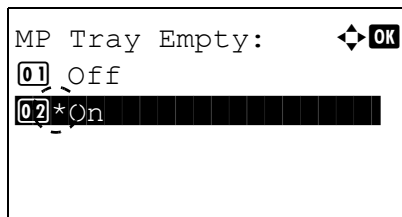

2 Press **[OK]**. The MP Tray Empty screen appears.

3 Press Δ or ∇ to select the setting for the paper-empty message to display.

4 Press **[OK]**. The display of MP Tray Empty is set and the Error Handling menu screen reappears.

Timer Setting

This specifies timer-related settings such as the automatic form-feed timeout and the timeout settings for Auto Sleep.

IMPORTANT To change the Timer Setting, the administrator's Login User Name and Login Password must be entered. For details of the administrator settings, refer to *Administrator on page 4-116*.

The options available in Timer Setting are as follows:

- Auto Panel Reset (Auto panel reset setting)...4-87
- PanelReset Timer (Setting the panel reset timer)...4-88
- Sleep Level Set. (Sleep level setting)...4-88
- Sleep Timer (Sleep timer timeout time)...4-90
- Power Off Rule (Power Off Rule setting)...4-90
- Power Off Timer (Power off timer settings)...4-91
- Auto Err. Clear (Auto error clear setting)...4-91
- Err. Clear Timer (Setting the error clear time)...4-92
- FormFeed TimeOut (Automatic form feed timeout setting)...4-92

1 In the Device Common menu, press Δ or ∇ to select Timer Setting.

2 Press **[OK]**. The Login screen appears.



Note When user login administration is set:

- When logged in as an administrator, the log in screen is not displayed and the Timer Setting menu screen is displayed.
- The setting is not possible when logged in as anyone other than an administrator. Log in again as an administrator.

3 With the Login User Name entry field selected, press **[OK]**. The Login User Name entry screen is displayed.

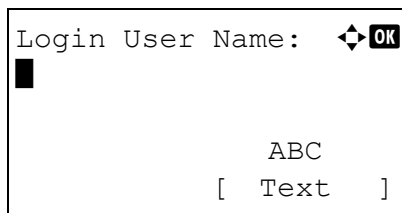
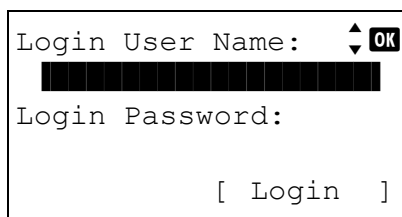

4 Enter the Login User Name using the numeric keys then press **[OK]**. The log in screen reappears.



Note The initial setting for the administrator's Login User Name is "Admin".

For details on entering characters, refer to *Character Entry Method on page A-2*.

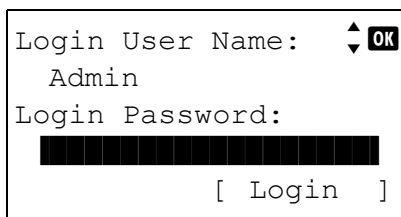

5 Press Δ or ∇ to select the Login Password entry field.

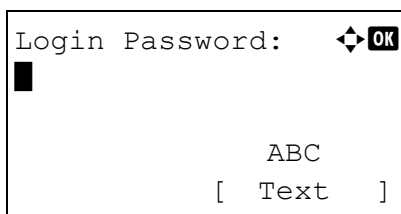

6 Press [OK]. The Login Password entry screen is displayed.

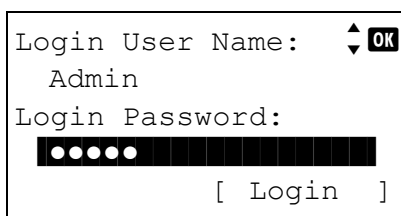

7 Enter the Login Password using the numeric keys then press [OK]. The login screen reappears.



Note The initial setting for the administrator's Login Password is "Admin".

For details on entering characters, refer to *Character Entry Method* on page A-2.

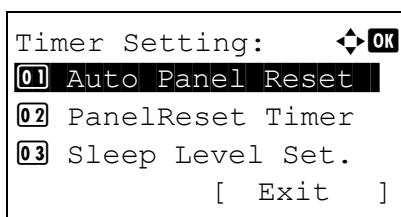

8 Pressing [Login] ([Right Select]). If the entered Login User Name and Login Password are correct, the Timer Setting menu appears showing a list of available options.

Auto Panel Reset (Auto panel reset setting)

The Auto Panel Reset function automatically restores the default settings if the panel is not used for a set time. The default setting is On.

For setting the time until the panel is automatically reset, refer to *PanelReset Timer (Setting the panel reset timer)* on page 4-88.

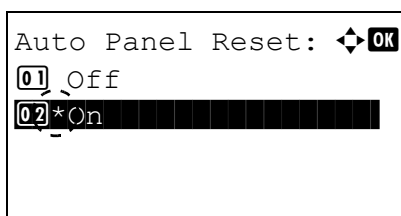

1 In the Timer Setting menu, press Δ or ∇ to select Auto Panel Reset.

2 Press [OK]. The Auto Panel Reset screen appears.

3 Press Δ or ∇ to select whether Auto Panel Reset is enabled.

4 Press [OK]. The Auto Panel Reset setting is set and the Timer Setting menu reappears.

PanelReset Timer (Setting the panel reset timer)

When `Auto Panel Reset` is set to `On`, this sets the time until the panel is automatically reset after the user stops using the panel. The default setting is 90 seconds.

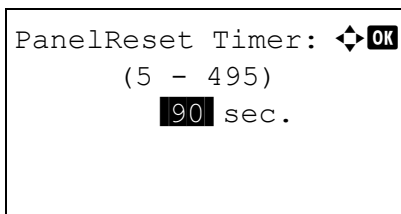

- 1 In the `Timer Setting` menu, press Δ or ∇ to select `PanelReset Timer`.
- 2 Press **[OK]**. The `PanelReset Timer` screen appears.
- 3 Use the numeric keys or press Δ or ∇ to set the panel reset time.
- 4 Press **[OK]**. The panel reset time setting is stored and the `Timer Setting` menu reappears.

Sleep Level Set. (Sleep level setting)

There are two sleep modes with different levels of sleep: `Quick Recovery` and `Energy Saver`.

Quick Recovery Mode: The recovery from the sleep mode is faster than when using `Energy Saver` mode.

Energy Saver Mode: This makes it possible to reduce energy consumption even further than with `Quick Recovery` mode. With `Energy Saver` mode, you can set whether to enable the `Energy Saver` mode for each separate function.

 **Note** For information on the `Quick Recovery` mode and `Energy Saver` mode, refer to *Energy Saver Function* on page 2-21.

`Sleep Level Set.` menu is not displayed when the optional network interface kit (IB-50) or wireless network interface kit (IB-51) has been installed.

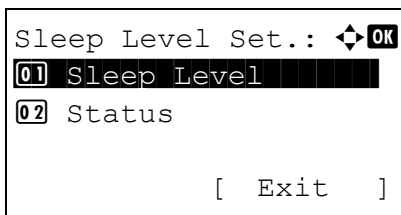
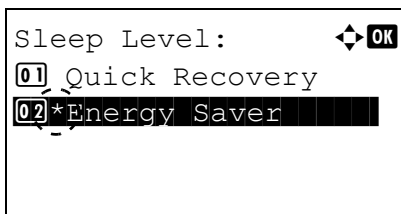
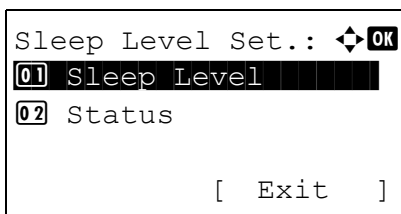

- 1 In the `Timer Setting` menu, press Δ or ∇ to select `Sleep Level Set.`
- 2 Press **[OK]**. The `Sleep Level Set.` menu screen appears.
- 3 Press Δ or ∇ to select `Sleep Level`.
- 4 Press **[OK]**. The `Sleep Level` screen appears.
- 5 Press Δ or ∇ to select `Quick Recovery` or `Energy Saver`.
- 6 Press **[OK]**. The sleep level is set and the `Sleep Level Set.` menu reappears.
When `Energy Saver` is set, next go on to set whether or not to use `Energy Saver` mode for each function.

7 Press Δ or ∇ to select *Status*.

 **Note** *Status* is only displayed when *Energy Saver* is set.

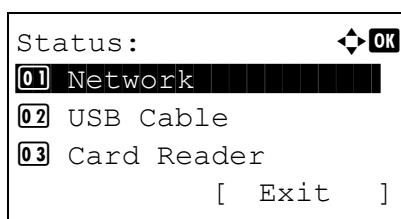

8 Press **[OK]**. The *Status* menu screen appears.

Next set whether or not to use *Energy Saver* mode for each function.

Item	Default Value
Network (Network interface setting)	On
USB Cable (USB interface setting)	On
Card Reader (ID card reader setting)	On
RAM Disk (RAM Disk Mode setting)	Off
Parallel Cable (Parallel interface setting)	On

 **Note** *Network* and *RAM Disk* are only displayed on network compatible models.

Card Reader is only displayed when the ID card reader function has been activated.

Parallel Cable is only displayed when the optional parallel interface kit (IB-32) has been installed.

9 Press Δ or ∇ to select which function to set.

10 Press **[OK]**. The screen for the function selected is displayed.

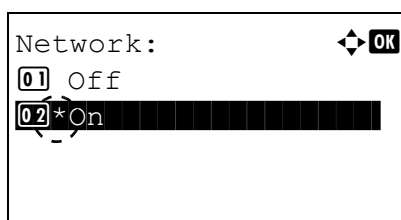

11 Press Δ or ∇ to select whether or not to use *Energy Saver* mode. Select *On* to set the *Energy Saver* mode.

12 Press **[OK]**. Set the *Energy Saver* mode for each function and *Status* menu reappears.

 **Note** Repeat steps 9 to 12 to set *Energy Saver* mode for a different function.

Sleep Timer (Sleep timer timeout time)

You can adjust the length of time the printer waits before entering Auto Sleep in the absence of data. The printer reverts to normal operation mode when the printer receives a print job, **[OK]** is pressed or one of the exterior covers is opened. The default time is 1 minute.

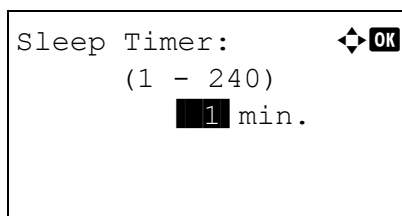

- 1 In the `Timer Setting` menu, press Δ or ∇ to select `Sleep Timer`.
- 2 Press **[OK]**. The `Sleep Timer` screen appears.
- 3 Use the numeric keys or Δ or ∇ to set the sleep time.
- 4 Press **[OK]**. The sleep time setting is stored and the `Timer Setting` menu reappears.

Power Off Rule (Power Off Rule setting)

The Power Off Rule is used to stop the power from automatically turning off when the machine is in certain states or certain settings are in effect. Rules that can be set and their initial settings are as follows:

Item	Default Value		
	FS-2100D		FS-2100DN/FS-4100DN/ FS-4200DN/FS-4300DN
	For EU countries [†]	Other than EU countries	
Network (Network interface setting)	–	–	Off
USB Cable (USB interface setting)	On	Off	Off
USB Host (USB memory slot setting)	On	Off	Off
RAM Disk (RAM Disk Mode setting) ^{††}	Off	Off	Off
NIC (Option Network interface kit (NIC) setting)	Off	Off	Off
Parallel I/F (Parallel interface setting)	On	Off	Off

[†] The default value is not displayed and customized.

^{††} If the Power Off Rule is previously set to `On`, the machine turns off the power and all the data stored in the RAM Disk is deleted.

 **Note** When `On` is set it automatically turns off.

`Network` is only displayed on network compatible models.

`NIC` is only displayed when the optional network interface kit (IB-50) or wireless network interface kit (IB-51) has been installed.

`Parallel I/F` is only displayed when the optional parallel interface kit (IB-32) has been installed.

- 1 In the `Timer Setting` menu, press Δ or ∇ to select `Power Off Rule`.
- 2 Press **[OK]**. The `Power Off Rule` menu screen appears.

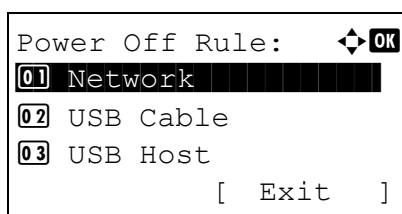

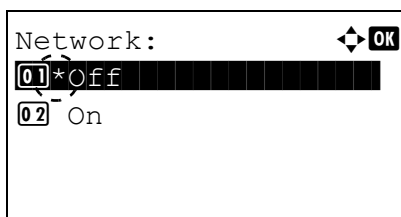

- 3 Press Δ or ∇ to select the condition to be set.
- 4 Press **[OK]**. The screen for the condition selected is displayed.

- 5 Press Δ or ∇ to select whether or not to have the power switch off.
- 6 Press **[OK]**. Set to switch the power off and the `Power Off Rule` menu reappears.



Note Repeat steps 3 to 6 to set for a different condition.

Power Off Timer (Power off timer settings)

The time until the power turns off can be set. The default setting is 1 hour.

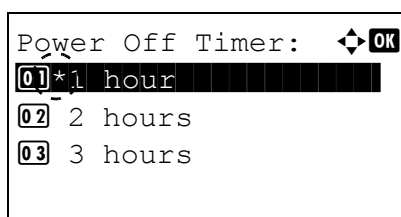

- 1 In the `Timer Setting` menu, press Δ or ∇ to select `Power Off Timer`.
- 2 Press **[OK]**. The `Power Off Timer` screen appears.

- 3 Press Δ or ∇ to select the time until the power goes off automatically. The times that can be set are 1 hour, 2 hours, 3 hours, 4 hours, 5 hours, 6 hours, 9 hours, 12 hours, 1 day, 2 days, 3 days, 4 days, 5 days, 6 days and 1 week.
- 4 Press **[OK]**. Set the time until the power switches off and the `Timer Setting` menu reappears.

Auto Err. Clear (Auto error clear setting)

If an error that still allows you to continue printing occurs, the next received data is automatically printed after a set period of time elapses.

For example, if the printer is shared over a network as a network printer and one person causes one of the above errors, after the set period of time elapses, the data sent from the next person is printed. The default setting is `Off` (Auto Error Clear disabled).

The auto clear errors are:

Print overrun.

KPDL error.

SSD error.

RAM disk error.

SD card error.

Incorrect account ID.

Account error.

Cannot duplex print on this paper.
 Job Accounting restriction exceeded.
 No multi copies.
 USB memory error.
 Restricted by Job Accounting.
 Job not stored.

For the procedure for setting the automatic error recovery time, refer to *Err. Clear Timer (Setting the error clear time)* on page 4-92.

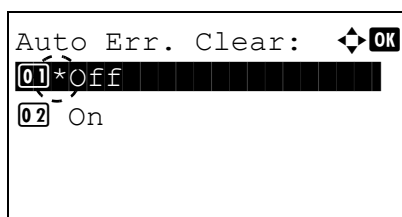

- 1** In the `Timer Setting` menu, press Δ or ∇ to select `Auto Err. Clear`.
- 2** Press **[OK]**. The `Auto Err. Clear` screen appears.

- 3** Press Δ or ∇ to select whether automatic error recovery is enabled.
- 4** Press **[OK]**. The automatic error recovery setting is set and the `Timer Setting` menu reappears.

Err. Clear Timer (Setting the error clear time)

If `Auto Err. Clear` is set to `On` and a non-fatal error (an error that allows printing to continue) occurs, this setting specifies the time until the error is recovered and printing resumes. The default setting is 30 seconds.

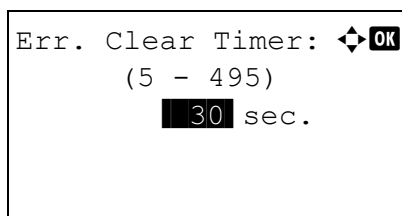

- 1** In the `Timer Setting` menu, press Δ or ∇ to select `Err. Clear Timer`.
- 2** Press **[OK]**. The `Err. Clear Timer` screen appears.

- 3** Use the numeric keys or press Δ or ∇ to set the recovery time.
- 4** Press **[OK]**. The recovery time setting is stored and the `Timer Setting` menu reappears.

FormFeed TimeOut (Automatic form feed timeout setting)

Receiving print data from the computer, the machine may sometimes wait if there is no information signalling that the last page does not have any more data to be printed. When the preset timeout passes, the machine automatically prints paper.. The default setting is 30 seconds.

- 1** In the `Timer Setting` menu, press Δ or ∇ to select `FormFeed TimeOut`.

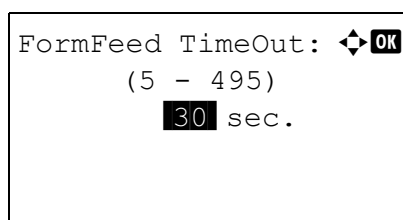

- 2** Press **[OK]**. The `FormFeed TimeOut` screen appears.
- 3** Use the numeric keys or press Δ or ∇ to set the form feed timeout delay.
- 4** Press **[OK]**. The form feed timeout setting is stored and the `Timer Setting` menu reappears.

USB KeyboardType (USB keyboard type selection)

Select the type of USB keyboard that you want to use.

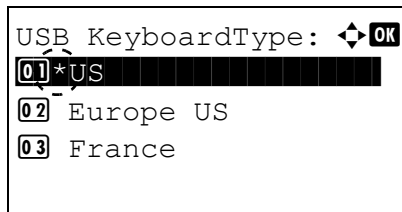

- 1 In the `Device Common` menu, press Δ or ∇ to select `USB KeyboardType`.
- 2 Press **[OK]**. The `USB KeyboardType` screen appears. The available USB keyboard types are as follows:
`US`
`Europe US`
`France`
`Germany`
- 3 Press Δ or ∇ to select the desired USB keyboard type.
- 4 Press **[OK]**. The USB keyboard type is set and the `Device Common` menu reappears.

TonerAlert Level (Setting for the alert level for toner addition)

This sets the toner addition alert level displayed on the status monitor.

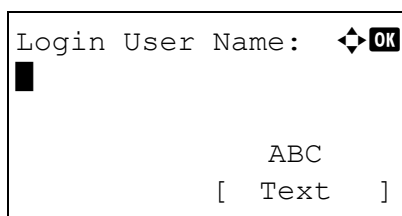
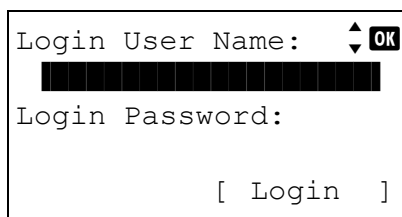

- 1 In the `Device Common` menu, press Δ or ∇ to select `TonerAlert Level`.
- 2 Press **[OK]**. The Login screen appears.
 -  **Note** When user login administration is set:
 - When logged in as an administrator, the log in screen is not displayed and the `TonerAlert Level` menu screen is displayed.
 - The setting is not possible when logged in as anyone other than an administrator. Log in again as an administrator.
- 3 With the `Login User Name` entry field selected, press **[OK]**. The `Login User Name` entry screen is displayed.

- 4 Enter the `Login User Name` using the numeric keys then press **[OK]**. The log in screen reappears.



Note The initial setting for the administrator's `Login User Name` is "Admin".

For details on entering characters, refer to *Character Entry Method* on page A-2.

- 5 Press Δ or ∇ to select the `Login Password` entry field.

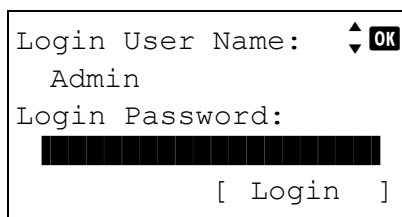

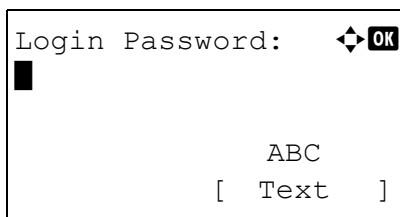

6 Press **[OK]**. The `Login Password` entry screen is displayed.

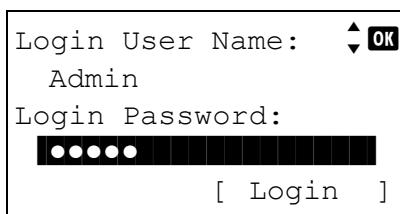

7 Enter the `Login Password` using the numeric keys then press **[OK]**. The login screen reappears.



Note The initial setting for the administrator's `Login Password` is "Admin".

For details on entering characters, refer to *Character Entry Method* on page A-2.

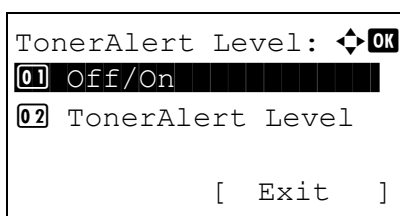

8 Pressing `[Login]` (**[Right Select]**). If the entered `Login User Name` and `Login Password` are correct, the `TonerAlert Level` menu screen appears.

9 Press Δ or ∇ to select `Off/On`.

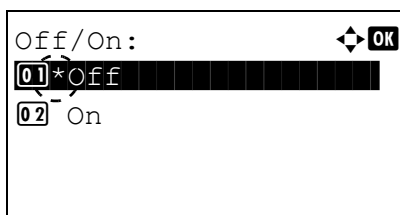

10 Press **[OK]**. The `Off/On` screen appears.

11 Press Δ or ∇ to select whether `Toner Alert Level` is enabled.

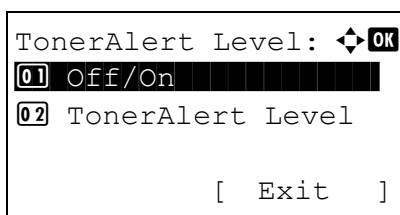

12 Press **[OK]**. The `TonerAlert Level` screen appears.

13 Press Δ or ∇ to select `TonerAlert Level`.

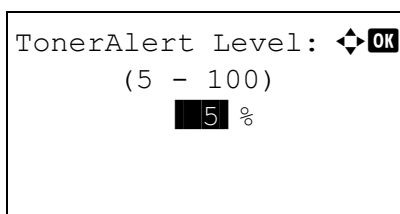

14 Press **[OK]**. The `TonerAlert Level` screen appears.

15 Use the numeric keys or press Δ or ∇ to set the level at which an alert will be displayed. The setting is possible between 5 and 100%.

16 Press **[OK]**. The `Toner Alert Level` is set and the `TonerAlert Level` menu reappears.

Security (Security function setting)

The security functions can be set up to protect printer operation and the print data.

IMPORTANT To change the Security function settings, the administrator's Login User Name and Login Password must be entered. For details of the administrator settings, refer to *Administrator on page 4-116*.

The options available in Security are as follows:

- Network Security (Network security setting)...4-97
- I/F Block Set. (External interface block setting)...4-103
- Security Level...4-105
- Data Security (Data Security setting)...4-106

 **Note** The `Data Security` menu is used with the optional Data Security Kit (E). For details, refer to *Data Security Kit (E) Operation Guide*.

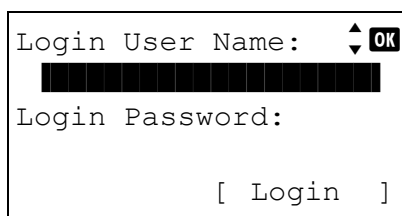
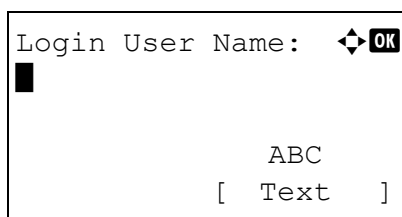
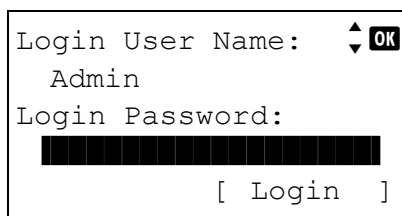
- 1 Press **[MENU]**.
- 2 Press Δ or ∇ to select `Security`.
- 3 Press **[OK]**. The Login screen appears.



Note When user login administration is set:

- When logged in as an administrator, the log in screen is not displayed and the `Security` menu screen is displayed.
- The setting is not possible when logged in as anyone other than an administrator. Log in again as an administrator.

- 4 With the `Login User Name` entry field selected, press **[OK]**. The `Login User Name` entry screen is displayed.

- 5 Enter the Login User Name using the numeric keys then press **[OK]**. The log in screen reappears.



Note The initial setting for the administrator's Login User Name is "Admin".

For details on entering characters, refer to *Character Entry Method on page A-2*.

- 6 Press Δ or ∇ to select the `Login Password` entry field.

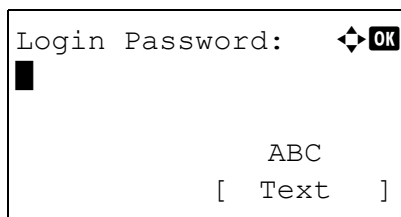

7 Press **[OK]**. The Login Password entry screen is displayed.

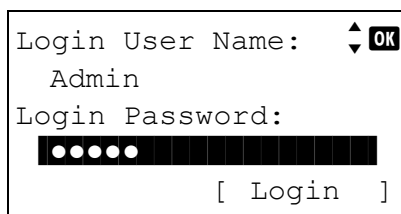

8 Enter the Login Password using the numeric keys then press **[OK]**. The log in screen reappears.



Note The initial setting for the administrator's Login Password is "Admin".

For details on entering characters, refer to *Character Entry Method* on page A-2.

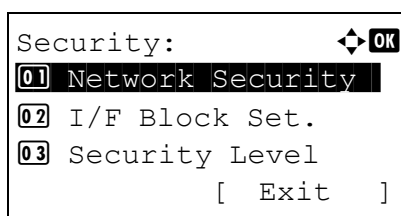

9 Pressing **[Login]** (**[Right Select]**). If the entered Login User Name and Login Password are correct, the Security menu screen appears.

Network Security (Network security setting)

Use this procedure to specify the security settings for each of the network protocols used.

IMPORTANT Check with your network administrator when selecting network settings.

The options available in Network Security are as follows:

- WSD-PRINT (WSD-PRINT setting)...4-98
- Enhanced WSD (Enhanced WSD setting)...4-98
- EnhancedWSD(SSL) (Enhanced WSD (SSL) setting)...4-98
- IPP (IPP setting)...4-99
- SSL Setting (SSL Server setting)...4-99
- IPSec (IPSec setting)...4-102
- ThinPrint (Thin Print setting)...4-102
- LAN Interface (LAN Interface setting)...4-103

1 In the Security menu, press Δ or ∇ to select Network Security.

2 Press **[OK]**. The Network Security menu screen appears.

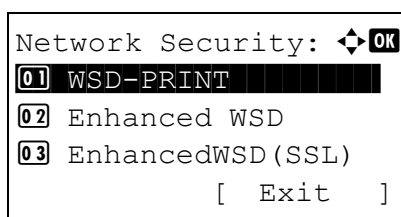

WSD-PRINT (WSD-PRINT setting)

Select whether or not to use WSD Print. The default setting is On.

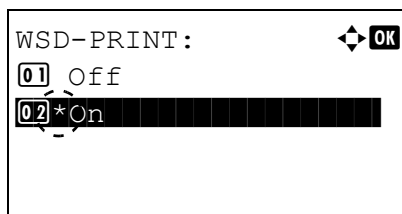

1 In the *Network Security* menu, press Δ or ∇ to select WSD-PRINT.

2 Press **[OK]**. The WSD-PRINT screen appears.

3 Press Δ or ∇ to select whether WSD-PRINT is enabled.

4 Press **[OK]**. The WSD-PRINT setting is set and the *Network Security* menu reappears.

Enhanced WSD (Enhanced WSD setting)

Set whether to use our proprietary web services. Network driver use this Enhanced WSD Web service. The default setting is On.

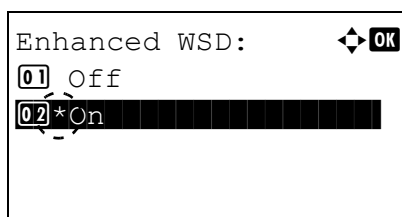

1 In the *Network Security* menu, press Δ or ∇ to select Enhanced WSD.

2 Press **[OK]**. The Enhanced WSD screen appears.

3 Press Δ or ∇ to select whether Enhanced WSD is enabled.

4 Press **[OK]**. The Enhanced WSD setting is set and the *Network Security* menu reappears.

EnhancedWSD(SSL) (Enhanced WSD (SSL) setting)

Set whether to use our proprietary web services over SSL. SSL must be set to On in *SSL (SSL Server setting)* on page 4-99. The default setting is On.

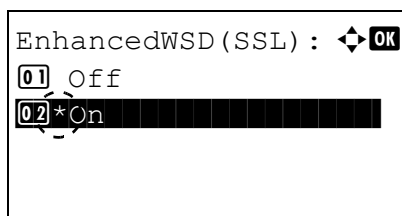

1 In the *Network Security* menu, press Δ or ∇ to select EnhancedWSD(SSL).

2 Press **[OK]**. The EnhancedWSD(SSL) screen appears.

3 Press Δ or ∇ to select whether Enhanced WSD (SSL) is enabled.

4 Press **[OK]**. The Enhanced WSD (SSL) setting is set and the *Network Security* menu reappears.

IPP (IPP setting)

IPP (Internet Printing Protocol) is a standard that uses TCP/IP networks such as the Internet to enable print jobs to be sent between remote computers and printers.

IPP is an extension of the HTTP protocol used to view websites and enables printing to be carried out via routers on printers in remote locations. It also supports the HTTP authentication mechanisms along with SSL server and client authentication as well as encryption. The default setting is `Off`.

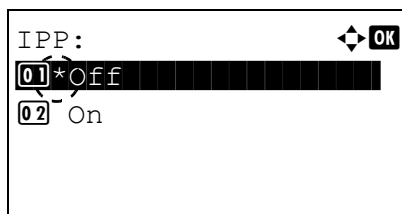

- 1 In the `Network Security` menu, press Δ or ∇ to select `IPP`.
- 2 Press **[OK]**. The `IPP` screen appears.

- 3 Press Δ or ∇ to select whether `IPP` is enabled.
- 4 Press **[OK]**. The `IPP` setting is set and the `Network Security` menu reappears.

SSL Setting (SSL Server setting)

SSL (Secure Sockets Layer) refers to a protocol used to encrypt information sent and received over a network. SSL can currently be used to encrypt data such as the WWW or FTP files widely used on the Internet so that privacy-related information, credit card numbers, corporate secrets and other confidential information can be sent and received safely.

SSL servers use this protocol to authenticate servers and clients.

The options available in `SSL Setting` are as follows:

- `SSL (SSL Server setting)`...4-99
- `IPP over SSL (SSL Server IPP over SSL setting)`...4-101
- `HTTPS (SSL Server HTTPS setting)`...4-101

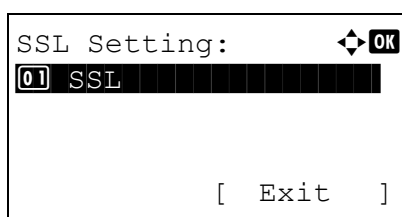

- 1 In the `Network Security` menu, press Δ or ∇ to select `SSL Setting`.
- 2 Press **[OK]**. The `SSL Setting` menu screen appears.

SSL (SSL Server setting)

Select the `SSL` server settings.

The options available in `SSL` are as follows:

- `Off/On (SSL operation setting)`...4-100
- `Encryption (Encryption setting)`...4-100

- 1 In the `SSL Setting` menu, press Δ or ∇ to select `SSL`.

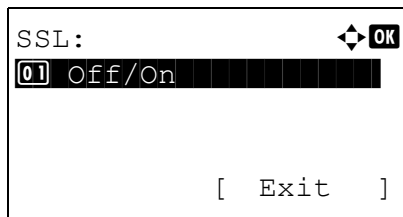

2 Press **[OK]**. The SSL menu screen appears.

Off/On (SSL operation setting)

Select whether or not to use the SSL server. The default setting is *Off*.

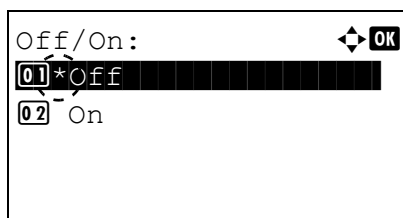

- 1** In the SSL menu, press Δ or ∇ to select *Off/On*.
- 2** Press **[OK]**. The *Off/On* screen appears.

- 3** Press Δ or ∇ to select whether to use the SSL server.
- 4** Press **[OK]**. The SSL server setting is set and the SSL menu reappears.

Encryption (Encryption setting)

Select the encryption method used on the SSL server.

 **Note** This setting is only displayed when the *SSL Setting (SSL Server setting)* on page 4-99 is set to *On*.

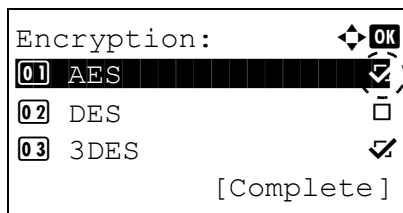

- 1** In the SSL menu, press Δ or ∇ to select *Encryption*.
- 2** Press **[OK]**. The *Encryption* screen appears.

3 Press Δ or ∇ to select the encryption method to be used and then press **[OK]**.

The options available in *Encryption* are as follows:

- **AES (SSL Server AES setting)**
 AES (Advanced Encryption Standard) was developed to replace DES as the standard encryption as the safety of DES has declined. AES is a block encryption system that uses 128-bit blocks and an SPN structure (a typical structure for repeated encryption) with three selectable key lengths of 128, 192 and 256 bits.

- DES
DES (Data Encryption Standard) is a typical symmetric-key cryptographic algorithm that divides data in to 64-bit blocks and then encrypts each block using a 56-bit key.

IMPORTANT Symmetric-key cryptography, because it uses the same key for both encryption and decryption, uses the same key in both directions when encrypted data is exchanged. Accordingly, to prevent the key from being divulged, key transfer and storage must be very strictly managed.

- 3DES
3DES (Triple Data Encryption Standard) is a high level of encryption in which DES encryption is repeated threefold.

A hash symbol (✓) appears to the right of the selected encryption method.

- 4 After completing the selection, press [Complete] ([Right Select]). The selected encryption method is set and the SSL menu reappears.

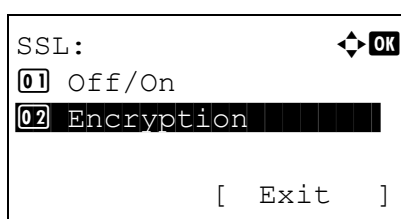

IPP over SSL (SSL Server IPP over SSL setting)

IPP over SSL is an encryption function that uses SSL for communications between users and servers in network printing. To use IPP over SSL, both server and client must support the protocol. The default setting is Off.

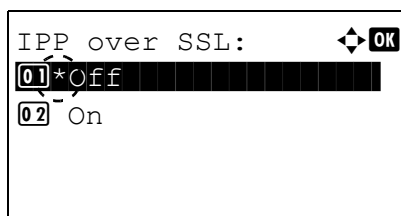

- 1 In the SSL Setting menu, press Δ or ∇ to select IPP over SSL.
- 2 Press [OK]. The IPP over SSL screen appears.

- 3 Press Δ or ∇ to select whether IPP over SSL is enabled.
- 4 Press [OK]. The IPP over SSL setting is set and the SSL Setting menu reappears.

HTTPS (SSL Server HTTPS setting)

HTTPS (HyperText Transfer Protocol Secure) is a protocol that adds SSL data encryption, message authentication and a digital signature function to the HTTP protocol used for data transfer between WWW servers and clients.

S-HTTP is a similar protocol, but HTTPS differs in that it uses SSL. The default setting is On.

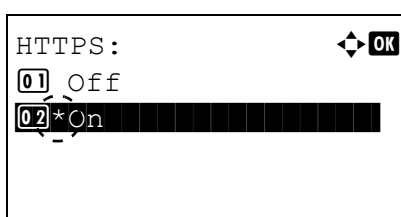

- 1 In the SSL Setting menu, press Δ or ∇ to select HTTPS.
- 2 Press [OK]. The HTTPS screen appears.

- 3 Press Δ or ∇ to select whether HTTPS is enabled.
- 4 Press **[OK]**. The HTTPS setting is set and the *SSL Setting* menu reappears.

IPSec (IPSec setting)

IPSec (IP Security Protocol) is a security protocol adopted as the standard by the IETF for authentication and encryption in the third network layer (IP layer).

It can be used with both IPv4 and IPv6.

 **Note** IPv4 uses 32-bit IP addresses and IPv6 uses 128-bit IP addresses.

The default setting is *Off*.

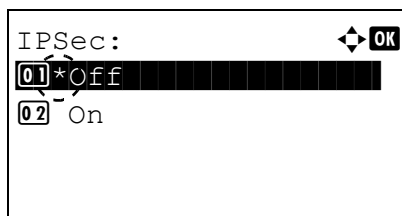

- 1 In the *Network Security* menu, press Δ or ∇ to select IPSec.
- 2 Press **[OK]**. The IPSec screen appears.

- 3 Press Δ or ∇ to select whether IPSec is enabled.
- 4 Press **[OK]**. The IPSec setting is set and the *Network Security* menu reappears.

ThinPrint (Thin Print setting)

Select whether or not to communicate using ThinPrint. SSL settings can also be selected. The default setting is *On*.

 **Note** *Thin Print* is only displayed when the optional UG-33 has been activated.

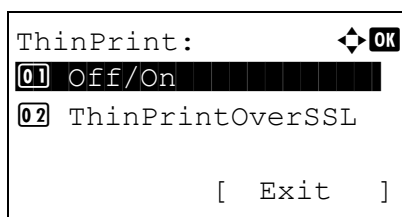

- 1 In the *Network Security* menu, press Δ or ∇ to select ThinPrint.
- 2 Press **[OK]**. The ThinPrint menu screen appears.

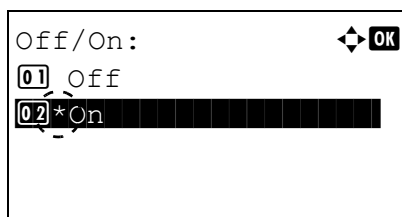

- 3 Press Δ or ∇ to select *Off/On*.
- 4 Press **[OK]**. The *Off/On* screen appears.

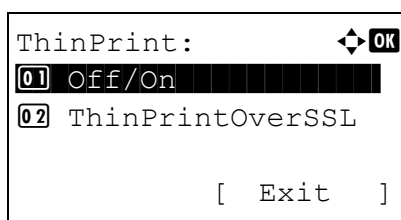

5 Press Δ or ∇ to select whether Thin Print is enabled.

6 Press **[OK]**. The Thin Print is set and the `ThinPrint` menu reappears.

When Thin Print is set to `On`, the settings for Thin Print over SSL are displayed, so continue on and set these.

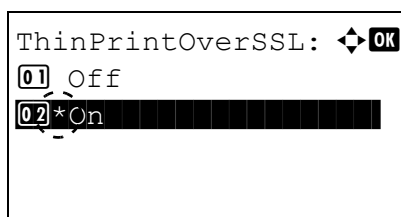

7 Press Δ or ∇ to select `ThinPrintOverSSL`.

8 Press **[OK]**. The `ThinPrintOverSSL` screen appears.

9 Press Δ or ∇ to select whether Thin Print over SSL is enabled.

10 Press **[OK]**. The Thin Print is set and the `ThinPrint` menu reappears.

LAN Interface (LAN Interface setting)

Specify the settings for the LAN interface to be used. The default setting is `Auto`.

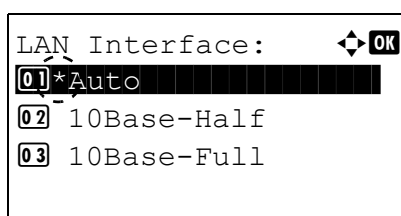

1 In the Network Security menu, press Δ or ∇ to select LAN Interface.

2 Press **[OK]**. The `LAN Interface` screen appears.

The available LAN Interfaces are as follows:

- Auto
- 10Base-Half
- 10Base-Full
- 100Base-Half
- 100Base-Full
- 1000Base-T

3 Press Δ or ∇ to select the desired LAN Interface.

4 Press **[OK]**. The LAN Interface is set and the `Network Security` menu reappears.

I/F Block Set. (External interface block setting)

You can use this to block and thereby protect the interface.

The options available in I/F Block Set. are as follows:

- USB Host (USB Port setting)...4-104
- USB Device (USB interface setting)...4-104
- Option I/F (Optional network interface setting)...4-104
- Parallel I/F (Parallel interface setting)...4-105
- USB Storage (USB memory setting)...4-105

1 In the `Security` menu, press Δ or ∇ to select `I/F Block Set.`

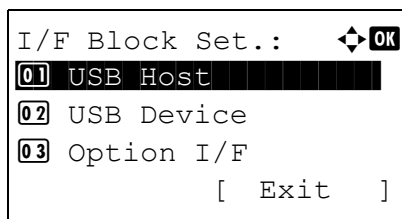

2 Press **[OK]**. The I/F Block Set. menu screen appears.

USB Host (USB Port setting)

This blocks and protects the USB Port (USB Host). The default setting is Unblock.

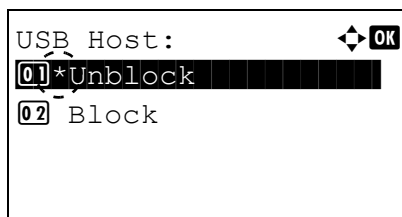

- 1** In the I/F Block Set. menu, press Δ or ∇ to select USB Host.
- 2** Press **[OK]**. The USB Host screen appears.

- 3** Press Δ or ∇ to select whether to block and protect the USB host.
- 4** Press **[OK]**. The USB Host setting is set and the I/F Block Set. menu reappears.

USB Device (USB interface setting)

This blocks and protects the USB interface. The default setting is Unblock.

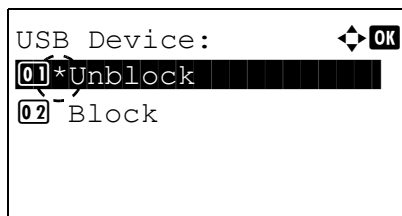

- 1** In the I/F Block Set. menu, press Δ or ∇ to select USB Device.
- 2** Press **[OK]**. The USB Device screen appears.

- 3** Press Δ or ∇ to select whether to block and protect the USB device.
- 4** Press **[OK]**. The USB Device setting is set and the I/F Block Set. menu reappears.

Option I/F (Optional network interface setting)

This blocks and protects the optional network interface. The default setting is Unblock.

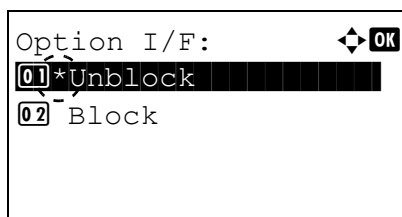

- 1** In the I/F Block Set. menu, press Δ or ∇ to select Option I/F.
- 2** Press **[OK]**. The Option I/F screen appears.

- 3 Press Δ or ∇ to select whether to block and protect the optional network interface.
- 4 Press **[OK]**. The Optional I/F setting is set and the I/F Block Set. menu reappears.

Parallel I/F (Parallel interface setting)

This blocks and protects the parallel interface. The default setting is Unblock.

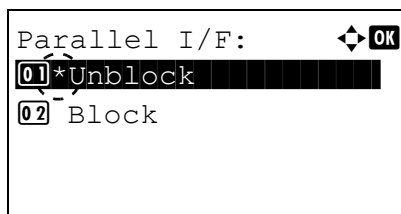

- 1 In the I/F Block Set. menu, press Δ or ∇ to select Parallel I/F.
- 2 Press **[OK]**. The Parallel I/F screen appears.

- 3 Press Δ or ∇ to select whether to block and protect the optional parallel interface.
- 4 Press **[OK]**. The Parallel I/F setting is set and the I/F Block Set. menu reappears.

USB Storage (USB memory setting)

This blocks and protects the USB storage (USB memory). The default setting is Unblock.

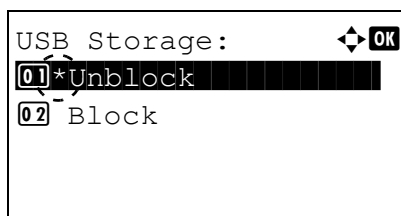

- 1 In the I/F Block Set. menu, press Δ or ∇ to select USB Storage.
- 2 Press **[OK]**. The USB Storage screen appears.

- 3 Press Δ or ∇ to select whether to block and protect the USB memory.
- 4 Press **[OK]**. The USB memory setting is set and the I/F Block Set. menu reappears.

Security Level

The Security Level setting is primarily a menu option used by service personnel for maintenance work. There is no need for customers to use this menu.

Data Security (Data Security setting)

This is to change the Security Password, initialize on optional SSD (HD-6) and sanitizing the stored data.

- SSD Initializ. (SSD Initialization setting)...4-106
- DataSanitization (Sanitizing the stored data)...4-108

 **Note** SSD Initializ. is displayed only when the optional Data Security Kit is installed on the printer.

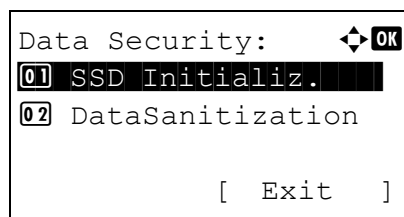

- 1 In the Security menu, press Δ or ∇ to select Data Security.
- 2 Press [OK]. The Data Security menu screen appears.

SSD Initializ. (SSD Initialization setting)

This is to change the Security Password and initialize on optional SSD (HD-6).

- SecurityPassword (Change the Security Password)...4-107
- Initialization (Initialize on optional SSD)...4-107

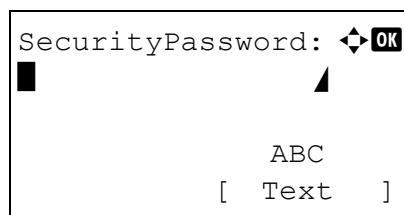

- 1 In the Data Security menu, press Δ or ∇ to select SSD Initializ..
- 2 Press [OK]. The SecurityPassword entry screen appears.

- 3 Enter the Security Password using the numeric keys.

 **Note** The initial setting for the Security Password is "000000". For details on entering characters, refer to *Character Entry Method* on page A-2.

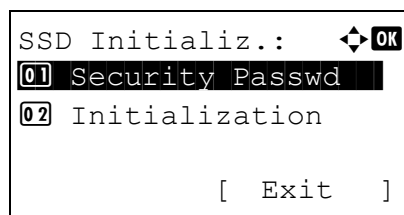

- 4 Press [OK]. If the Security Password entered is correct, the SSD Initializ. menu screen appears. If the Security Password entered was not correct, Incorrect password is displayed and the SecurityPassword screen reappears. Enter the correct Security Password.

SecurityPassword (Change the Security Password)

Change the Security Password.

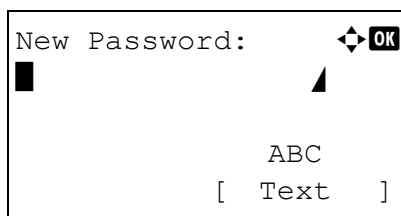

- 1 In the `SSD Initializ.` menu, press Δ or ∇ to select `Security Passwd.`
- 2 Press **[OK]**. The `New Password` entry screen appears.

- 3 Enter the new Security Password using the numeric keys.



Note The Security Password must be between 6 and 16 characters. For details on entering characters, refer to *Character Entry Method* on page A-2.

- 4 Press **[OK]**. The `Confirm Password` entry screen appears.

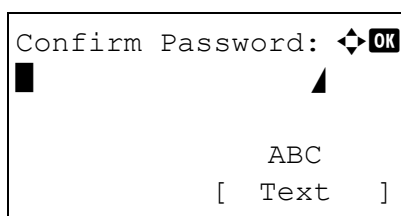

- 5 To confirm, re-enter the security password to be registered. Enter the new Security Password using the numeric keys.
- 6 Press **[OK]**. If the Security Password entered matches then the password is changed to the new password and the `SSD Initializ.` menu reappears.

If the password does not match, `Incorrect password` is displayed and the `New Password` entry screen reappears. Enter again from the new Security Password.

Initialization (Initialize on optional SSD)

Overwrite all the data stored in the optional SSD (HD-6) when disposing of the printer.

IMPORTANT If you accidentally turn the power switch off during initialization, the HD-6 might possibly crash or initialization might fail.

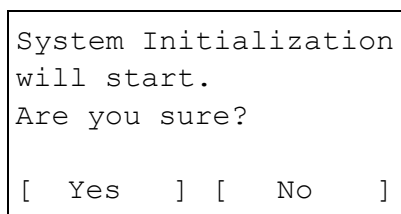

- 1 In the `SSD Initializ.` menu, press Δ or ∇ to select `Initialization.`
- 2 Press **[OK]**. A confirmation message is displayed.
- 3 Press **[Yes] ([Left Select])**. The printer automatically restarts and then initialization starts.
If you do not wish to initialize, press **[No] ([Right Select])**. The `SSD Initializ.` menu reappears.

```
Task is completed.
Turn the main power
switch off and on.
```

- 4 When the initialization is finished `Task is completed.` is displayed. Turn the power switch off and then on.

DataSanitization (Sanitizing the stored data)

This is to completely delete the address information registered on the machine and the stored image data.

IMPORTANT To complete this process requires about 30 minutes when an optional SSD (HD-6) is installed and a few minutes when an SSD (HD-6) is not installed.

You can only performing this operation by logging in with machine administrator privileges.

It is not possible to cancel the process once it has started.

Remove the USB cable and network cable, etc., before performing this operation.

Do not turn off the power supply whilst the deletion is ongoing. If the power switch off during the deletion then the deletion will automatically be performed when the power is switched back on, but a complete operation cannot be guaranteed.

The data deleted is as listed below.

- Job settings
- Machine settings (Network settings)
- Certificates
- User settings (user list, document boxes)
- Machine administration (job logs, job accounting)

 **Note** It is possible to check the status of data sanitization implementation on the Status page. For details, refer to *Status Page (Printing a printer's status page)* on page 4-12.

```
Sanitize the data.
Are you sure?
* This process will
take a while.
[ Yes ] [ No ]
```

- 1 In the `Data Security` menu, press Δ or ∇ to select `DataSanitization`.
- 2 Press **[OK]**. A confirmation message is displayed.
- 3 Press **[Yes] ([Left Select])**. The message `Sanitizing the data.` appears and the data sanitization begins.

 **Note** When an optional SSD (HD-6) is installed, the printer automatically restarts before data sanitization.

Pressing **[No] ([Right Select])** returns to the `Data Security` menu without sanitizing the data.

```
Sanitizing the data.
Main Memory :Complet
SSD          :Complet

[ OK ]
```

- 4 When the data sanitization is finished `Complet` is displayed. Press **[OK] ([Right Select])** and turn the power switch off.

 **Note** It is possible to check the result of data sanitization on the Status page. For details, refer to *Status Page (Printing a printer's status page)* on page 4-12.

User/Job Account (User Login Setting/Job Account setting)

It is possible to set User Login Administration and Job Accounting on this machine.

User/ Job Account has the following items.

- User Login Set. (User login setting)...4-109
- Job Account.Set. (Job Account setting)...4-120

User Login Set. (User login setting)

User Login Administration is a function which makes it possible to specify the users who can use the machine and to manage the users. If the login user name and password entered match those already registered then the user is authenticated and can log in to the machine.

Users are classified into "User", "Administrator" or "DeviceAdmin", depending on their authority. The setting of security levels can only be done by DeviceAdmin.

The authentication for this machine uses a network authentication server. The registration of users is done on the server.

In the local user list for the machine, 1 user with administrator authority and 1 user with device administrator authority are registered. To change the administrator information, refer to *Administrator on page 4-116*.

When the optional Card Authentication Kit is activated, it is possible to log in using an ID card.

First User Login Administration

Follow these steps for the first user login administration.

Enable user login administration. (*page 4-111*)



Add a user on the network server.



Log out. (*page 4-114*)



The registered user logs in for operations. (*page 4-114*)

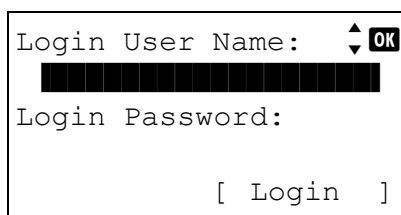

Login User Name: ▲ OK

Login Password:

[Login]

- 1 Press **[Menu]**.
- 2 Press Δ or ∇ to select *User/Job Account*.
- 3 Press **[OK]**. The Login screen appears.



Note When user login administration is set:

- When logged in as an administrator, the log in screen is not displayed and the *User/Job Account* menu screen is displayed.
- The setting is not possible when logged in as anyone other than an administrator. Log in again as an administrator.

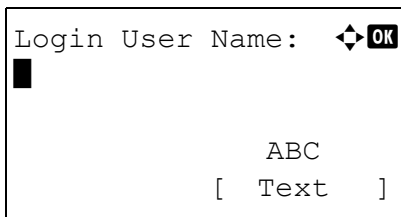

4 With the Login User Name entry field selected, press **[OK]**. The Login User Name entry screen is displayed.

5 Enter the Login User Name using the numeric keys then press **[OK]**. The log in screen reappears.



Note The initial setting for the administrator's Login User Name is "Admin".

For details on entering characters, refer to *Character Entry Method* on page A-2.

6 Press Δ or ∇ to select the Login Password entry field.

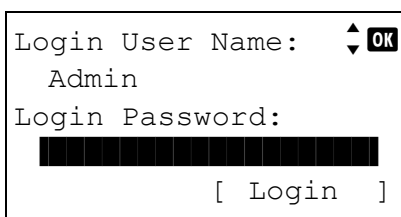

7 Press **[OK]**. The Login Password entry screen is displayed.

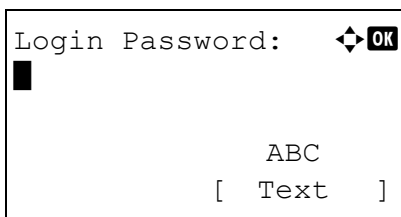

8 Enter the Login Password using the numeric keys then press **[OK]**. The login screen reappears.



Note The initial setting for the administrator's Login Password is "Admin".

For details on entering characters, refer to *Character Entry Method* on page A-2.

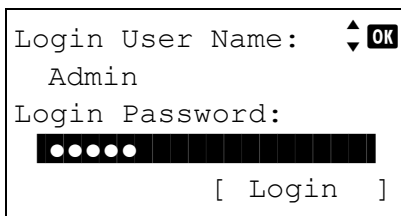

9 Pressing **[Login]** (**[Right Select]**). If the entered Login User Name and Login Password are correct, the User/Job Account menu screen appears.

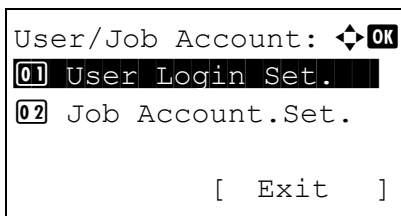

10 Press Δ or ∇ to select User Login Set..

11 Press **[OK]**. The User Login Set. menu appears.

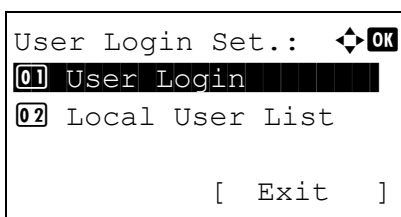

User Login

This enables user login administration. This switches the User Login Administration On/Off and sets the authentication network server.

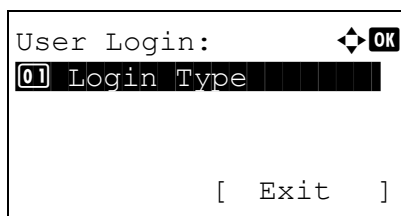

- 1 In the User Login Set. menu, press Δ or ∇ to select User Login.
- 2 Press [OK]. The User Login menu screen appears.

Login Type (Enabling of User Login Administration)

Select Netwk Authentic. to enable User Login Administration.

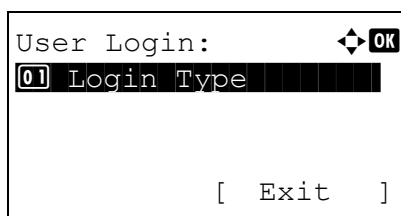

- 1 In the User Login menu, press Δ or ∇ to select Login Type.
- 2 Press [OK]. The Login Type screen appears.

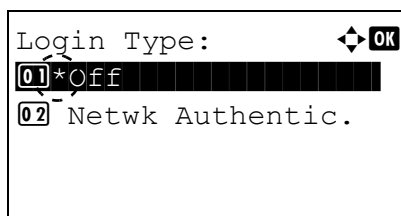

- 3 Press Δ or ∇ to select Netwk Authentic. or Off.

- 4 Press [OK]. The User Login menu reappears.



Note When Netwk Authentic. is selected, set the network authentication server.

Netwk Auth. Set (Netwk authentication setting)

Set the network authentication server.



Note These settings are only displayed when Netwk Authentic. has been set as the Login Type (Enabling of User Login Administration) on page 4-111.

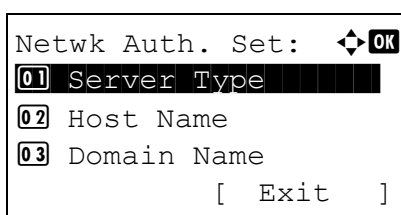

- 1 In the User Login menu, press Δ or ∇ to select Netwk Auth. Set.
- 2 Press [OK]. The Netwk Auth. Set menu screen appears.

The options available in Netwk Auth. Set are as follows:

- Server Type (Server type selection)...4-112
- Host Name (Entering of Host Name)...4-112
- Port (Port number setting)...4-112
- Domain Name (Entering of Domain Name)...4-113

Server Type (Server type selection)

Select the type of server for the authentication server.

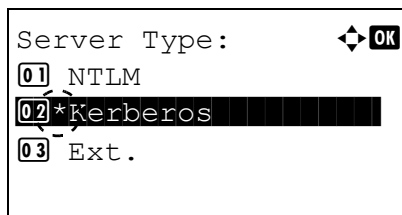

1 In the *Netwk Auth. Set* menu, press Δ or ∇ to select *Server Type*.

2 Press **[OK]**. The *Server Type* screen appears.

The available server types are as follows:

NTLM
Kerberos
Ext.



Note Select *Ext.* to perform ID Card Authentication.

3 Press Δ or ∇ to select the desired server type.

4 Press **[OK]**. The server type is set and the *Netwk Auth. Set* menu reappears.

Host Name (Entering of Host Name)

Enter the host name for the authentication server.

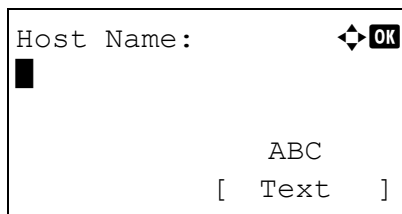

1 In the *Netwk Auth. Set* menu, press Δ or ∇ to select *Host Name*.

2 Press **[OK]**. The *Host Name* screen appears.

3 Enter the host name using the numeric keys.



Note Up to 64 characters can be entered. For details on entering characters, refer to *Character Entry Method on page A-2*.

To enter the IPv6 address, enclose the address in brackets []. (e.g., [3ae3:9a0:cd05:b1d2:28a:1fc0:a1:10ae]:140)

4 Press **[OK]**. The host name is registered and the *Netwk Auth. Set* menu reappears.

Port (Port number setting)

Set the Port number for the authentication server.

 **Note** This setting is only displayed when *Ext.* has been set as the *Server Type (Server type selection)* on page 4-112.

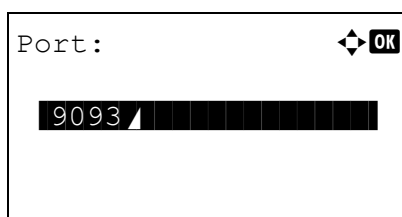

1 In the *Netwk Auth. Set* menu, press Δ or ∇ to select *Port*.

2 Press **[OK]**. The *Port* screen appears.

- 3 Enter the port number using the numeric keys.



Note If the port number is registered as a blank field, the default port number will be enabled.

- 4 Press **[OK]**. The port number is registered and the `Netwk Auth. Set` menu reappears.

Domain Name (Entering of Domain Name)

Enter the domain name for the authentication server.



Note This setting is only displayed when `NTLM` or `Kerberos` has been set as the *Server Type (Server type selection)* on page 4-112.

- 1 In the `Netwk Auth. Set` menu, press Δ or ∇ to select `Domain Name`.
- 2 Press **[OK]**. The `Domain Name` screen appears.

- 3 Enter the domain name using the numeric keys.



Note Up to 256 characters can be entered. For details on entering characters, refer to *Character Entry Method* on page A-2.

- 4 Press **[OK]**. The domain name is registered and the `Netwk Auth. Set` menu reappears.

NW User Property (Obtain the network user property)

This setting is to acquire user information from the LDAP server.



Note This setting is only displayed when `Netwk Authentic.` has been set as the *Login Type (Enabling of User Login Administration)* on page 4-111 and `NTLM` or `Kerberos` has been set as the *Server Type (Server type selection)* on page 4-112.

- 1 In the `User Login Set.` menu, press Δ or ∇ to select `NW User Property`.
- 2 Press **[OK]**. The `NW User Property` menu screen appears.

The options available in `NW User Property` are as follows:

- `Off/On` (Switching network user property acquisition On/Off)...4-113
- `Authenticat Type` (Authenticat type setting)...4-114



Note `Authenticat Type` is only displayed when `Kerberos` has been set as the *Server Type (Server type selection)* on page 4-112.

Off/On (Switching network user property acquisition On/Off)

Set the `NW User Property` to On/Off.

- 1 In the `NW User Property` menu, press Δ or ∇ to select `Off/On`.

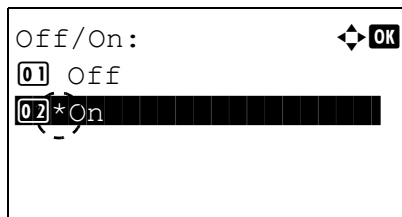

2 Press **[OK]**. The Off/On screen appears.

3 Press Δ or ∇ to select On or Off.

4 Press **[OK]**. The NW User Property menu reappears.

Authenticat Type (Authenticat type setting)

Set the authentication method.

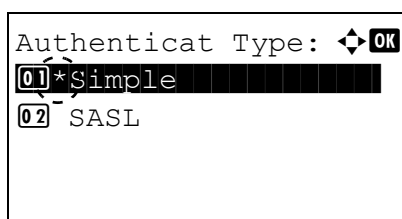

1 In the NW User Property menu, press Δ or ∇ to select Authenticat Type.

2 Press **[OK]**. The Authenticat Type screen appears.

3 Press Δ or ∇ to select Simple or SASL.

4 Press **[OK]**. The NW User Property menu reappears.

Login/Logout

Once you enable user login administration, a login user name and password entry screen appears each time you use this machine. Enter the user information registered on the network authentication server as the login user name and password.

Register new users from the KYOCERA Net Policy Manager. For details, refer to the *KYOCERA Net Policy Manager User Guide*.

 **Note** To carry out operations restricted in the mode selection menu operation and Lock Operation Panel settings, it is necessary to log in as a user with administrator authority.

For the administrator settings, refer to *Administrator on page 4-116*.

For Lock Operation Panel, refer to *Lock Operation Panel on page 2-19*.

Login

Use the procedure below to login.

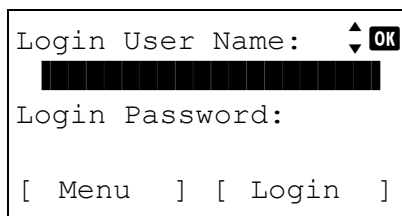

1 With the Login User Name entry field selected, press **[OK]**. The Login User Name entry screen is displayed.

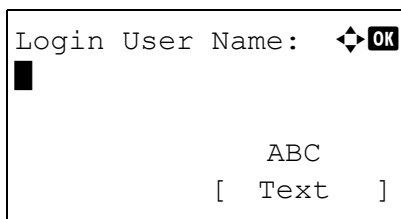

- 2 Enter the Login User Name using the numeric keys then press **[OK]**. The login screen reappears.

 **Note** For details on entering characters, refer to *Character Entry Method* on page A-2.

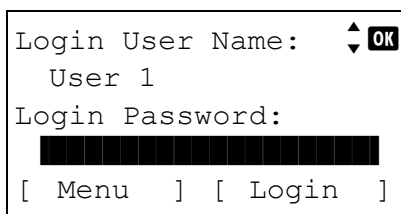

- 3 Press Δ or ∇ to select the Login Password entry field.

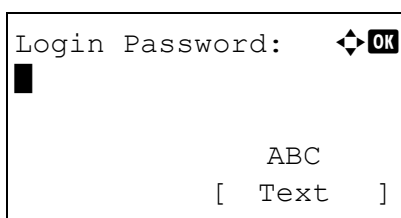

- 4 Press **[OK]**. The Login Password entry screen is displayed.

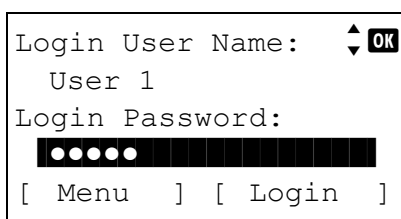

- 5 Enter the Login Password using the numeric keys then press **[OK]**. The login screen reappears.

 **Note** For details on entering characters, refer to *Character Entry Method* on page A-2.

- 6 Check that the correct login user name and password have been entered then press **[Login]** (**[Right Select]**).

 **Note** When Job Accounting is set, it is possible to press **[Menu]** (**[Left Select]**) then select Counter on the menu displayed and press **[OK]** to see the number of pages printed.

Logout

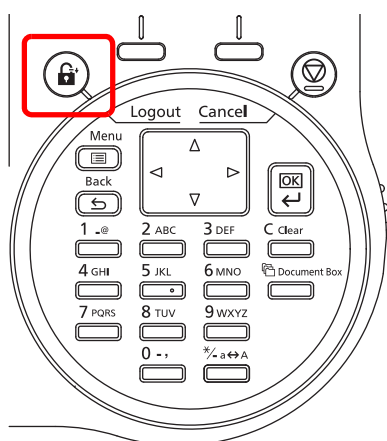

When the operations are finished, press **[Logout]**. The login screen reappears.

Auto Logout

Logout is automatically executed in the following cases:

- When the power supply is off
- When the machine enters the sleep mode after the setting time of Auto Sleep has passed
- When the power of the machine turns off after the setting time of auto power off has passed
- When the settings are restored to the default after the setting time of Auto Panel Reset has passed

Administrator

In the local user list for the machine, 1 user with administrator authority and 1 user with device administrator authority are registered.

Each user's properties are:

Machine Administrator		Administrator	
User Name:	DeviceAdmin	User Name:	Admin
Login User Name:	FS-2100D: 4000 FS-2100DN: 4000 FS-4100DN: 4500 FS-4200DN: 5000 FS-4300DN: 6000	Login User Name:	Admin
Login Password:	FS-2100D: 4000 FS-2100DN: 4000 FS-4100DN: 4500 FS-4200DN: 5000 FS-4300DN: 6000	Login Password:	Admin
Access Level:	Machine Administrator	Access Level:	Administrator

Changing the administrator information

It is possible to change the administrator information. Use the procedure below to change the details registered.

 **Note** Log in as DeviceAdmin to change the administrator information. When logged in as Admin., it is only possible to check the administrator information.

1 In the User Login Set. menu, press Δ or ∇ to select Local User List.

2 Press [OK]. The Local User List screen appears.

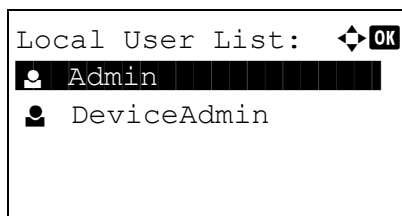

3 Press Δ or ∇ to select the administrator to change.

4 Press [OK]. The detailed information for the user is displayed.

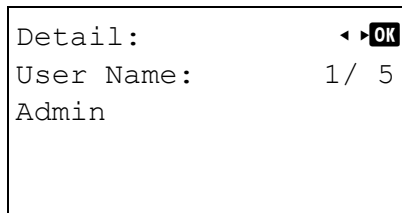

To change the Login User Name

```

Detail:                ◀ ▶ OK
Login User Name: 2/ 5
Admin
                        [ Edit ]
    
```

```

Login User Name:  ◀ ▶ OK
Admin█
                        ABC
                        [ Text ]
    
```

5 Press ◀ or ▶ to select Login User Name.

6 Pressing [Edit] (**[Right Select]**). The screen for editing the Login User Name appears.

7 Change the Login User Name using the numeric keys and press [OK]. The Login User Name screen reappears.



Note Up to 32 characters can be entered. For details on entering characters, refer to *Character Entry Method* on page A-2.

To change the Login Password

```

Detail:                ◀ ▶ OK
Login Password: 3/ 5
●●●●●●●●●●
                        [ Edit ]
    
```

```

New Password:        ◀ ▶ OK
█
                        ABC
                        [ Text ]
    
```

```

Confirm Password:  ◀ ▶ OK
█
                        ABC
                        [ Text ]
    
```

8 Press ◀ or ▶ to select Login Password.

9 Pressing [Edit] (**[Right Select]**). The New Password screen appears.

10 Enter the new password using the numeric keys and press [OK]. The Confirm Password screen reappears.



Note Up to 64 characters can be entered. For details on entering characters, refer to *Character Entry Method* on page A-2.

11 To confirm, re-enter the password to be registered. Enter the Password using the numeric keys.

12 Press [OK]. If the Password matches then the password is changed to the new one and the Login Password screen reappears.

If the password does not match, *Incorrect password* is displayed and the *New Password* screen reappears. Enter again from the new Password.

To change the E-mail Address

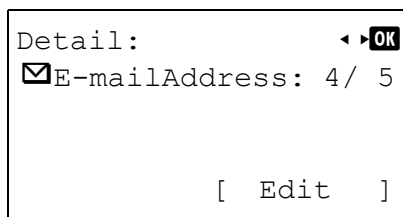

13 Press ◀ or ▶ to select E-mailAddress.

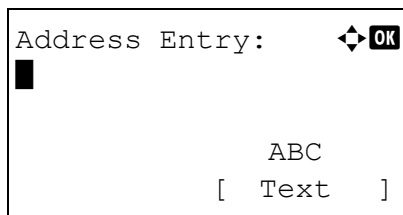

14 Pressing [Edit] (**[Right Select]**). The Address Entry screen appears.

15 Change the address using the numeric keys and press **[OK]**. The E-mailAddress screen reappears.



Note Up to 128 characters can be entered. For details on entering characters, refer to *Character Entry Method* on page A-2.

To change the Account ID



Note This item is only displayed when Job Account is set.

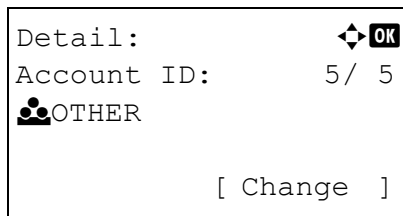

16 Press ◀ or ▶ to select Account ID.

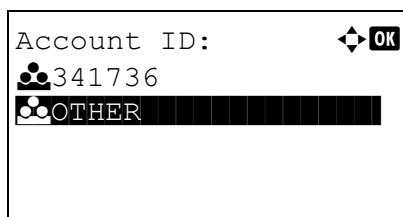

17 Pressing [Change] (**[Right Select]**). The Account ID screen appears.

18 Press ▲ or ▼ to select the Account ID and press **[OK]**. The Account ID screen reappears.



Note For other accounts, select OTHER.

ID Card Settings

This sets the login method when the optional Card Authentication Kit is used and users are managed using ID cards.



Note This item is only displayed when the optional Card Authentication Kit is activated. For details of the Card Authentication Kit, refer to *Card Authentication Kit (B) Operation Guide for Printer*.

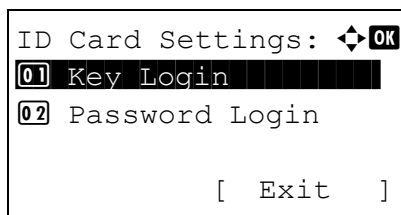

1 In the User Login Set. menu, press Δ or ∇ to select ID Card Settings.

2 Press [OK]. The ID Card Settings menu screen appears.

The options available in ID Card Settings are as follows:

- Key Login (Setting for key login permission)...4-119
- Password Login (Password Login setting)...4-119

Key Login (Setting for key login permission)

This setting also permits logging in using the numeric keys on the ID card login screen. When `Permit` is set, `KeyLogin` is displayed on the login screen and it is possible to log in by entering the Login User Name and Login Password using the numeric keys. When `Prohibit` is set, it is not possible to log in using the numeric keys.

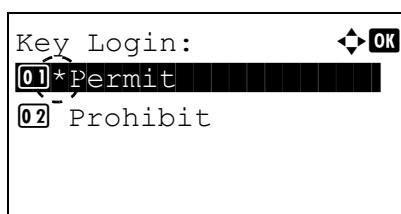

1 In the ID Card Settings menu, press Δ or ∇ to select Key Login.

2 Press [OK]. The Key Login screen appears.

3 Press Δ or ∇ to select `Permit` or `Prohibit`.

4 Press [OK]. The ID Card Settings menu reappears.

Password Login (Password Login setting)

This sets whether or not to require the entry of a Login Password after authentication using an ID card. When set to `On`, the Login Password entry screen is displayed after the ID card is authenticated.

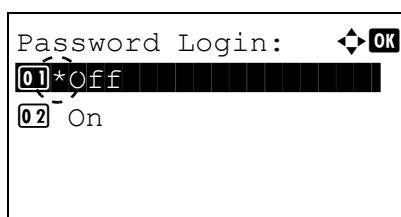

1 In the ID Card Settings menu, press Δ or ∇ to select Password Login.

2 Press [OK]. The Password Login screen appears.

3 Press Δ or ∇ to select `Off` or `On`.

4 Press [OK]. The ID Card Settings menu reappears.

Job Account.Set. (Job Account setting)

Job Accounting is a function that allows the number of pages used by each department to be managed through the use of entered account IDs. To specify the Job Accounting settings, it is necessary to log in with an administrator's Login User Name and Login Password. For details of User Login Administration, refer to *User Login Set. (User login setting)* on page 4-109.

Job accounting on this machine offers the following features:

- Support for up to 100 departments
- Account IDs up to 8 digits long from 1 to 99999999
- Collective print management for the same account ID
- Totaling of the number of pages used for each department
- Specifiable limits (1 to 9,999,999) on the number of pages used

The options available in the Job Account.Set menu are as follows:

- Job Accounting (Job Accounting settings)...4-121
- Account. Report (Account report printing)...4-122
- Each Job Account (Totals display by account)...4-122
- Account. List (Account List operation)...4-123
- Apply Limit (Operation settings when limits are exceeded)...4-126
- Unknown ID Job (Operation settings for unknown account IDs)...4-127

- 1 Press **[Menu]**.
- 2 Press Δ or ∇ to select **User/Job Account**.
- 3 Press **[OK]**. The Login screen appears.



Note When user login administration is set:

- When logged in as an administrator, the log in screen is not displayed and the **User/Job Account** menu screen is displayed.
- The setting is not possible when logged in as anyone other than an administrator. Log in again as an administrator.

- 4 With the **Login User Name** entry field selected, press **[OK]**. The **Login User Name** entry screen is displayed.

- 5 Enter the Login User Name using the numeric keys then press **[OK]**. The log in screen reappears.



Note The initial setting for the administrator's Login User Name is "Admin".

For details on entering characters, refer to *Character Entry Method* on page A-2.

- 6 Press Δ or ∇ to select the **Login Password** entry field.

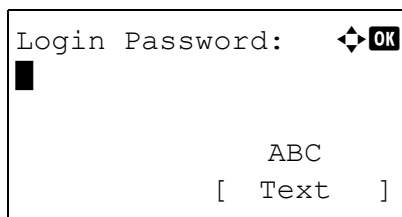

7 Press **[OK]**. The Login Password entry screen is displayed.

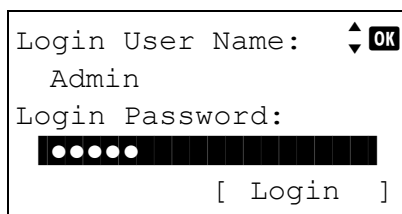

8 Enter the Login Password using the numeric keys then press **[OK]**. The login screen reappears.



Note The initial setting for the administrator's Login Password is "Admin".

For details on entering characters, refer to *Character Entry Method* on page A-2.

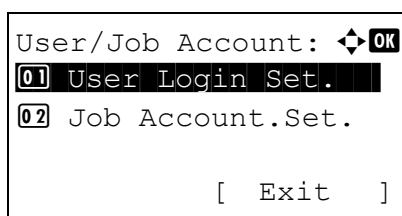

9 Pressing **[Login] ([Right Select])**. If the entered Login User Name and Login Password are correct, the User/Job Account menu screen appears.

10 Press Δ or ∇ to select Job Account.Set..

11 Press **[OK]**. The Job Account.Set. menu appears.

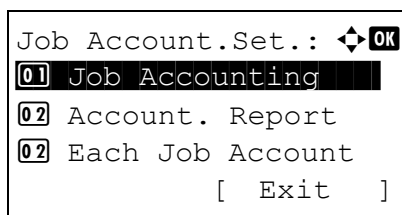

Job Accounting (Job Accounting settings)

This allows you to turn the Job Accounting function On and Off.

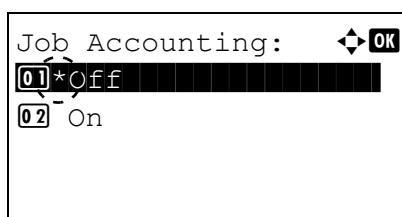

1 In the Job Account.Set. menu, press Δ or ∇ to select Job Accounting.

2 Press **[OK]**. The Job Accounting screen appears.

3 Press Δ or ∇ to select On or Off and then press **[OK]**. The Job Account.Set. menu reappears.

Account. Report (Account report printing)

This enables you to print the total number of pages for all accounts as a Job Accounting list.

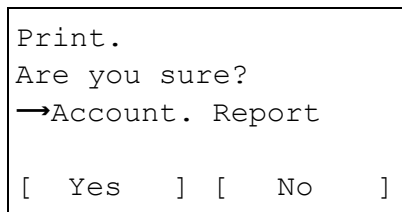

- 1 In the `Job Account. Set.` menu, press Δ or ∇ to select `Account. Report`.
- 2 Press **[OK]**. A confirmation screen appears. Press **[Yes]** (**[Left Select]**). `Accepted.` appears and the printer prints the job accounting list. Pressing **[No]** (**[Right Select]**) returns to the `Job Account. Set.` menu without printing the job accounting list.

Each Job Account (Totals display by account)

Displays the number of pages printed for each of the currently selected accounts.

This enables you to check the following numbers for printed pages:

- Total
- Combine (None)
- Combine (2in1)
- Combine (4in1)
- Duplex (1side)
- Duplex (2side)

 **Note** Before carrying out this operation, register the Account in the *Account. List (Account List operation)* on page 4-123.

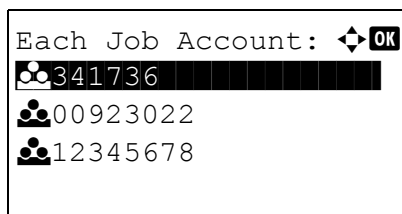

- 1 In the `Job Account. Set.` menu, press Δ or ∇ to select `Each Job Account`.
- 2 Press **[OK]**. The `Each Job Account` menu appears with the accounts with the highest numbers listed first.

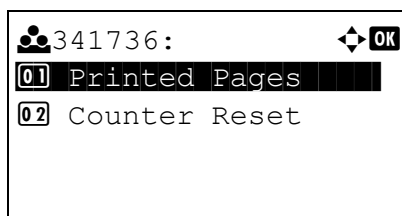

- 3 Press Δ or ∇ to select an account and then press **[OK]**. The `Printed Pages/Counter Reset` menu screen appears.

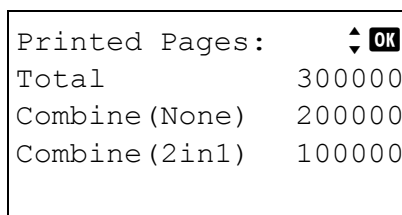

- 4 Press Δ or ∇ to select `Printed Pages`.
- 5 Press **[OK]**. The `Printed Pages` menu list screen appears.

- 6 Press Δ or ∇ to check the required counter display.
- 7 Press [OK]. The Printed Pages/Counter Reset menu screen reappears.

Each Job Account Counter Reset (Totals reset by account)

Resets the number of pages printed for each of the accounts currently set.



Note Before carrying out this operation, register the Account in the *Account. List (Account List operation)* on page 4-123.

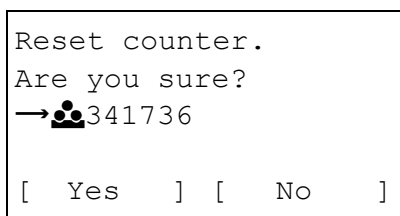
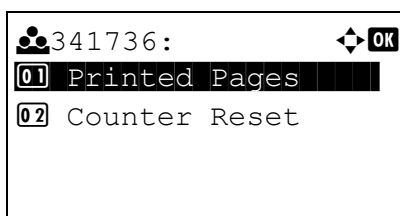
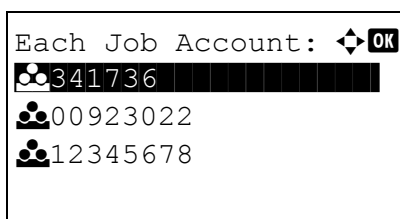

- 1 In the Job Account.Set. menu, press Δ or ∇ to select Each Job Account.
- 2 Press [OK]. The Each Job Account menu appears with the accounts with the highest numbers listed first.
- 3 Press Δ or ∇ to select an account and then press [OK]. The Printed Pages/Counter Reset menu screen appears.
- 4 Press Δ or ∇ to select Counter Reset.
- 5 Press [OK]. The reset confirmation menu screen appears. To proceed with resetting the counter, press [Yes] ([Left Select]). Completed. appears, the counter is reset and the Printed Pages/Counter Reset menu reappears. Pressing [No] ([Right Select]) returns to the Printed Pages/Counter Reset menu screen without resetting the counter.

Account. List (Account List operation)

This specifies the setting for the department to be used for setting Job Accounting.

Add (Account registration)

Use this procedure to add a new account.



Note Because account IDs are managed as numeric strings, "1" and "001" are handled as different accounts. Also, once Job Accounting is enabled, no jobs are printed unless information is attached showing the accounts from which the jobs are being printed.

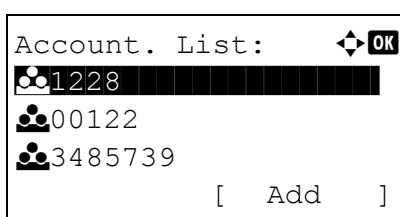

- 1 In the Job Account.Set. menu, press Δ or ∇ to select Account. List.
- 2 Press [OK]. The Account. List menu appears showing a list of the registered accounts in ascending order.

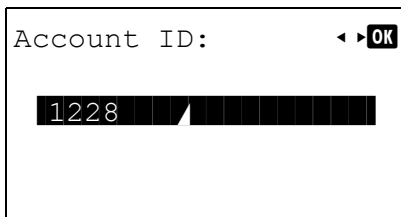

3 Press [Add] ([Right Select]). The Account ID menu screen appears.

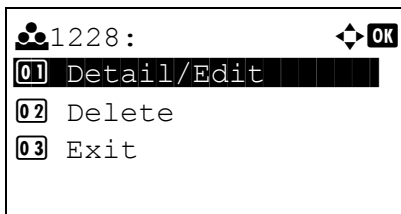

4 Use the numeric keys to enter the account ID to be added.

5 Press [OK]. Once the account has been added, a list of selection options appears.

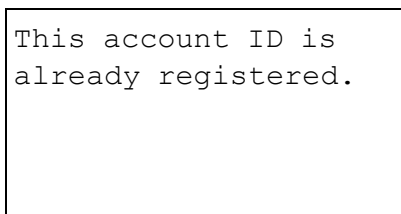

This message appears if the account ID has already been registered.

Detail/Edit (Checking/editing registered account ID settings)

This procedure allows you to check or edit registered accounts.

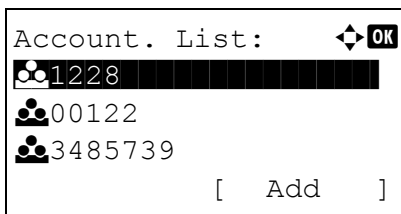

1 In the Job Account.Set. menu, press Δ or ∇ to select Account List.

2 Press [OK]. The Account List menu appears showing a list of the registered accounts in ascending order.

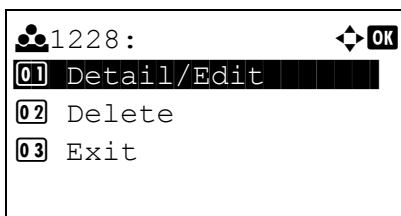

3 Press Δ or ∇ to select an account to check or edit and then press [OK]. A list of selection options appears.

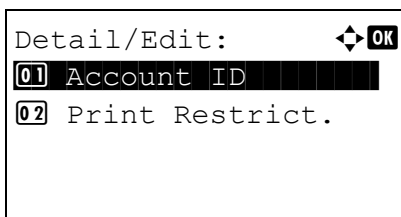

4 Press Δ or ∇ to select Detail/Edit and then press [OK]. The Detail/Edit menu screen appears.

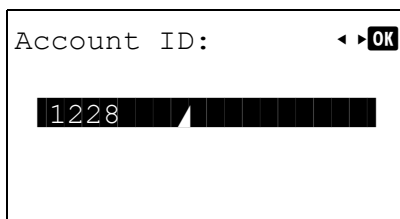

5 To edit an account ID, press Δ or ∇ to select `Account ID` and then press **[OK]**. The `Account ID` menu screen appears.

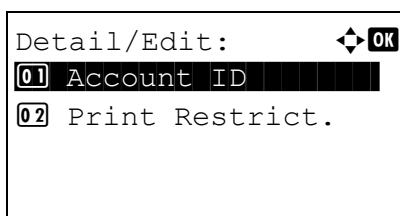

6 Use the numeric keys to enter the new account ID.

7 Press **[OK]**. When account ID editing has been completed, the `Detail/Edit` menu screen appears.

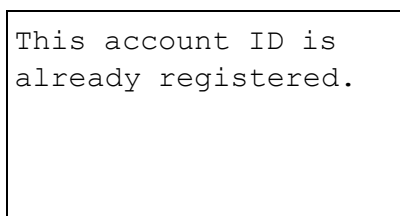

This message appears if the account ID has already been registered.

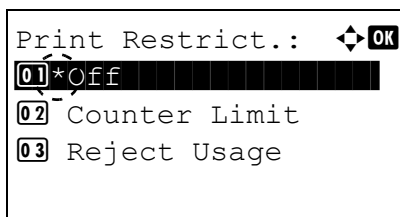

8 To place printing restrictions on this account, press Δ or ∇ to select `Print Restrict.` and then press **[OK]**. The `Print Restrict.` screen appears.

- Off
- Counter Limit
- Reject Usage

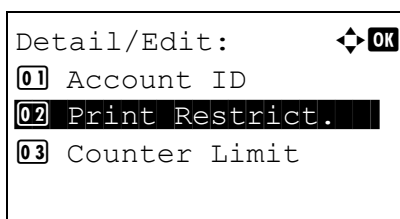

9 Press Δ or ∇ to select a setting and then press **[OK]**. When the setting has been completed, the `Detail/Edit` menu screen appears.

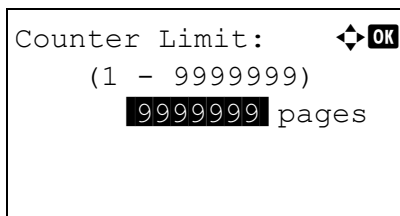

10 When `Counter Limit` is set for `Print Restrict.` in step 9, set the limit on the total number of pages that can be printed using this account. Press Δ or ∇ to select `Counter Limit` and then press **[OK]**. The `Counter Limit` menu screen appears.

IMPORTANT `Counter Limit` is displayed when `Counter Limit` is set for `Print Restrict.`.

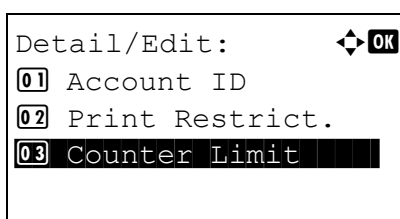

11 Use the numeric keys or Δ or ∇ to enter the limit you want to set for this account. After you have entered the limit on the number of pages, press **[OK]**. The setting is stored and the `Detail/Edit` menu reappears.

Delete (Deleting registered accounts)

You can use this procedure to delete a registered account ID.

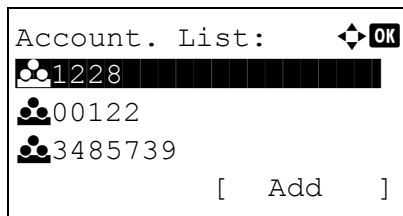

- 1 In the Job Account.Set. menu, press Δ or ∇ to select Account. List.
- 2 Press [OK]. The Account. List menu appears showing a list of the registered accounts in ascending order.

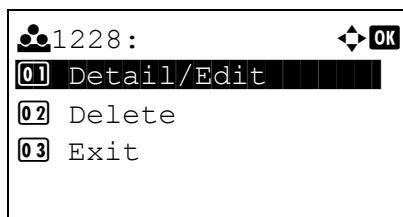

- 3 Press Δ or ∇ to select the ID of the account to be deleted.
- 4 Press [OK]. A list of selection options appears.

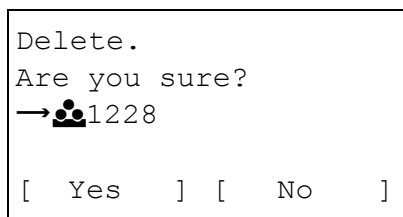

- 5 Press Δ or ∇ to select Delete and then press [OK]. A confirmation screen appears.

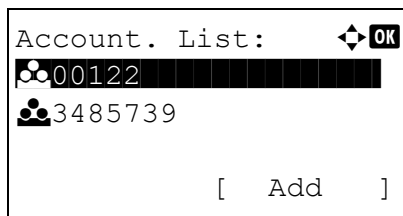

- 6 To proceed with deleting the account, press [Yes] ([Left Select]). Completed. appears and the account is deleted. The once deleting of the account ends, the Account. List screen reappears. Pressing [No] ([Right Select]) returns to the list of selections options without deleting the account.

Apply Limit (Operation settings when limits are exceeded)

Use this to specify the action taken when a department exceeds its printing limits.

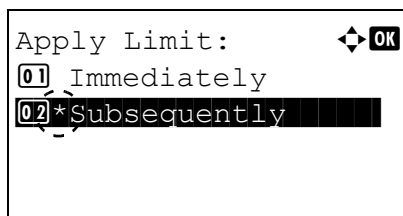

- 1 In the Job Account.Set. menu, press Δ or ∇ to select Apply Limit.
- 2 Press [OK]. The Apply Limit screen appears.
 - Immediately (prohibit printing from this job onwards)
 - Subsequently (prohibit printing from the next job onwards)

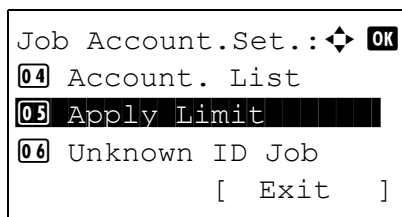

- 3 Press Δ or ∇ to select a setting and then press **[OK]**. The Job Account.Set. menu list reappears.

Unknown ID Job (Operation settings for unknown account IDs)

Use this procedure to specify whether print jobs from departments with unknown account IDs are permitted.

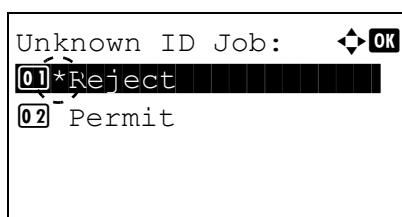

- 1 In the Job Account.Set. menu, press Δ or ∇ to select Unknown ID Job.
- 2 Press **[OK]**. The Unknown ID Job screen appears.
 - Reject (Not printed)
 - Permit (Printed)

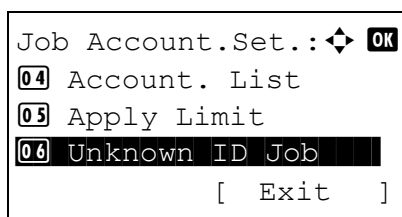

- 3 Press Δ or ∇ to select a setting and then press **[OK]**. The Job Account.Set. menu list reappears.

Adjust/Maint. (Adjust/Maintenance selection/setting)

Adjust/Maintenance is used to adjust the print quality and to carry out printer maintenance.

The options available in Adjust/Maintenance are as follows:

- Restart (Restart Printer)...4-128
- Service Setting (for Maintenance)...4-128

IMPORTANT *Service Setting* is primarily a menu used by service personnel for maintenance work. There is no need for customers to use this menu.

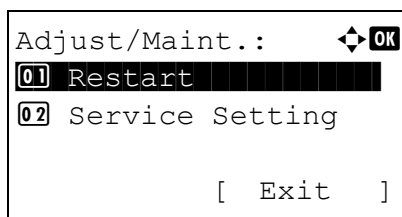

- 1 Press **[Menu]**.
- 2 Press Δ or ∇ to select *Adjust/Maint.*.
- 3 Press **[OK]**. The *Adjust/Maint.* menu appears showing a list of available options.

Restart (Restart Printer)

The procedure described below resets the printer's temporary conditions, such as the current page orientation, font, etc., set by commands to their default values. Downloaded fonts and macros are deleted from the printer's memory.

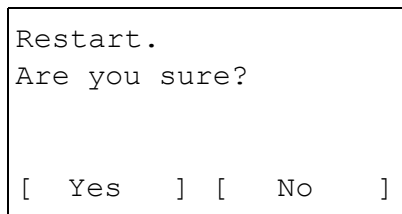

- 1 In the *Adjust/Maint.* menu screen, press Δ or ∇ to select *Restart.*
- 2 Press **[OK]**. A confirmation screen appears.
Press **[Yes]** (**[Left Select]**). The printer is restarted.
Pressing **[No]** (**[Right Select]**) returns to the *Adjust/Maint.* menu screen without restarting the printer.

Service Setting (for Maintenance)

IMPORTANT *Service Setting* is primarily a menu used by service personnel for maintenance work.

Item	Description	Value
Service Status	The service status page contains printer settings information that is more detailed than the standard status page and is therefore mostly for service purposes. However, there is a great deal of information on the service status page that may be useful to you.	Yes, No
Network Status	The network status page contains detailed information on the network settings. This is primarily used for maintenance by service personnel, but it contains information that may also be useful to you. Note The <i>Network Status</i> menu is only displayed on network compatible models.	Yes, No

Item	Description	Value
Op Netwk Status	<p>The option network status page contains detailed information on the network settings. This is primarily used for maintenance by service personnel, but it contains information that may also be useful to you.</p> <p>Note The <code>Op Netwk Status</code> menu is only displayed when the optional network interface kit (IB-50) or wireless network interface kit (IB-51) is installed.</p>	Yes, No
Test Page	<p>The test page is printed to check the effectiveness of printer adjustments. This is primarily used for maintenance by service personnel, but it contains information that may also be useful to you.</p>	Yes, No
Maintenance	<p>This specifies the setting for confirmation of replacement with the new Maintenance Kit (resets the total number of Maintenance Kit print images). This is primarily used for maintenance by service personnel.</p> <p>Note The Maintenance menu is displayed only when <code>Replace MK.</code> appears.</p>	Yes, No
New Developer	<p>This specifies the setting for confirmation of replacement with the new Developer (resets the total number of Developer print images). This is primarily used for maintenance by service personnel.</p>	Yes, No
Auto DrumRefresh	<p>An automatic drum refresh is sometimes carried out when the power supply is switched on or when the machine recovers from sleep mode. In order to maintain the image quality, the automatic drum refresh is implemented automatically after observing the surrounding temperature and humidity. Here, the time for carrying out the automatic drum refresh is set.</p>	Off, Short, Standard, Long
Drum	<p>This sets the refresh mode for the drum. When the printing quality declines, refreshing the drum can restore the printing quality. This is primarily used for maintenance by service personnel.</p>	Yes, No
Write Data	<p>This writes data to USB memory.</p> <p>Note This menu only appears when USB memory is inserted.</p>	Yes, No
Altitude Adj.	<p>This sets the altitude adjustment mode. If you are using the machine at an altitude of 1500 m or higher and print quality has deteriorated, the Altitude Adjustment mode setting can be used to restore print quality.</p>	Normal, High 1, High 2
MC	<p>This sets the output of the main charger. When print quality has deteriorated, the output of the main charger can be changed to restore print quality.</p> <p>Note This menu only appears when <code>Altitude Adj.</code> is set to <code>Normal</code>.</p>	1 - 5

Op Functions (Optional application settings)

You can use the optional applications installed on this machine.

Application

The applications listed below are installed on this machine.

You can use these applications for a limited period on a trial basis.

- DATA SECURITY (Data Security Kit(E))
- ID Card (Card Authentication Kit(B))
- UG-33 (ThinPrint)

 **Note** Restrictions such as the number of times the application can be used during the trial period differ depending on the application.

The options available in Op Functions menu are as follows:

- Starting Application Use...4-130
- Checking Application Details...4-132

Starting Application Use

Use the procedure below to start using an application.

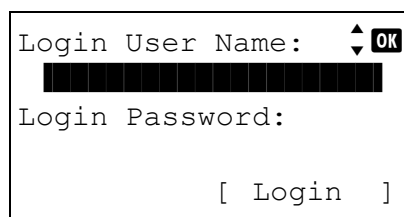
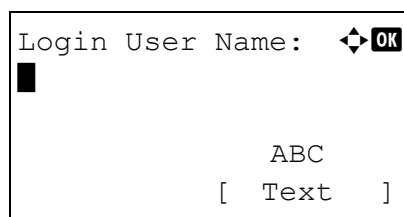
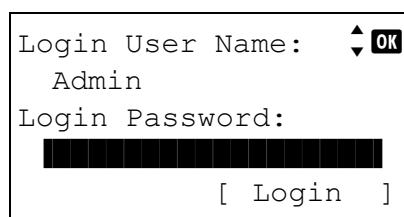
- 1 Press **[Menu]**.
- 2 Press Δ or ∇ to select Op Functions.
- 3 Press **[OK]**. The Login screen appears.



Note When user login administration is set:

- When logged in as an administrator, the log in screen is not displayed and the Op Functions menu screen is displayed.
- The setting is not possible when logged in as anyone other than an administrator. Log in again as an administrator.

- 4 With the Login User Name entry field selected, press **[OK]**. The Login User Name entry screen is displayed.

- 5 Enter the Login User Name using the numeric keys then press **[OK]**. The log in screen reappears.



Note The initial setting for the administrator's Login User Name is "Admin".

For details on entering characters, refer to *Character Entry Method* on page A-2.

- 6 Press Δ or ∇ to select the Login Password entry field.

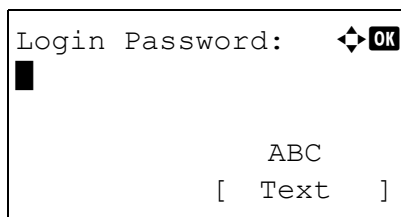

7 Press **[OK]**. The Login Password entry screen is displayed.

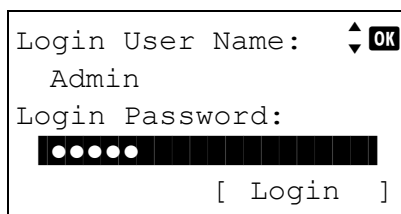

8 Enter the Login Password using the numeric keys then press **[OK]**. The login screen reappears.



Note The initial setting for the administrator's Login Password is "Admin".

For details on entering characters, refer to *Character Entry Method* on page A-2.

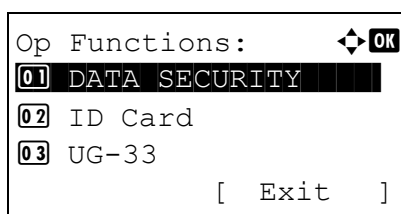

9 Pressing **[Login]** (**[Right Select]**). If the entered Login User Name and Login Password are correct, the Op Functions menu appears.

10 Press Δ or ∇ to select the desired application.

11 Press **[OK]**.

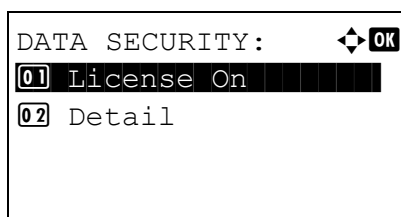

12 Press Δ or ∇ to select License On.



Note You can view detailed information on the selected application by selecting Detail.

13 Press **[OK]**.

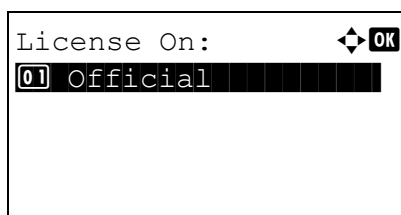

14 Press Δ or ∇ to select Official.



Note To use the application as a trial, select Trial and press **[OK]**. The confirmation screen is displayed so press **[Yes]** (**[Left Select]**).

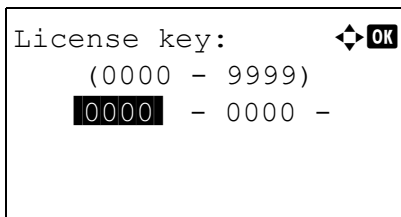

15 Press [OK].

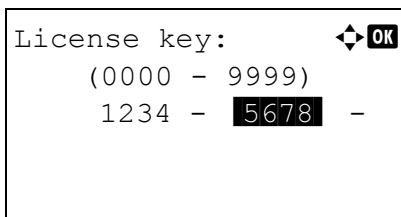

16 Use the numeric keys or press Δ or ∇ to enter the license key.



Note Some applications do not require you to enter a license key.

17 Press [OK].

18 When the confirmation screen appears, press [Yes] ([Left Select]).

IMPORTANT If you change the date/time while using an application, you will no longer be able to use the application.



Note If a message prompting a restart is displayed after changes have been made then obey the message and switch the machine OFF and ON again.

Checking Application Details

Use the procedure below to check the details of an application.

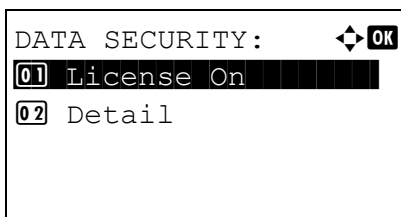

1 In the Op Functions menu, press Δ or ∇ to select the application to check the details of.

2 Press [OK].

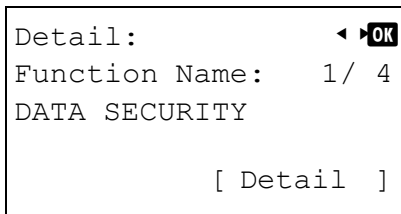

3 Press Δ or ∇ to select Detail.

4 Press [OK]. You can now view detailed information on the selected application.

5 Document Box

This chapter contains explanations on the following topics:

Document Box	5-2
Custom Box	5-4
Job Box	5-24
Computer settings (Printer driver)	5-34

Document Box

The Document Box is a function for saving print data from a computer onto the SSD (optional), SD/SDHC Memory Card (optional) or RAM disk on the machine and then printing it by operating the operation panel.

Press **[Document Box]** to display the Document Box menu.

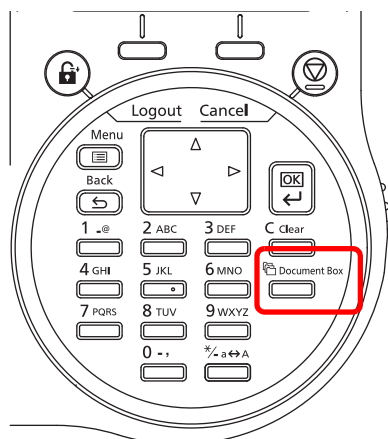

Document Box has the following functions.

- Custom Box...5-4
- Job Box...5-24

 **Note** When an SD/SDHC Memory Card (optional) is installed, it is possible to use Job Box. Using the RAM disk makes it possible to use some of the Job Box functions.

Outline of Custom Box and Job Box

The outline of Custom Box and Job Box and the options required are as follows:

	Custom Box	Job Box
Primary function	This is a general-purpose box. Print data can be stored to the Custom Box and then re-used whenever necessary.	Job Box is a print function that makes the Job Retention function possible. Job Retention has four modes as summarized below. Quick Copy: To later print additional copies Proof-and-Hold: To proof the first copy before printing multiple copies Private Print: To hold the document in printer to prevent unauthorized access Stored Job: To electronically store documents such as fax cover pages
Start storing by	Printer driver	Printer driver
Adding more boxes	Yes (to a maximum of 1,000 boxes)	No
Password setting	Yes	Yes (possible in Private Print and Stored Job)
Data after printing	Stored	Stored except Private Print
Support for User Login Administration	Yes (The users can be set separately for each Box)	No

		Custom Box	Job Box
Installation options	SSD	Available	Available
	SD/SDHC Memory Card	Not available	Available
RAM disk use		Not available	Available (Only Proof-and-Hold and Private Print can be used)



Note For information on the optional SSD and SD/SDHC memory cards, refer to *About the Options* on page A-5.

For information on the RAM disk, refer to *RAM Disk Setting (Using the RAM disk)* on page 4-81.

For the formatting of the SSD, refer to *Format SSD (Formatting the SSD)* on page 4-82.

For the formatting of the SD/SDHC Memory Card, refer to *Format SD Card (Formatting the SD/SDHC memory card)* on page 4-83.

Custom Box

IMPORTANT To use a Custom Box, an optional SSD (HD-6) must be installed in the printer. The HD-6 must be formatted from the printer. For more information, refer to *Format SSD (Formatting the SSD) on page 4-82*.

The Custom Box is a general-purpose box which allows the user to save print data on the printer's SSD and then re-use it whenever necessary.

The transmission of data to save in the box is done with the printer driver. For more information, refer to the *Printer Driver User Guide*.

Use the printer's operation panel to print the print data stored in a Custom Box.

 **Note** On network compatible models, the creation and setting of Custom Boxes is also possible from Command Center RX.

Procedure for printing using Custom Box

Follow the work flow below when using Custom Box.

Registering the Custom Box (*page 5-5*)



Specifying the Custom Box from a computer and sending the print job (*page 5-34*)



Using the operation panel to specify a file within a Box and printing it (*page 5-16*)

Operation panel display

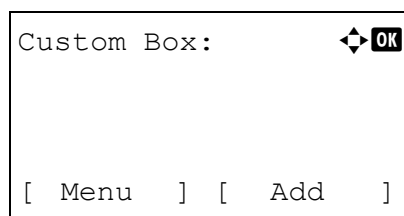

- 1 Press **[Document Box]**. Either the Custom Box list screen or the Job Box menu screen is displayed.

 **Note** After pressing **[Document Box]**, it is possible to display either the Custom Box list screen or the Job Box menu screen or to set them. Refer to *Def. Screen(Box) (Document Box default screen setting) on page 4-75*.

If the Job Box menu screen is displayed, follow the procedure below to display the Custom Box list screen.

- 1 Press **[Back]**.
- 2 Press Δ or ∇ to select Custom Box.
- 3 Press **[OK]**. The Custom Box list screen appears.

The options available in Custom Box are as follows:

- Custom Box operation (Box creation, editing and deletion)...5-5
- File operations (Printing, deleting and moving files)...5-16

Custom Box operation (Box creation, editing and deletion)

It is possible to create Custom Boxes and change Box settings.

The following operations are possible:

- Custom Box creation...5-5
- Editing and Deleting Custom Boxes...5-12
- Sorting the Custom Box list...5-13
- Searching Custom Boxes...5-14
- Setting automatic document deletion for Custom Boxes...5-15

 **Note** The creation and setting of Custom Boxes is also possible from Command Center RX. For more information, refer to the *Command Center RX User Guide*.

Custom Box creation

Create a Custom Box. Enter the Box Name and Box Number then it is possible to continue on and set the details of the Box.

 **Note** When user login administration is enabled, log in as a user with administrator authority.

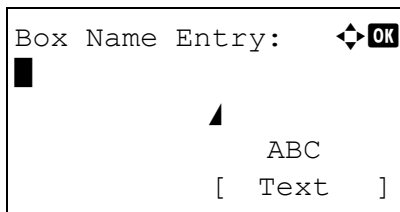

- 1 In the Custom Box list screen, press [Add] (**[Right Select]**). The Box Name Entry screen appears.

- 2 Enter the Box Name using the numeric keys.

 **Note** Up to 32 characters can be entered.
For details on entering characters, refer to *Character Entry Method* on page A-2.

- 3 Press [OK]. The Box Number Entry screen appears.

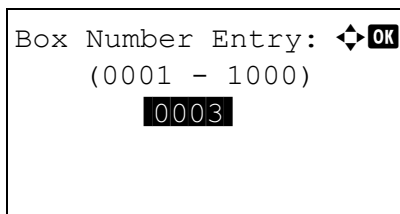

- 4 Use the numeric keys or press Δ or ∇ to enter the Box Number.

 **Note** Enter the Box Number as a four-digit number from 0001 - 1000.

- 5 Press [OK].

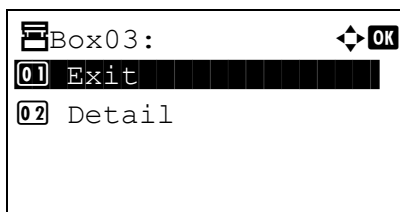

- 6 Press Δ or ∇ to select Detail or Exit then press [OK].

To set the details of the Box, select `Detail` and proceed to *Detailed box settings on page 5-6*.

If the details of the Box will not be set then select `Exit` and finish the operation.

Detailed box settings

Set the details of the Box when necessary. The items to set are different between when user login administration is not enabled, when user login administration is enabled and the user is logged in with administrator authority and when user login administration is enabled and the user is logged in with user authority.

Detail:	◀ ▶ OK
Box Name:	1 / 9
Box03	
[Edit]	

The detailed settings for the Box are as shown below.

Setting	User login Off	User login On		Reference Page
		Administrator	User	
Box Name	Yes	Yes	Yes	Box Name (Change the Box name)...5-7
Owner	–	Yes	No	Owner (Owner settings)...5-7
Permission	–	Yes	Yes	Permission (settings for the sharing of a Box)...5-8
Box Password	Yes	Yes	Yes	Box Password (Box password setting)...5-8
Box Number	Yes	Yes	Yes	Box number (Change of the Box number)...5-9
Usage Restrict.	Yes	Yes	No	Usage Restrict. (Setting for maximum possible capacity usage)...5-9
Auto File Del.	Yes	Yes	Yes	Auto File Del. (Setting for automatic file deletion)...5-10
Overwrite Set.	Yes	Yes	Yes	Overwrite Set. (Setting of overwrite storage)...5-11
Del. afterPrint	Yes	Yes	Yes	Del. afterPrint (Setting for file deletion after printing)...5-11

Yes: The setting can be changed.

No: The setting cannot be changed.

–: No setting

Box Name (Change the Box name)

Change the Box name.

```

Detail:          ◀ ▶ OK
Box Name:       1/9
Box03
                [ Edit ]
  
```

```

Box Name Entry:  ⬆ ⬇ ⬅ ➡ OK
Box03█
                ▲
                ABC
                [ Text ]
  
```

1 In the `Detail` menu screen, press ◀ or ▶ to select `Box Name`.

2 Press `[Edit]` (**[Right Select]**). The `Box Name Entry` screen appears.

3 Enter the Box Name using the numeric keys.



Note Up to 32 characters can be entered.

Refer to *Character Entry Method* on page A-2 for details on entering characters.

4 Press **[OK]**. The `Detail` menu screen reappears.

Owner (Owner settings)

When user login administration is enabled, set the owner of the Box. If the owner is not set then the owner name is displayed as -----.

```

Detail:          ◀ ▶ OK
Owner:          2/9
Smith
                [ Change ]
  
```

```

User setting:    ⬆ ⬇ ⬅ ➡ OK
01 Network User
02 None
  
```

1 In the `Detail` menu screen, press ◀ or ▶ to select `Owner`.

2 Press `[Change]` (**[Right Select]**). The `User setting` screen appears.

3 Press ▲ or ▼ to select `Network User`.



Note If the owner will not be set then select `None` and press **[OK]**.

4 Press **[OK]**. The `Login User Name` screen appears.

```

Login User Name: ⬆ ⬇ ⬅ ➡ OK
█
                ABC
                [ Text ]
  
```

- 5 Enter the Login User Name using the numeric keys.



Note Up to 64 characters can be entered.

Refer to *Character Entry Method* on page A-2 for details on entering characters.

- 6 Press [OK]. The `Detail` menu screen reappears.

Permission (settings for the sharing of a Box)

When user login administration is enabled, this setting determines whether or not a Box will be shared with other users.

Detail: ◀ ▶ [OK]
 Permission: 3/9
 Shared
 [Change]

- 1 In the `Detail` menu screen, press ◀ or ▶ to select `Permission`.

Permission: ⬆ ⬇ ⬅ [OK]
 01 *Shared
 02 Private

- 2 Press [Change] ([Right Select]). The `Permission` screen appears.

- 3 Press △ or ▽ to select `Shared` or `Private`.

- 4 Press [OK]. The `Detail` menu screen reappears.

Box Password (Box password setting)

It is possible to set a password for a box and restrict the users who have access to it. Enter one if necessary.



Note This setting is not displayed when user login administration is enabled and the *Permission (settings for the sharing of a Box)* on page 5-8 has been set to `Private`.

Detail: ◀ ▶ [OK]
 Box Password: 4/9
 ●●●●●●●●
 [Edit]

- 1 In the `Detail` menu screen, press ◀ or ▶ to select `Box Password`.

New Password: ⬆ ⬇ ⬅ [OK]
 █
 ABC
 [Text]

- 2 Press [Edit] ([Right Select]). The `New Password` entry screen appears.

- 3 Enter the new password using the numeric keys.



Note Up to 16 characters can be entered. For details on entering characters, refer to *Character Entry Method* on page A-2.

```

Confirm Password: ◀ ▶ OK
█
                                ▲
                                ABC
                                [ Text ]

```

4 Press **[OK]**. The `Confirm Password` entry screen appears.

5 To confirm, re-enter the password to be registered. Enter the password using the numeric keys.

6 Press **[OK]**. If the password is correct, the setting is changed to the new password and the `Detail` menu screen reappears.

If the password is not correct, the display shows `Incorrect password.` and returns to the `New Password` screen, so enter again from the new password.

Box number (Change of the Box number)

Change the Box number.

```

Detail: ◀ ▶ OK
Box Number: 5/9
0002
                                [ Edit ]

```

1 In the `Detail` menu screen, press ◀ or ▶ to select `Box Number`.

```

Box Number Entry: ◀ ▶ OK
(0001 - 1000)
0002

```

2 Press **[Edit]** (**[Right Select]**). The `Box Name Entry` screen appears.

3 Use the numeric keys or press ▲ or ▼ to enter the Box Number.



Note Enter the Box Number as a four-digit number from 0001 - 1000.

If the display shows `This box number is already registered.`, this Box Number is already in use. Register a different Box Number.

4 Press **[OK]**. The `Detail` menu screen reappears.

Usage Restrict. (Setting for maximum possible capacity usage)

It is possible to restrict the capacity of Boxes in order to preserve the SSD capacity. To limit the usage capacity, enter the maximum value (MB) using the numeric keys. The limit value will vary depending on the number of user Boxes that are created, but it is possible to enter the maximum between 1 and 30,000 (MB).

```

Detail: ◀ ▶ OK
Usage Restrict.: 6/9
200MB
                                [ Change ]

```

1 In the `Detail` menu screen, press ◀ or ▶ to select `Usage Restrict..`

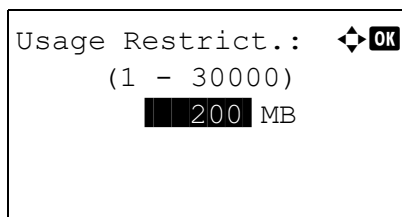

- 2 Press [Change] (**[Right Select]**). The Usage Restrict. screen appears.

- 3 Enter the limit value using the numeric keys, Δ or ∇ .

- 4 Press **[OK]**. The Detail menu screen reappears.

Auto File Del. (Setting for automatic file deletion)

This automatically deletes the documents that have been saved after a fixed period. Set to On for the automatic deletion and then enter the number of days that the documents will be stored. Between 1 and 31 (days) can be entered. Set to Off if automatic deletion will not be used.

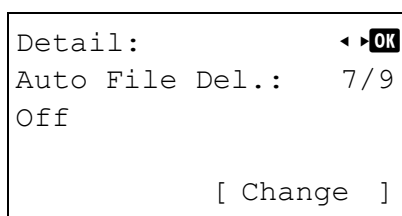

- 1 In the Detail menu screen, press \triangleleft or \triangleright to select Auto File Del..



- 2 Press [Change] (**[Right Select]**). The Auto File Del. menu screen appears.

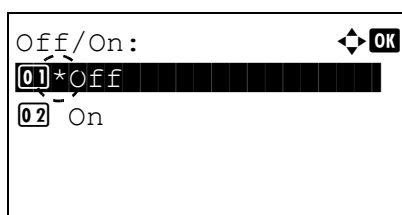

- 3 Press Δ or ∇ to select Off/On.

- 4 Press **[OK]**. The Off/On screen appears.

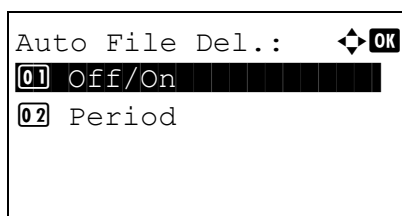

- 5 Press Δ or ∇ to select On or Off.

- 6 Press **[OK]**. The Auto File Del. menu screen reappears.



Note If On has been selected, set the number of days for storage as the Period. Period is only displayed if it has been set to On.

- 7 Press Δ or ∇ to select Period.

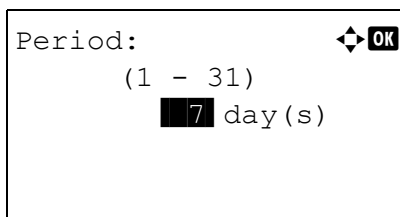

8 Press **[OK]**. The `Period` screen appears.

9 Enter the number of days for storage using the numeric keys, Δ or ∇ .

10 Press **[OK]**. The `Detail` menu screen reappears.

Overwrite Set. (Setting of overwrite storage)

This setting is used to permit or prohibit the overwriting of old documents that have been stored for the storage of new documents.

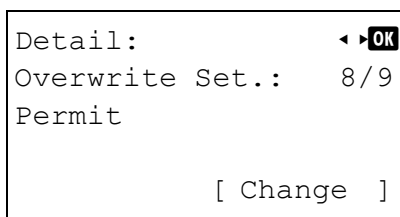

1 In the `Detail` menu screen, press \triangleleft or \triangleright to select `Overwrite Set..`

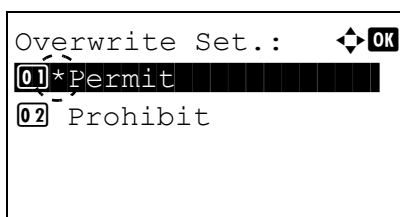

2 Press **[Change]** (**[Right Select]**). The `Overwrite Set.` screen appears.

3 Press Δ or ∇ to select `Permit` or `Prohibit`.

4 Press **[OK]**. The `Detail` menu screen reappears.

Del. afterPrint (Setting for file deletion after printing)

This automatically deletes the documents from the Boxes when the printing is complete.

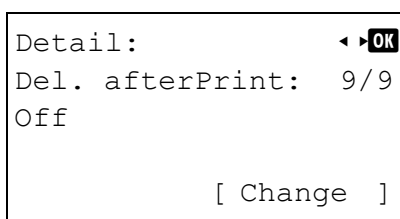

1 In the `Detail` menu screen, press \triangleleft or \triangleright to select `Del. afterPrint.`

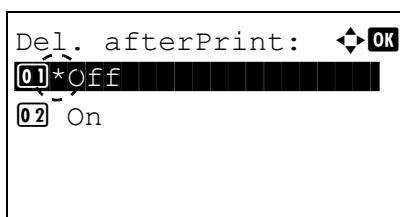

2 Press **[Change]** (**[Right Select]**). The `Del. afterPrint` screen appears.

3 Press Δ or ∇ to select `On` or `Off`.

4 Press **[OK]**. The `Detail` menu screen reappears.

Editing and Deleting Custom Boxes

It is possible to change the detailed settings of the Custom Boxes and to delete Boxes.

```

Custom Box:  [OK]
┌───┴───┐
│ 0001 ABC box │
│ 0002 XYZ box │
│ 0003 Common  │
│ [ Menu ] [ Add ] │
└───┴───┘

```

- 1 In the Custom Box list screen, press Δ or ∇ to select the Box to edit or delete.

```

0001 ABC box:  [OK]
┌───┴───┐
│ All Files │
│ AAAA [x]  │
│ BBBB [ ]  │
│ [ Menu ] [ Select ] │
└───┴───┘

```

- 2 Press [OK]. The file list screen for the Box selected is displayed.

 **Note** If the screen for entering a password is displayed then enter the password using the numeric keys and then press [OK].

Refer to *Character Entry Method* on page A-2 for details on entering characters.

The following operations are possible:

- Editing Custom Boxes...5-12
- Deleting Custom Boxes...5-12

Editing Custom Boxes

```

Menu:  [OK]
┌───┴───┐
│ 01 Search (Name) │
│ 02 Box Detail/Edit │
│ 03 Delete        │
└───┴───┘

```

- 1 In the file list screen, press [Menu] ([Left Select]). The Menu screen appears.

```

Detail:  [OK]
Box Name: 1/9
Box03
[ Edit ]

```

- 2 Press Δ or ∇ to select Box Detail/Edit.

- 3 Press [OK]. The Detail screen appears.

- 4 Press \leftarrow or \rightarrow to check each of the settings and make changes.

 **Note** For the method for making changes, refer to *Detailed box settings* on page 5-6.

- 5 When the editing is completed press [OK]. The file list screen reappears.

Deleting Custom Boxes

```

Menu:  [OK]
┌───┴───┐
│ 01 Search (Name) │
│ 02 Box Detail/Edit │
│ 03 Delete        │
└───┴───┘

```

- 1 In the file list screen, press [Menu] ([Left Select]). The Menu screen appears.

- 2 Press Δ or ∇ to select Delete.

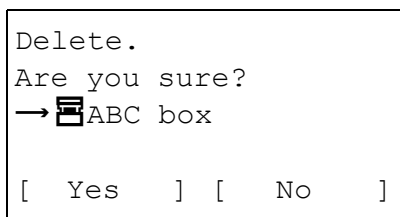

3 Press **[OK]**. A confirmation screen appears.

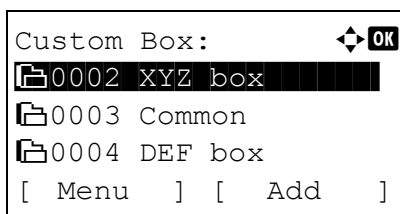

4 To proceed with deleting the custom box, press **[Yes]** (**[Left Select]**). **Completed.** appears and the custom box is deleted. The once deleting of the custom box ends, the **Custom Box** list screen reappears.

Pressing **[No]** (**[Right Select]**) returns to the file list screen without deleting the custom box.

Sorting the Custom Box list

When user login administration is enabled, it is possible to sort the list display into either Box Number order or Box Owner order.

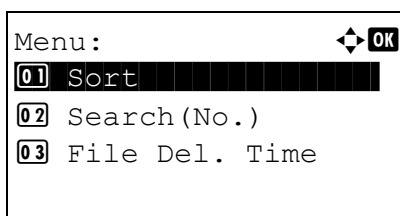

1 In the **Custom Box** list screen, press **[Menu]** (**[Left Select]**). The **Menu** screen appears.

2 Press Δ or ∇ to select **Sort**.

3 Press **[OK]**. The **Sort** screen appears.

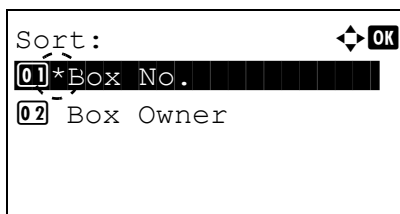

4 Press Δ or ∇ to select **Box No.** or **Box Owner**.

5 Press **[OK]**. The **Menu** screen reappears.

Searching Custom Boxes

It is possible to search for a Custom Box using either the Box number or Box name.

```

Menu:
01 Sort
02 Search(No.)
03 File Del. Time
  
```

- 1 In the Custom Box list screen, press [Menu] (**[Left Select]**). The Menu screen appears.

```

Search(No.):
(0001 - 1000)
0003
[ Menu ]
  
```

- 2 Press Δ or ∇ to select Search (No.) or Search (Name).
- 3 Press **[OK]**. The Search (No.) screen or the Search (Name) screen appears.

Searching is possible using the methods below:

- Searching with Box numbers...5-14
- Searching with Box names...5-14

Searching with Box numbers

```

Menu:
01 *Search(No.)
02 Search(Name)
  
```

- 1 In the Search (No.), press [Menu] (**[Left Select]**). The Menu screen appears.

```

Search(No.):
(0001 - 1000)
0003
[ Menu ]
  
```

- 2 Press Δ or ∇ to select Search (No.).
- 3 Press **[OK]**. The Search (No.) screen appears.

- 4 Enter the Box number to be found and press **[OK]**. A search is done for the Box number entered.

Searching with Box names

```

Menu:
01 *Search(No.)
02 Search(Name)
  
```

- 1 In the Search (No.), press [Menu] (**[Left Select]**). The Menu screen appears.

- 2 Press Δ or ∇ to select Search (Name).

```

Search (Name) :
Box03
ABC
[ Menu ] [ Text ]
  
```

3 Press **[OK]**. The Search (Name) screen appears.

4 Enter the Box name to be found and press **[OK]**. A search is done for the Box name entered.



Note Refer to *Character Entry Method* on page A-2 for details on entering characters.

Setting automatic document deletion for Custom Boxes

Set the time for documents stored in Custom Boxes to be automatically deleted.

```

Menu:
01 Sort
02 Search (No.)
03 File Del. Time
  
```

1 In the Custom Box list screen, press **[Menu]** (**[Left Select]**). The Menu screen appears.

2 Press Δ or ∇ to select File Del. Time.

3 Press **[OK]**. The File Del. Time screen appears.

```

File Del. Time:
Hour   Min.
00    : 00
  
```

4 Use the numeric keys or press Δ or ∇ to enter the hours and minutes.

Press Δ or ∇ to increase or decrease the figures.

Use \triangleleft and \triangleright to move the position being entered, which is shown highlighted.

5 Press **[OK]**. The Menu screen reappears.

File operations (Printing, deleting and moving files)

It is possible to print files stored in a Custom Box, to delete them or to move them to a different Custom Box.

The following operations are possible:

- Box number/Box name (Select a File)...5-16
- Select/Deselect All Files...5-16
- Print a File...5-17
- Print a File (Changes to the print settings)...5-18
- Delete a File...5-22
- Moving files...5-22
- Check File Details...5-23

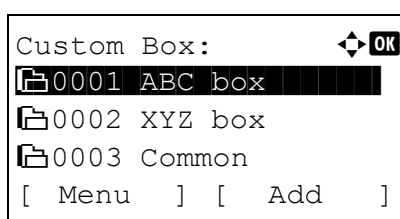

- 1 In the Custom Box list screen, press Δ or ∇ to select a Custom Box.

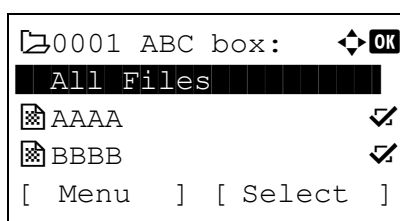

- 2 Press **[OK]**. The printer displays a list of files stored in the Custom Box.

 **Note** If the screen for entering a password is displayed then enter the password using the numeric keys and then press **[OK]**.

Refer to *Character Entry Method* on page A-2 for details on entering characters.

Box number/Box name (Select a File)

To print/delete a file in the Custom Box, first select the file to be printed or deleted.

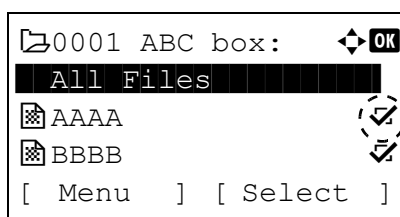

- 1 Press Δ or ∇ to select the file to be printed/deleted.
- 2 When **[Select]** (**[Right Select]**) is pressed, the file is selected. A checkmark will be placed on the right of the selected file.
Select the checkmarked file and press **[Select]** (**[Right Select]**) again to cancel the selection.

 **Note** To select all files, follow the steps of *Select/Deselect All Files* on page 5-16.

Select/Deselect All Files

All files in the Custom Box are selected.

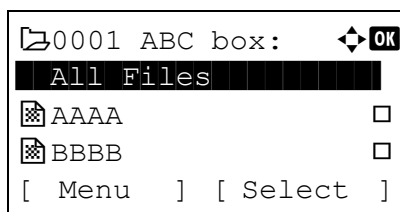

- 1 In the file list screen, press Δ or ∇ to select All Files.

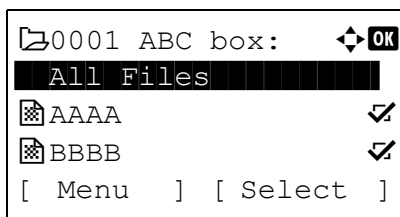

2 Press [Select] (**[Right Select]**).

When there is a file not checked in the Custom Box, all files will be checkmarked.

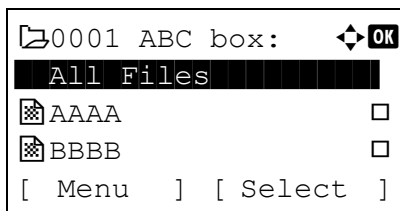

When all files in the Custom Box are checked, all checkmarked files are deselected.

Print a File

Print the file(s) selected in the Custom Box.

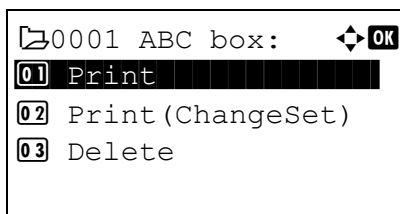

1 In the file list screen, select the item and press **[OK]**. The *Print/Delete* menu screen appears.

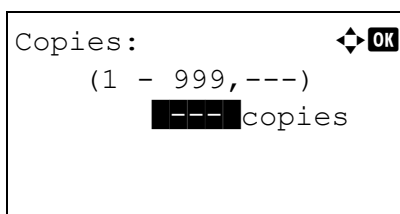

2 Press Δ or ∇ to select *Print*.

3 Press **[OK]**. The *Copies* menu screen appears.

If you want to change the number of remaining copies to be printed, use the numeric keys or press Δ or ∇ to set the number of copies to be printed.



Note If Job Accounting is enabled, enter the account ID in the login screen that appears. The *Copies* menu screen appears after login.

--- is displayed first, and it means it according to the set number of copies when the data of each file is preserved. In this setting, each set number of copies is printed.

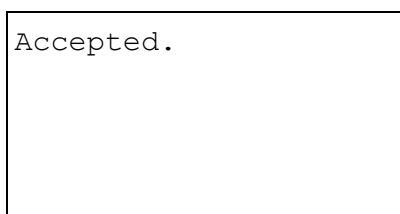

4 Press **[OK]**. The message *Accepted.* appears and printing begins. When *On* is selected in the *Del. afterPrint (Setting for file deletion after printing)* on page 5-11, the selected file will be deleted from the Custom Box after it is printed.

Print a File (Changes to the print settings)

To change the print settings for a file selected in a Custom Box and print it.

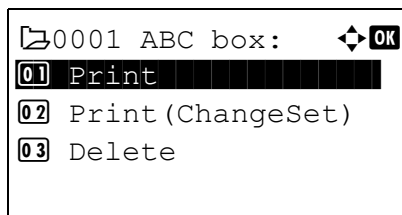

- 1 In the file list screen, select the item and press **[OK]**. The `Print/ Delete` menu screen appears.

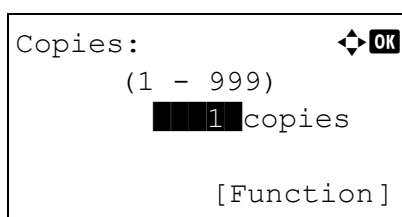

- 2 Press Δ or ∇ to select `Print (ChangeSet)`.
- 3 Press **[OK]**. The `Copies` menu screen appears.

If you want to change the number of remaining copies to be printed, use the numeric keys or press Δ or ∇ to set the number of copies to be printed.



Note If Job Accounting is enabled, enter the account ID in the login screen that appears. The `Copies` menu screen appears after login.

`[Function]` (**[Right Select]**) can be pressed to change the print settings. For details, refer to *Print Function Settings* on page 5-18.

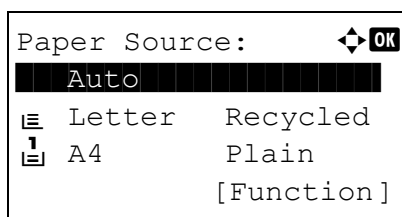

- 4 Press **[OK]**. The `Paper Source` menu screen appears.

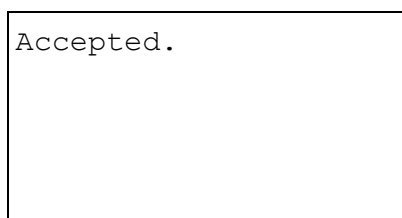

- 5 Press Δ or ∇ to select the tray containing the paper you want to use.
- 6 Press **[OK]**. The message `Accepted.` appears and printing begins. When `On` is selected in the *Del. afterPrint (Setting for file deletion after printing)* on page 5-11, the selected file will be deleted from the Custom Box after it is printed.

Print Function Settings

When printing, the print settings can be changed.

Options available in Print Function Settings are as follows:

- Duplex (Setting the duplex printing)...5-19
- EcoPrint (Selecting the EcoPrint mode)...5-19
- File Name Entry (entering a file name)...5-20
- JobFinish Notice (Settings for notification when jobs are finished)...5-20
- Del. after Print (Delete data after printing setting)...5-21

Duplex (Setting the duplex printing)

Set duplex printing. For details, refer to *Duplex (Setting the duplex printing)* on page 4-41.

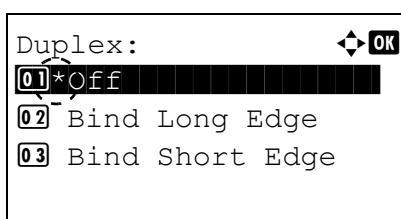
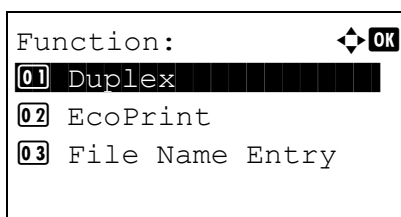

- 1 In the **Copies** menu or the **Paper Selection** menu, press [Function] (**[Right Select]**). The **Function** menu appears.
- 2 Press Δ or ∇ to select **Duplex**.
- 3 Press **[OK]**. The **Duplex** screen appears showing the list of available duplex printing modes.
- 4 Press Δ or ∇ to select the desired duplex printing mode. The message display toggles through the following:
 - Off (default)
 - Bind Long Edge
 - Bind Short Edge
 Selecting **Off** disables duplex printing.
- 5 Press **[OK]**. The duplex printing mode is set and the **Function** menu reappears.

EcoPrint (Selecting the EcoPrint mode)

Set EcoPrint mode. For details, refer to *EcoPrint (Selecting the EcoPrint mode)* on page 4-48.

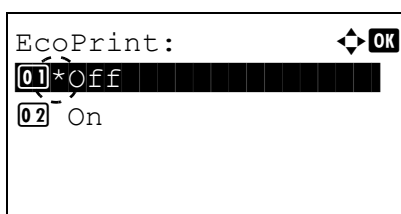
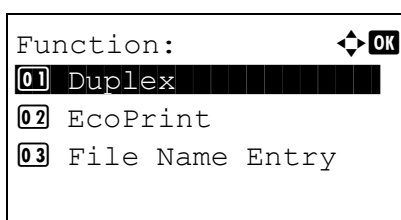

- 1 In the **Copies** menu or the **Paper Selection** menu, press [Function] (**[Right Select]**). The **Function** menu appears.
- 2 Press Δ or ∇ to select **EcoPrint**.
- 3 Press **[OK]**. The **EcoPrint** screen appears.
- 4 Press Δ or ∇ to select the **EcoPrint** mode.
- 5 Press **[OK]**. The **EcoPrint** mode is set and the **Function** menu reappears.

File Name Entry (entering a file name)

Enter the file name. The file name entered is displayed as the Job Name in the Job Status and Job Log.

Function: 

01 Duplex

02 EcoPrint

03 File Name Entry

File Name Entry: 

doc

▲

ABC

[Text]

Additional Info.: 

04 *Job No. + Date

05 Date + Job No.

1 In the **Copies** menu or the **Paper Selection** menu, press [Function] (**[Right Select]**). The **Function** menu appears.

2 Press Δ or ∇ to select **File Name Entry**.

3 Press **[OK]**. The **File Name Entry** screen appears.

4 Enter the file name using the numeric keys.



Note Up to 32 characters can be entered.

Refer to *Character Entry Method* on page A-2 for details on entering characters.

5 Press **[OK]**. The **Additional Info.** screen appears.

6 Press Δ or ∇ to select from the additional information that can be set for the file name.

The following settings can be selected.

- None (No additional information is added.)
- Date (To add the date.)
- Job No. (To add the Job Number.)
- Job No. + Date (To add the Job Number and date.)
- Date + Job No. (To add the date and Job Number.)

7 Press **[OK]**. Register the file name and the **Function** menu reappears.

JobFinish Notice (Settings for notification when jobs are finished)

The end of a job is notified using E-mail.



Note To send E-mail on this machine, set the SMTP and POP3 settings to **On**. For details, refer to *Protocol Detail (Detailed settings for the network protocol)* on page 4-60.

A mail server must be registered. For the method for setting a server, refer to the *Command Center RX User Guide*.

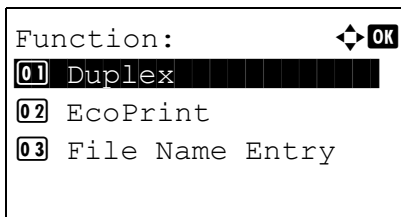

1 In the Copies menu or the Paper Selection menu, press [Function] (**[Right Select]**). The Function menu appears.

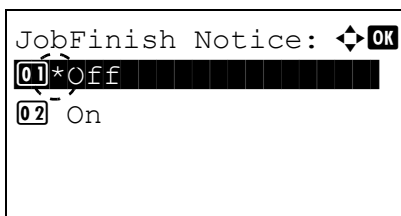

2 Press Δ or ∇ to select JobFinish Notice.
 3 Press **[OK]**. The JobFinish Notice screen appears.

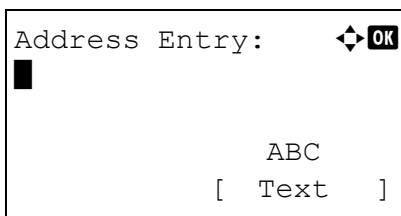

4 Press Δ or ∇ to select On.
 5 Press **[OK]**. The Address Entry screen appears.

6 Enter the E-Mail address to be notified.



Note Up to 128 characters can be entered.
 Refer to *Character Entry Method on page A-2* for details on entering characters.

When user login administration is set, the address of the logged in user is entered.

7 Press **[OK]**. Register the address and the Function menu reappears.

Del. after Print (Delete data after printing setting)

Use this setting to specify whether or not the file data is deleted after printing.

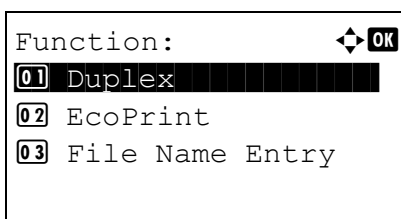

1 In the Copies menu or the Paper Selection menu, press [Function] (**[Right Select]**). The Function menu appears.

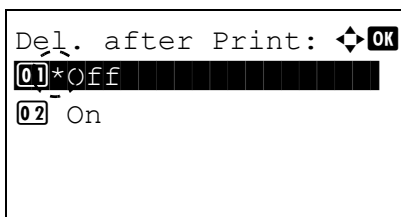

2 Press Δ or ∇ to select Del. after Print.
 3 Press **[OK]**. The Del. after Print screen appears.

4 Press Δ or ∇ to select the Del. after Print setting.

- 5 Press **[OK]**. The Del. after Print setting is set and the Function menu reappears.

Delete a File

Delete the file(s) selected in the Custom Box.

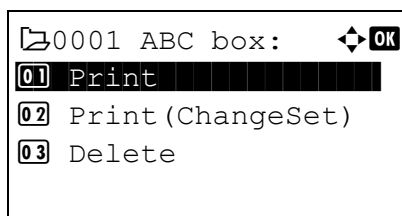

- 1 In the file list screen, select the item and press **[OK]**. The Print/Delete menu screen appears.

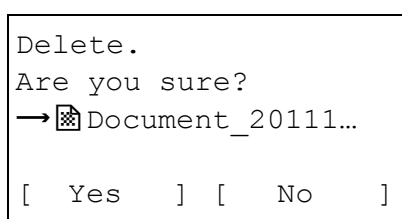

- 2 Press Δ or ∇ to select Delete.
- 3 Press **[OK]**. A confirmation screen appears.

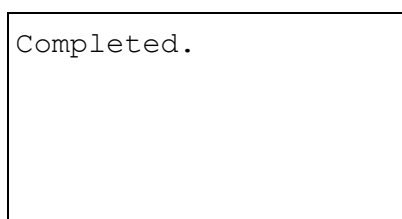

- 4 Press [Yes] (**[Left Select]**). The message Completed. appears and the selected file(s) are deleted.
Pressing [No] (**[Right Select]**) returns to the file list menu screen without deleting the file.

Moving files

A file can be moved to a different Custom Box.

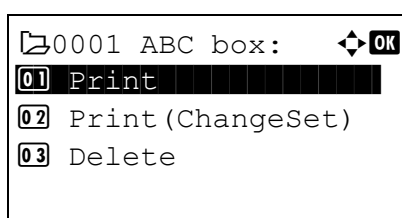

- 1 In the file list screen, select the item and press **[OK]**. The Print/Delete menu screen appears.

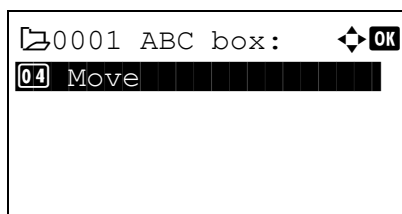

- 2 Press Δ or ∇ to select Move.

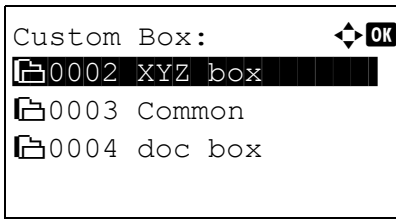

3 Press **[OK]**. The Custom Box list screen appears.

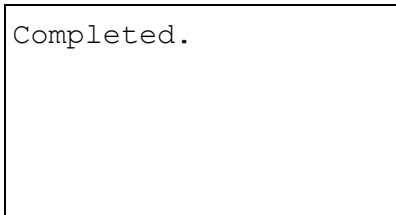

4 Press Δ or ∇ to select the destination Box.

5 Press **[OK]**. The message Completed. appears and the selected file(s) is/are moved.



Note If the screen for entering a password is displayed then enter the password using the numeric keys and then press **[OK]**.

Refer to *Character Entry Method on page A-2* for details on entering characters.

Check File Details

Details for the file that is selected with the cursor will appear.

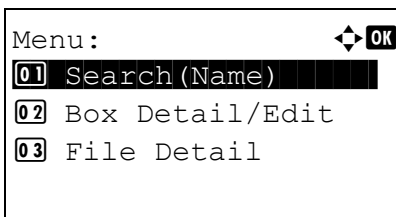

1 In the file list screen, press [Menu] (**[Left Select]**).

2 Press Δ or ∇ to select File Detail.

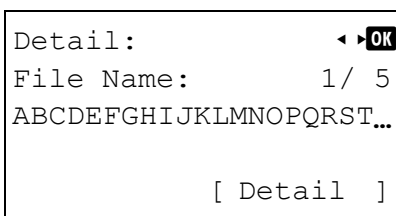

3 Press **[OK]**. Details for the file that is selected with the cursor appears.

The details for the file cover 5 pages in all. Press \triangleright to view to the next page or \triangleleft to return to the previous page.

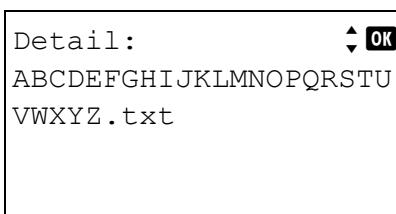

In the File Name screen, if the file name is abbreviated because it cannot be displayed on one line, press [Detail] (**[Right Select]**) to change the display to three lines.

Job Box

IMPORTANT To use the Job Box, an optional SSD (HD-6) or SD/SDHC memory card must be installed in the printer. The RAM disk may also be used in the Proof-and-Hold and Private Print modes.

Job Box is a print function that makes the Job Retention function possible. The settings are specified from the printer driver. Refer to *Computer settings (Printer driver)* on page 5-34 or the *Printer Driver User Guide*.



Note When using the RAM disk to use Job Box, set the RAM disk mode to On.

When using the SSD (HD-6) or an SD/SDHC memory card to use Job Box, set the RAM disk mode to Off. For details, refer to *RAM Disk Setting (Using the RAM disk)* on page 4-81.

Job Retention

Job Retention has four modes as summarized below. These modes are selected from the printer driver through the application software:

	Quick Copy	Proof-and-Hold	Private Print	Stored Job
Primary function	To later print additional copies	To proof the first copy before printing multiple copies	To hold the document in printer to prevent unauthorized access	To electronically store documents such as fax cover pages
Start storing by	Printer driver	Printer driver	Printer driver	Printer driver
On terminating print setting from application software	Prints simultaneously	Prints one copy simultaneously	Does not print	Does not print
Retrieved by	Operation panel	Operation panel	Operation panel	Operation panel
Default number of copies printed at retrieval	Same as storing (can be changed)	One less (can be changed)	Same as storing (can be changed)	One (can be changed)
Maximum number of jobs stored †	300	300	Depends on the SSD or SD/SDHC memory card capacity (the job is automatically deleted after printing)	Depends on the SSD or SD/SDHC memory card capacity
PIN security	No	No	Yes	Yes (if necessary)
Data after printing	Stored	Stored	Deleted	Stored
Data at power off	Deleted	Deleted	Deleted	Stored
SSD (HD-6) or SD/SDHC memory card	Necessary	Unnecessary (RAM disk may also be used)	Unnecessary (RAM disk may also be used)	Necessary

† Jobs in excess will cause the earlier ones to be deleted.



Note Refer to the *Printer Driver User Guide* for the driver settings and print (save) procedures.

Procedure for printing using Job Box

Follow the work flow below when using Job Box.

Specifying the Job Box from a computer and sending the print job (*page 5-34*)



Using the operation panel to specify a file within a Box and printing it

- Quick Copy (*page 5-25*)
- Proof-and-Hold (*page 5-25*)
- Private Print (*page 5-28*)
- Stored Job (*page 5-28*)

Operation panel display

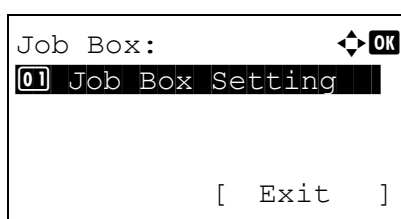

- 1 Press **[Document Box]**. Either the Custom Box list screen or the Job Box menu screen is displayed.



Note After pressing **[Document Box]**, it is possible to display either the Custom Box list screen or the Job Box menu screen or to set them. Refer to *Def. Screen(Box) (Document Box default screen setting)* on *page 4-75*.

If the Custom Box list screen is displayed, follow the procedure below to display the Job Box menu screen.

- 1 Press **[Back]**.
- 2 Press Δ or ∇ to select Job Box.
- 3 Press **[OK]**. The Job Box menu screen appears.

The options available in Job Box are as follows:

- Quick Copy (Using Quick Copy/Proof-and-Hold)...5-25
- Private/Stored (Printing a Private Print/Stored Job)...5-28
- Job Box Setting (Job Box Configuration)...5-32

Quick Copy is displayed if there are any jobs that were saved to the SSD or SD/SDHC memory card in Quick Copy mode.

Quick Copy is also displayed if there are any jobs that were saved to SSD, SD/SDHC memory card or RAM disk in Proof-and-Hold mode.

Private/Stored is only displayed if there are any jobs that were saved to the SSD, SD/SDHC memory card or RAM disk.

Quick Copy (Using Quick Copy/Proof-and-Hold)

Quick Copy mode enables you to print the requested number of copies of a job, simultaneously storing the job on the SSD or SD/SDHC memory card. When additional copies are required, you can reprint the required number of copies from the printer operation panel.

The default number of print jobs that can be stored on the SSD or SD/SDHC memory card is 32. This value can be increased to up to 300. For details, refer to *Job Box Setting (Job Box Configuration)* on *page 5-32*. When the number of jobs reaches the limit, the oldest job will be overwritten by the new one.

When you print multiple copies, Proof-and Hold mode first prints one copy so that you can proof it before continuing to print the remaining copies. Since you can proof the printouts before printing the remaining copies, wastage of paper can be reduced. The printer prints one copy and, at the same time, saves the print job on the SSD, SD/SDHC memory card or RAM disk. You can also change the number of copies when resuming printing from the operation panel.

When the printer is turned off, all stored jobs will be deleted.



Note Refer to the *Printer Driver User Guide* for the driver settings.

The following operations are possible:

- Printing Additional Copies using Quick Copy/Remaining Copies of a Proof-and-Hold Job...5-26
- Select/Deselect All Files...5-26
- Print a File...5-27
- Deleting a Quick Copy/Proof-and-Hold Job...5-27
- Delete a File...5-28

Printing Additional Copies using Quick Copy/Remaining Copies of a Proof-and-Hold Job

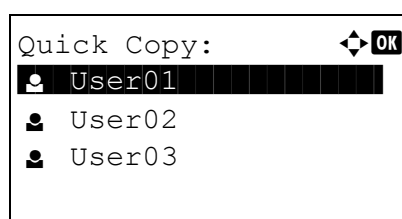

- 1 In the Job Box menu, press Δ or ∇ to select Quick Copy.
- 2 Press **[OK]**. The Quick Copy screen appears listing the user names for stored jobs.

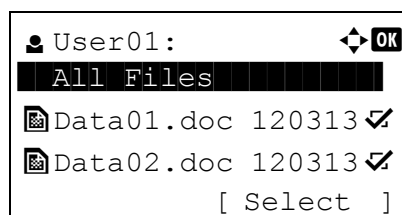

- 3 Press Δ or ∇ to select the user name you entered in the printer driver.
- 4 Press **[OK]**. The printer displays a list of the jobs stored under the selected user name.

- 5 Press Δ or ∇ to scroll to the desired job title.

When **[Select]** (**[Right Select]**) is pressed, the file is selected. A checkmark will be placed on the right of the selected file.

Select the checkmarked file and press **[Select]** (**[Right Select]**) again to cancel the selection.



Note To select all files, follow the steps of *Select/Deselect All Files* on page 5-26

Select/Deselect All Files

All files in the Job Box are selected.

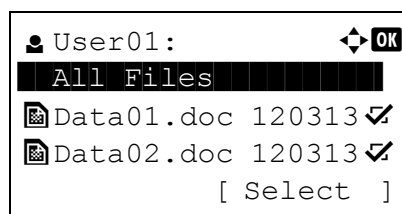

- 1 In the file list screen, press Δ or ∇ to select All Files.

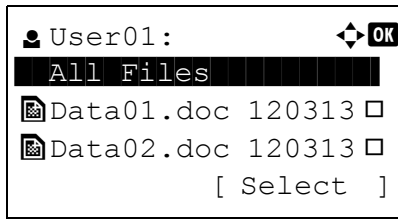

2 Press [Select] ([Right Select]).

When all files in the Job Box are checked, all checkmarked files are deselected.

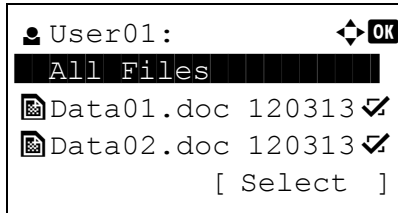

When there is a file not checked in the Job Box, all files will be checkmarked.

Print a File

Print the file(s) selected in the Job Box.

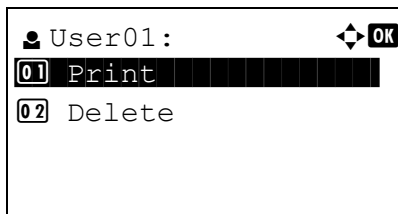

1 In the file list screen, select the item and press [OK]. The Print/Delete menu screen appears.

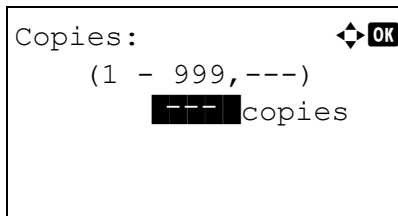

2 Press Δ or ∇ to select Print and press [OK]. The Copies menu screen appears.

To print 2 or more copies, use the numeric keys or press Δ or ∇ to set the number of copies to be printed.



Note --- is displayed first, and it means it according to the set number of copies when the data of each file is preserved. In this setting, each set number of copies is printed.

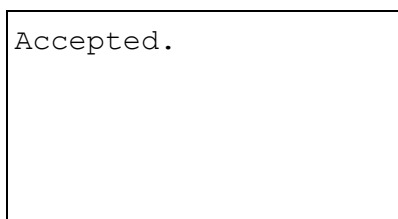

3 Press [OK]. The message Accepted. appears and the printer prints the selected job.

Deleting a Quick Copy/Proof-and-Hold Job

Jobs saved using Quick Copy and Proof-and-Hold are automatically deleted when you turn the printer off, but you can also use this procedure to delete jobs individually.

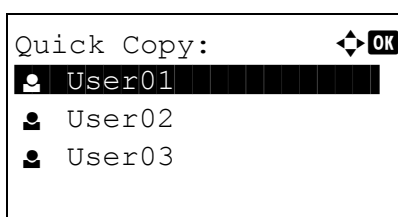

1 In the Job Box menu, press Δ or ∇ to select Quick Copy.

2 Press [OK]. The Quick Copy screen appears listing the user names for stored jobs.

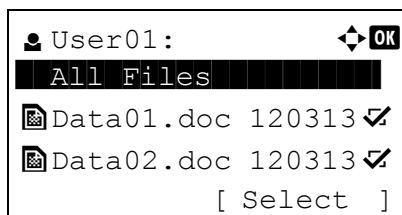

- 3 Press Δ or ∇ to select the user name you entered in the printer driver.
- 4 Press **[OK]**. The printer displays a list of the jobs stored under the selected user name.

- 5 Press Δ or ∇ to select the name of the job to be deleted.
When **[Select]** (**[Right Select]**) is pressed, the file is selected. A checkmark will be placed on the right of the selected file.
Select the checkmarked file and press **[Select]** (**[Right Select]**) again to cancel the selection.



Note To select all files, follow the steps of *Select/Deselect All Files* on page 5-26

Delete a File

Delete the file(s) selected in the Job Box.

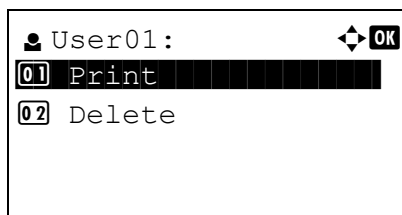

- 1 In the file list screen, select the item and press **[OK]**. The **Print/Delete** menu screen appears.

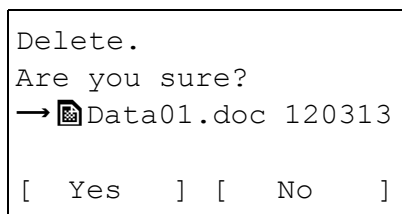

- 2 Press Δ or ∇ to select **Delete** and press **[OK]**. A confirmation message is appears.

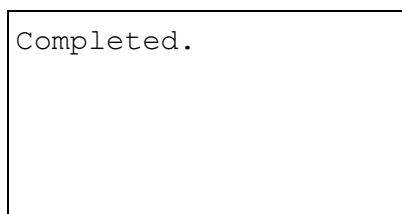

- 3 Press **[Yes]** (**[Left Select]**). The message **Completed.** appears and the printer deletes the selected job.
Pressing **[No]** (**[Right Select]**) returns to the file list screen.

Private/Stored (Printing a Private Print/Stored Job)

In private printing, you can specify that a job is not printed until you release the job from the operation panel. When sending the job from the application software, specify a 4-digit access code in the printer driver. The job is released for printing by entering the access code on the operation panel ensuring confidentiality of the print job.

In the stored job mode, access codes are not mandatory, but can be set on the printer driver if printing with PIN security is required. Then, the access code must be entered on the operation panel to print a stored job. Print data will be stored in the SSD, SD/SDHC memory card or RAM disk after printing.



Note Refer to the *Printer Driver User Guide* for the driver settings.

The following operations are possible:

- Printing a Private/Stored Job...5-29
- Print a File...5-29
- Deleting a Private/Stored Job...5-30
- Delete a File...5-31

Printing a Private/Stored Job

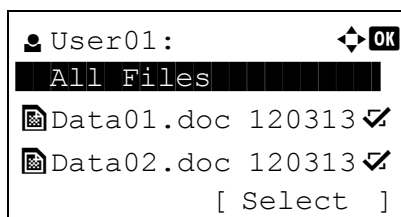
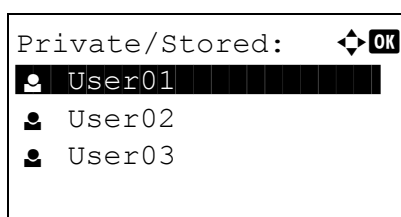

- 1 In the Job Box menu, press Δ or ∇ to select Private/Stored.
- 2 Press **[OK]**. The Private/Stored screen appears listing the user names for stored jobs.

- 3 Press Δ or ∇ to select the user name you entered in the printer driver.

- 4 Press **[OK]**. The printer displays a list of the jobs stored under the selected user name.

- 5 Press Δ or ∇ to select the name of the job to be printed.

When **[Select]** (**[Right Select]**) is pressed, the file is selected. A checkmark will be placed on the right of the selected file.

Select the checkmarked file and press **[Select]** (**[Right Select]**) again to cancel the selection.



Note To select all files, follow the steps of *Select/Deselect All Files* on page 5-26

Print a File

Print the file(s) selected in the Job Box.

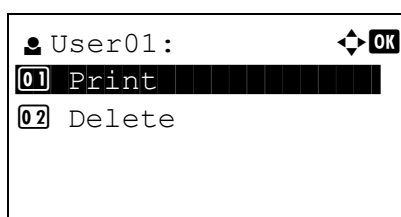

- 1 In the file list screen, select the item and press **[OK]**. The Print/Delete menu screen appears.

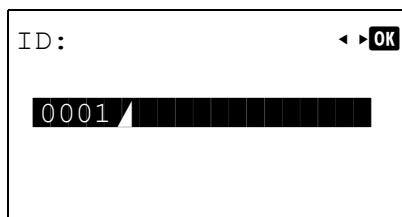

- Press Δ or ∇ to select `Print` and press **[OK]**. If the selected job was saved as a Private Print job, its `ID` is displayed. If the job was saved in stored job mode, the number of direct copies is displayed.

- Use the numeric keys to enter the access code entered in the printer driver.

Press **[OK]**. If the entered access code is correct, the `Copies` menu screen appears.

If the entered access code is incorrect, the `ID` menu screen reappears.



Note When the access code is set to the document selected in the check box, `Incorrect ID` is displayed for the disagreement.

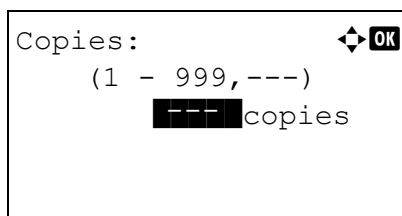

- To print 2 or more copies, use the numeric keys or press Δ or ∇ to set the number of copies to be printed.

After selecting the multiple copies in the printer driver, you can also restore to "1" from the operation panel using the same method.



Note --- is displayed first, and it means it according to the set number of copies when the data of each file is preserved. In this setting, each set number of copies is printed.

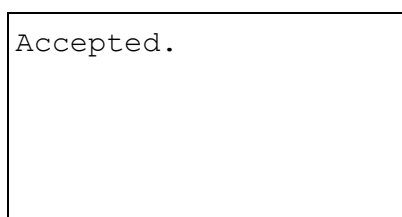

- Press **[OK]**. The message `Accepted.` appears and the printer prints the selected job.

Deleting a Private/Stored Job

You can individually delete stored jobs by performing the following procedure. Jobs saved using Private Print will be automatically deleted when you turn the power off, or after printing, but jobs saved using Stored Job will not be deleted automatically.

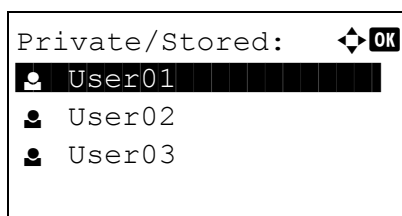

- In the `Job Box` menu, press Δ or ∇ to select `Private/Stored`.

- Press **[OK]**. The `Private/Stored` screen appears listing the user names for stored jobs.

- Press Δ or ∇ to select the user name you entered in the printer driver.

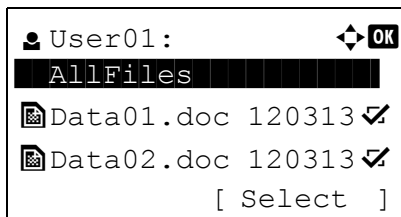

- 4 Press **[OK]**. The printer displays a list of the jobs stored under the selected user name.

- 5 Press Δ or ∇ to select the name of the job to be printed. When **[Select]** (**[Right Select]**) is pressed, the file is selected. A checkmark will be placed on the right of the selected file. Select the checkmarked file and press **[Select]** (**[Right Select]**) again to cancel the selection.

 **Note** To select all files, follow the steps of *Select/Deselect All Files* on page 5-26

Delete a File

Delete the file(s) selected in the Job Box.

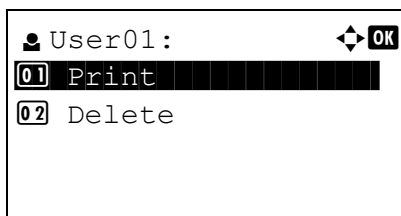

- 1 In the file list screen, select the item and press **[OK]**. The *Print/Delete* menu screen appears.

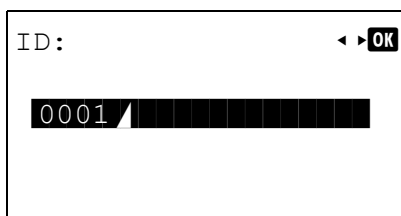

- 2 Press Δ or ∇ to select *Delete* and press **[OK]**. The *ID* is displayed.

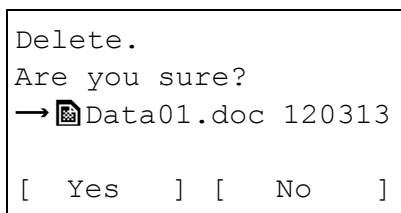

- 3 Use the numeric keys to enter the access code entered in the printer driver.
- 4 Press **[Enter]** (**[Right Select]**). If the entered access code is correct, the *Delete* menu screen appears. If the entered access code is incorrect, the *ID* menu screen reappears.

 **Note** When the access code is set to the document selected in the check box, *ID error* is displayed for the disagreement.

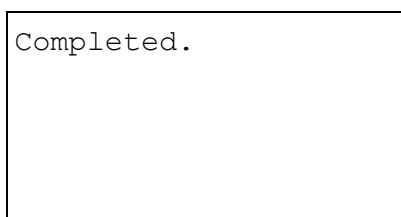

- 5 Press **[Yes]** (**[Left Select]**). *Complete.* appears and the printer deletes the selected job. Pressing **[No]** (**[Right Select]**) returns to the file list screen.

Job Box Setting (Job Box Configuration)

Change Job Box setting, such as the maximum number of storable documents in the SSD or SD/SDHC memory card, and automatic delete settings, and select the storage media.

The following items are available in the Job Box setting.

- Quick Copy Jobs (Changing the Maximum Number of Quick Copy jobs)...5-32
- JobRet. Deletion (Set Automatic Delete times for Temporary Jobs)...5-32
- Storage Media (Selecting the storage media for the jobs)...5-33

Quick Copy Jobs (Changing the Maximum Number of Quick Copy jobs)

This changes maximum number of Quick Copy jobs to a value between 0 and 300. The default is 32.

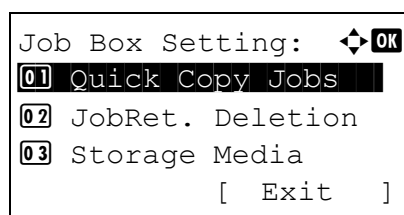

- 1 In the Job Box menu, press Δ or ∇ to select Job Box Setting.
- 2 Press **[OK]**. The Job Box Setting screen appears.

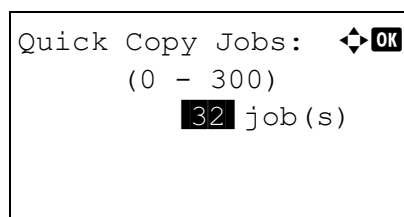

- 3 Press Δ or ∇ to select Quick Copy Jobs and press **[OK]**. The Quick Copy Jobs screen appears.
- 4 Use the numeric keys or Δ or ∇ to set the maximum number of Quick Copy jobs.

- 5 Press **[OK]**. The setting is stored and the Job Box Setting menu reappears.

JobRet. Deletion (Set Automatic Delete times for Temporary Jobs)

When the set period passes, the temporary jobs are automatically deleted.

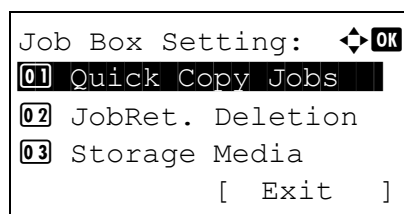

- 1 In the Job Box menu, press Δ or ∇ to select Job Box Setting.
- 2 Press **[OK]**. The Job Box Setting screen appears.

- 3 Press Δ or ∇ to select JobRet. Deletion and press **[OK]**. The JobRet. Deletion screen appears.

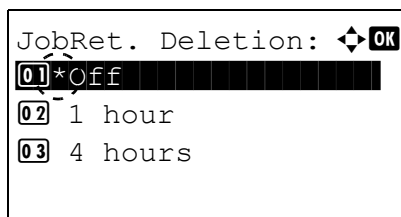

- 4 Press Δ or ∇ to select the desired Automatic Delete time. The list shows the following times:

Off (automatic delete is not performed)

1 hour (deleted in 1 hour)

4 hours (deleted in 4 hours)

1 day (deleted on the next day)

1 week (deleted after one week)

- 5 Press **[OK]**. The setting is stored and the Job Box Setting menu reappears.

Storage Media (Selecting the storage media for the jobs)

If the optional SSD and SD/SDHC memory card are both installed, it is possible to select which storage media to use.



Note After this setting has been done, turn the machine **OFF** and **ON** again. This is mandatory to make the settings effective.

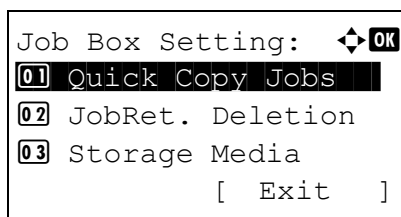

- 1 In the Job Box menu, press Δ or ∇ to select Job Box Setting.
- 2 Press **[OK]**. The Job Box Setting screen appears.

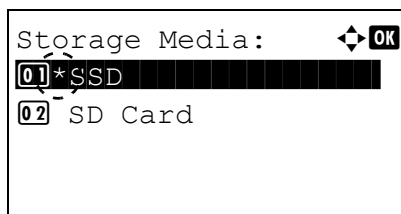

- 3 Press Δ or ∇ to select Storage Media and press **[OK]**. The Storage Media screen appears.
- 4 Press Δ or ∇ to select the desired storage media. The list shows the following media:

SSD

SD Card

- 5 Press **[OK]**. The setting is stored and the Job Box Setting menu reappears.

Computer settings (Printer driver)

Use the procedure below to store data in a Custom Box or a Job Box.

- 1 From the application File menu, select **Print**. The Print dialog box displays.
- 2 Click the drop down list of printer names. All the printers installed in Windows are listed. Click the name of the machine.
- 3 Click **Properties**. The Properties dialog box displays.
- 4 Click the **Job** tab and select the **Job storage (e-MPS)** check box to set the function.

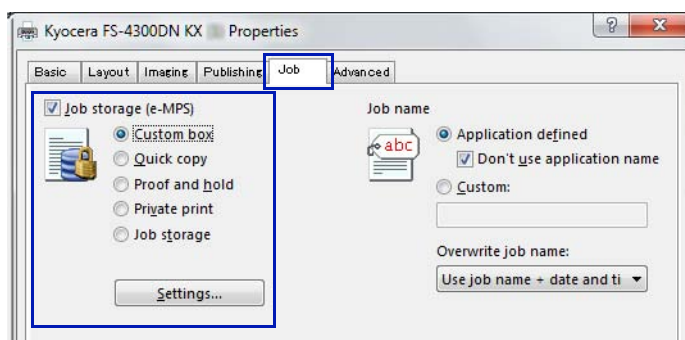

Document Box		Method for setting the printer driver
Custom Box		<ol style="list-style-type: none"> 1 Select Custom box. 2 Click Settings. 3 Select a Custom Box Settings option: <ul style="list-style-type: none"> • Select Use specific box number, and type the box number and password. • Select Prompt for box number, and click OK. When the Custom Box dialog box appears, type a box number from the Defined custom boxes list. If a password was set, type the password. • Select Display box number list, and click OK. When the Custom Box dialog box appears, select a box from the list. If a password was set, type the password. This can be selected if Shared box is selected in the SSD Settings dialog box. • Select Verify box number for each login user, and click OK. When the Custom Box dialog box appears, type a box number. To include a password, select Require password and type the password. This can be selected when Shared box is selected in the SSD Settings dialog box. 4 Click OK to return to the Print dialog box.
Job Box	Quick Copy	Select Quick copy .
	Proof-and-Hold	Select Proof and hold .
	Private Print	Select Private print and set the Access code.
	Stored Job	Select Job storage . Set the Access code if necessary.

 **Note** For information on how to use the printer driver software, refer to the *Printer Driver User Guide*.

6 Status Menu

This chapter contains explanations on the following topics:

Displaying the Status Menu Screen	6-2
Job Status.....	6-2
Job Log.....	6-4
USB Keyboard.....	6-5
Wireless Network.....	6-5

Displaying the Status Menu Screen

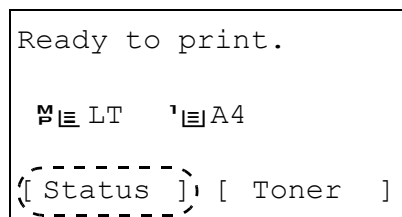

If **Status** is displayed at the left of the bottom row of the message display whilst the machine is printing or awaiting printing, it is possible to display the Status menu screen.

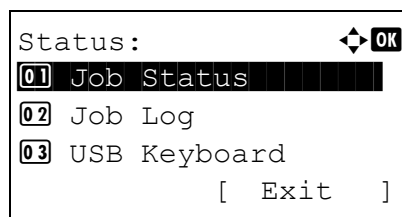

Press [Status] (**Left Select**). The Status menu screen appears.

The following operations are possible on the Status menu screen:

- Job Status...6-2
- Job Log...6-4
- USB Keyboard...6-5
- Wireless Network...6-5



Note USB Keyboard is only displayed when a USB keyboard is connected.

Wireless Network is only displayed when the optional wireless network interface kit (IB-51) is installed.

Job Status

It is possible to check the status of jobs printing or awaiting printing.

In addition to the jobs printed from computers, it is also possible to check reports such as status pages and jobs printed directly from USB memory.

The information available in the Job Status is listed below.

Item	Content	Results Displayed		
		Display	Icon	Description
Job Name	Job name	Job name		Job name
Status	Job status	Processing		Printing
		Pause		Printing suspended
		Canceling		Job canceled.
Job Type	Job type	Printer		Printed from a PC
		Report		Report
		USB		Printed from USB memory
		Box		Printed from Job Box
Accepted Time	Job reception time	Day/Month/Year Hour:Minute [†] Month/Day/Year Hour:Minute [†] Year/Month/Day Hour:Minute [†]		
User Name	Printed user name	User name		
Printed Pages	Pages printed	***Page(s)		No. of pages
		***/**		Copies completed/Copies specified

[†] The display differs depending on the countries or regions.

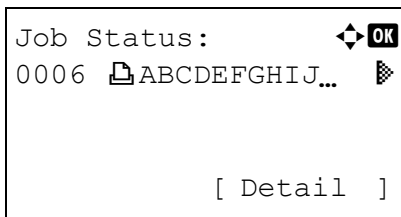

- 1 In the Status menu, press Δ or ∇ to select Job Status.
- 2 Press **[OK]**. Job Status is displayed and a list is displayed of the job numbers and job names of the jobs currently being printed or awaiting printing. Also, the type of job and results are indicated for each job using icons.

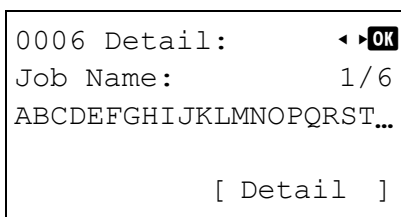

- 3 Press Δ or ∇ to select the name of the job whose details you want to view.
- 4 Press [Detail] (**[Right Select]**). The Detail screen appears.
The detailed job status covers 6 pages in all. Press \triangleright to view to the next page or \triangleleft to return to the previous page.

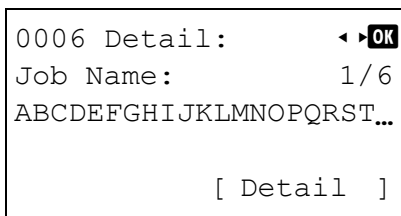

Pressing **[OK]** returns you to the Job Status menu.

If the entire name shown as the Job Name will not fit on one line, pressing [Detail] (**[Right Select]**) changes to a 3-line name display.

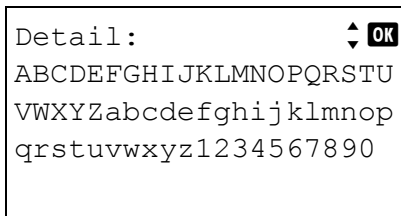

Pressing **[OK]** during 3-line name display returns you to single-line name display.

Job Log

You can use the Job Log to check the history of jobs that have already finished printing.

As well as jobs printed from PCs, this log shows the outcomes for jobs printed directly from USB memory and reports such as status pages.

It is possible to check the log of the 100 most recent jobs.

The information available in the Job Log is listed below.

Item	Content	Results Displayed		
		Display	Icon	Description
Job Name	Job name	Job name		Job name
Result	Job status	OK	OK	Completed normally
		Error		Error occurred.
		Cancel		Job canceled.
Job Type	Job type	Printer		Printed from a PC
		Report		Report
		USB		Printed from USB memory
		Box		Printed from Job Box
Accepted Time	Job reception time	Day/Month/Year Hour:Minute [†] Month/Day/Year Hour:Minute [†] Year/Month/Day Hour:Minute [†]		
User Name	Printed user name	User name		
Printed Pages	Pages printed	***Page(s)		No. of pages
		***/**		Copies completed/Copies specified

[†] The display differs depending on the countries or regions.

- 1 In the Status menu, press Δ or ∇ to select Job Log.
- 2 Press **[OK]**. Job Log is displayed, along with the job numbers of completed jobs and a list of the job names. The job type and result for each job are also shown as icons.
- 3 Press Δ or ∇ to select the name of the job whose details you want to view.
- 4 Press [Detail] (**[Right Select]**). The Detail screen appears.
The detailed job log covers 6 pages in all. Press \triangleright to view to the next page or \triangleleft to return to the previous page.
Pressing **[OK]** returns you to the Job Log menu.

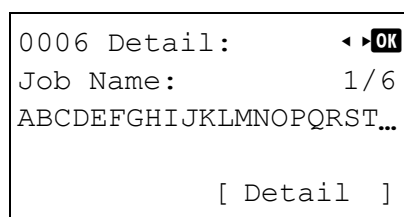
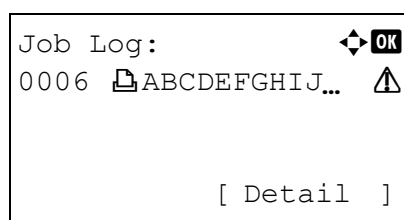

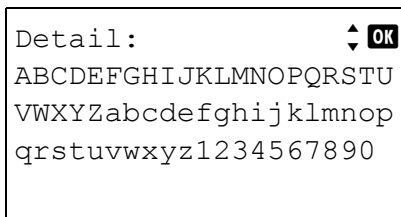

If the entire name shown as the Job Name will not fit on one line, pressing [Detail] ([Right Select]) changes to a 3-line name display.

USB Keyboard

When a USB keyboard is attached, it is possible to check whether the USB keyboard can be used.

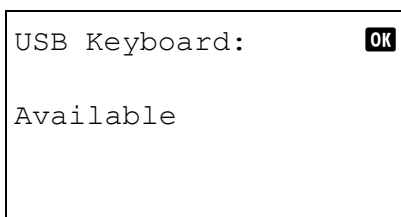

- 1 In the Status menu, press Δ or ∇ to select USB Keyboard.
- 2 Press [OK]. If the USB keyboard is available for use, Available is displayed.

Wireless Network

When the optional wireless network interface kit is installed, it is possible to check the status of the wireless network.



Note Wireless Network is only displayed when the optional wireless network interface kit is installed.

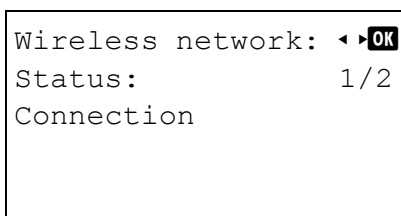

- 1 In the Status menu, press Δ or ∇ to select Wireless network.
- 2 Press [OK]. The status of the wireless network is displayed.

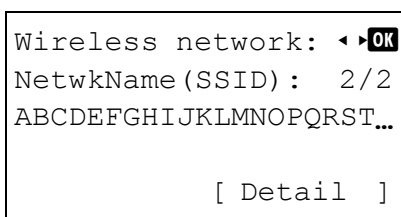

- 3 Press \triangleleft or \triangleright . The NetwkName (SSID) is displayed.

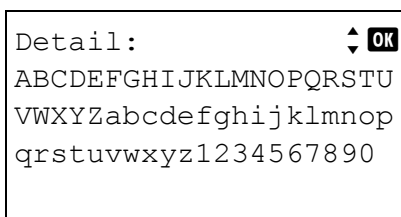

If the entire name shown as the NetwkName (SSID) will not fit on one line, pressing [Detail] ([Right Select]) changes to a 3-line name display.

7 Maintenance

This chapter contains explanations on the following topics:

Toner Container Replacement	7-2
Replacing the Waste Toner Box	7-6
Cleaning the Printer.....	7-8

Toner Container Replacement

The printer displays messages at two stages of toner usage:

- When the printer becomes low on toner, the printer displays the message `Toner is running out.` as the first caution. Note the replacement is not always necessary at this stage. Prepare the new toner kit.
- If you ignore the above message and continue printing, the printer displays the message `Replace the toner.` - just before the toner is used up. The printer will stop printing. The toner container must be replaced immediately. Refer to *Replacing the Toner Container on page 7-3.*

Frequency of Toner Container Replacement

The life of the toner containers depends on the amount of toner required to accomplish your printing jobs. According to ISO/IEC 19752 and EcoPrint switched off the toner container can print as follows (A4/Letter paper is assumed): 12,500 images (FS-2100D and FS-2100DN), 15,500 images (FS-4100DN), 21,000 images (FS-4200DN for the U.S.A.) or 25,000 images (FS-4200DN for destination other than the U.S.A. and FS-4300DN).

Starter Toner Container

The toner container packed with the new printer is a starter toner container. The starter toner container lasts an average of 6,000 images (FS-2100D and FS-2100DN), 8,000 images (FS-4100DN), or 10,000 images (FS-4200DN and FS-4300DN).

 **Note** Information Collection on Memory Chips - The memory chip attached to the toner container is designed to improve convenience for the end user; to support the recycling operation of empty toner containers; and to gather information to support new product planning and development. The information gathered is anonymous - it cannot be associated to any specific individual and the data is intended to be used anonymously.

Toner Kits

For best results, we recommend that you only use genuine Kyocera Parts and Supplies. Should any damage be caused by the application of a toner other than the original toner, then this damage is excluded from the guarantee.

A new toner kit contains the following items:

- Toner Container
- Plastic waste bags for old toner container and old waste toner box
- Waste Toner Box
- Installation Guide

 **Note** Do not remove the toner container from the carton until you are ready to install it in the printer.

Replacing the Toner Container

This section explains how to replace the toner containers. When replacing the toner container, always replace the waste toner box at the same time. If this box is full, the printer may be damaged or contaminated by the waste toner that may spill over the box.



CAUTION Do not attempt to incinerate the Toner Container. Dangerous sparks may cause burns.

IMPORTANT During toner container replacement, temporarily move storage media and computer supplies (such as floppy disks and USB memories) away from the toner container. This is to avoid damaging media by the magnetism of toner.

IMPORTANT Always clean the inside of the printer after replacing the toner cartridge. For details, refer to *Cleaning the Printer* on page 7-8.

IMPORTANT Kyocera Document Solutions Inc. is not liable against any damages or problems arising from the use of toner containers other than those designated as original Kyocera toner containers. For optimum performance, it is also recommended to use only the Kyocera toner containers which are specifically intended for use in your country or region. If the toner container for another destination is installed, the printer will stop printing.

IMPORTANT Before replacing the toner container, remove the paper on the MP tray.



Note You do not have to turn printer power off before starting the replacement. Any data that may be processing in the printer will be deleted if you turn the printer power off.

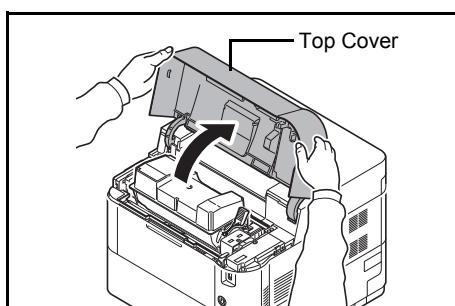

1 Open the top cover.

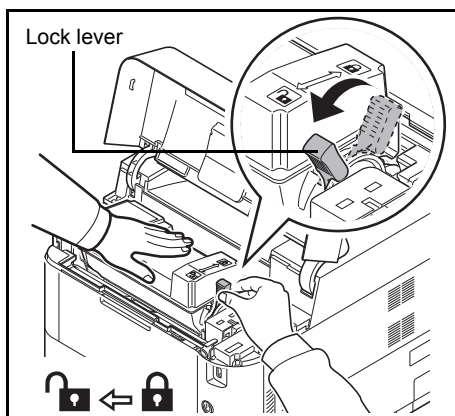

2 Turn the lock lever to the unlock position.

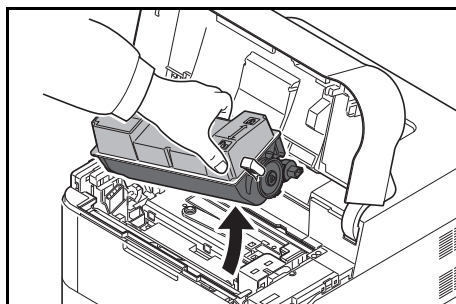

3 Carefully remove the old toner container from the printer.

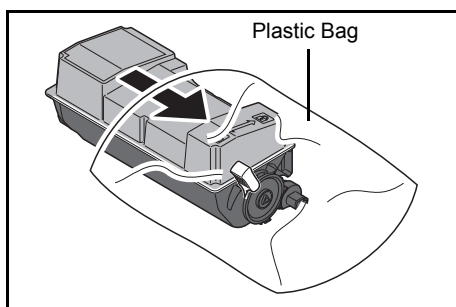

4 Put the old toner container in the plastic bag (contained in the toner kit) and discard it later according to the local code or regulations for waste disposal.

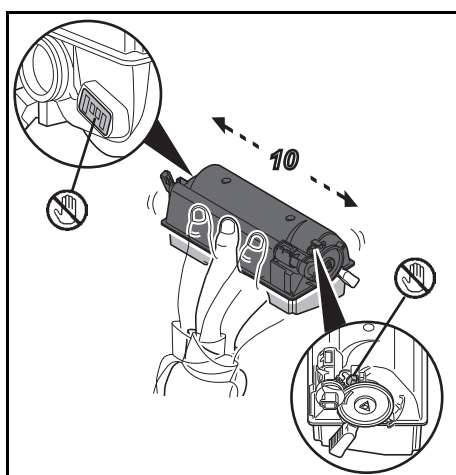

5 Take the new toner container out of the toner kit.

6 Shake the new toner container at least 10 times as shown in the figure in order to distribute the toner evenly inside the container. Do not press too firmly on the center of the toner container or touch the toner feed slot.

IMPORTANT Do not touch the part of the toner container indicated on the diagram. Do not touch the electrical parts of the toner container to avoid damaging them by static electricity.

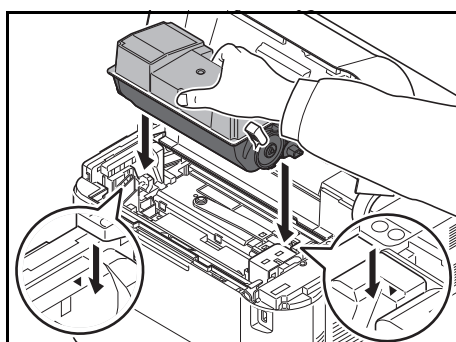

7 Set the new toner container in the printer as shown in the figure.

8 Push down on the top of the toner container to install it firmly in place.

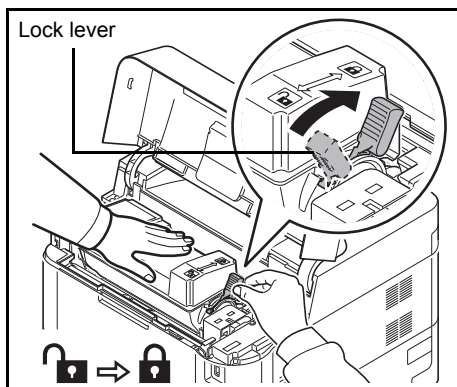

9 Turn the lock lever to the lock position.

10 Close the top cover.



Note If the top cover (top tray) does not close, check that the new toner container is installed correctly (in step 7). After use, always dispose of the toner container and the waste toner box in accordance with Federal, State and Local rules and regulations.

Proceed to the next section.

Replacing the Waste Toner Box

Replace the waste toner box when the `Check waste toner box.` Message is displayed. A new waste toner box is included with the toner kit. The waste toner box needs to be replaced before the printer will operate.

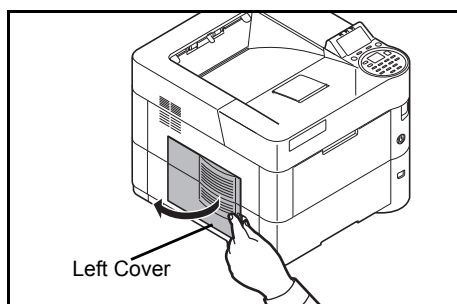

- 1 Open the left cover.

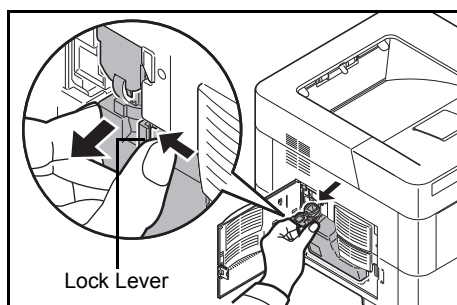

- 2 While holding the waste toner box, press the lock lever and then gently remove the waste toner box.



Note Remove the waste toner box as gently as possible so as not to scatter the toner inside. Do not let the opening of the waste toner box face downward.

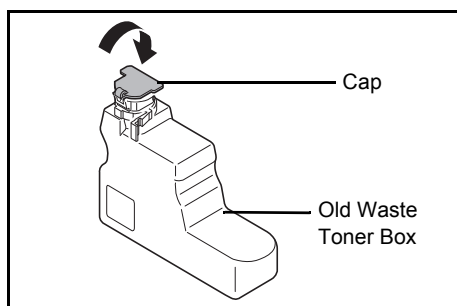

- 3 Close the cap to the old waste toner box after removing the box from the printer.

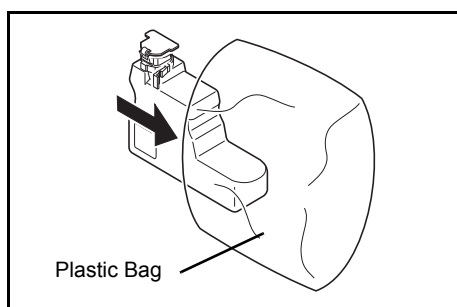

- 4 To prevent toner from spilling, put the old waste toner box in the plastic bag (contained in the toner kit) and discard it later according to the local code or regulations for waste disposal.

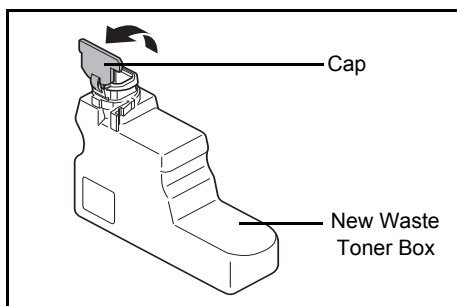

- 5** Open the cap of the new waste toner box.

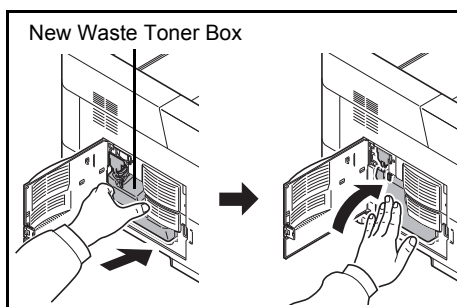

- 6** Insert the new waste toner box as shown in the figure. When the box is set correctly, it will snap into place.

- 7** Make sure that the waste toner box is correctly inserted and close the left cover.

After replacing the toner containers and the waste toner box, clean the paper transfer unit. For instructions, refer to *Cleaning the Printer on page 7-8*.

Cleaning the Printer

To avoid print quality problems, the interior of the printer must be cleaned with every toner container replacement.

IMPORTANT Before cleaning the printer, remove the paper on the MP tray.

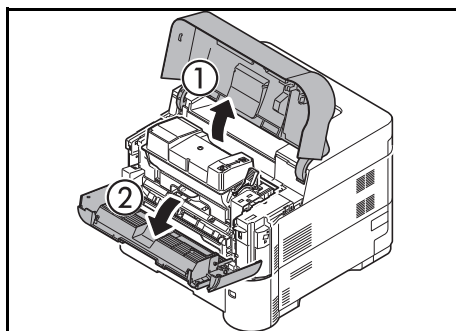

- 1 Open the top cover and front cover.

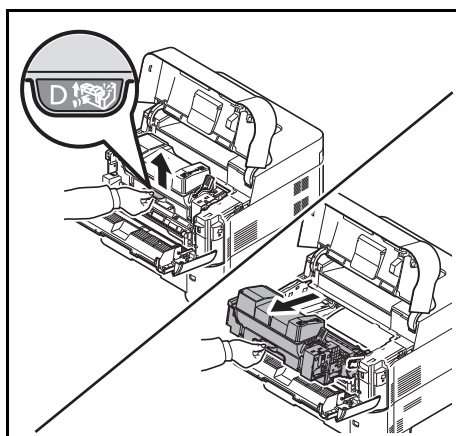

- 2 Pull the developer unit together with the toner container.

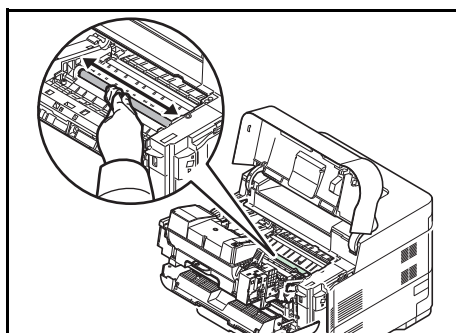

- 3 Use a lint free cloth to clean dust and dirt away from the registration roller (metal).

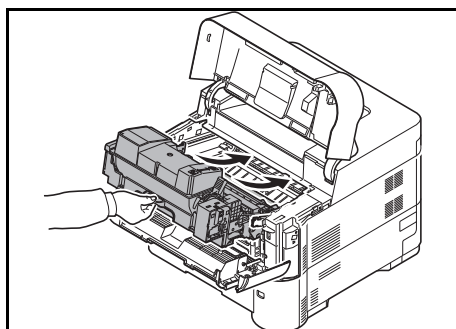

- 4 Insert the developer unit together with the toner container, back into the machine.

- 5 Close the front cover and top cover.

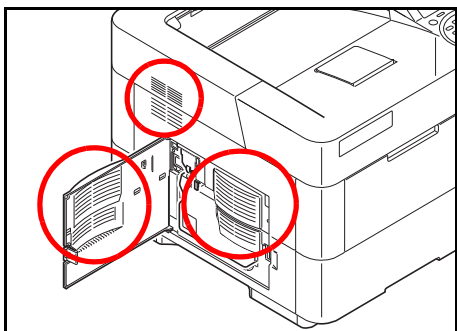

6 Open the left cover. Use a lint free cloth to clean dust and dirt away from the vents.

7 Close the left cover.

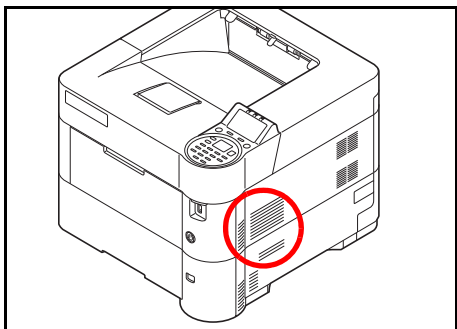

8 Use a lint free cloth to clean dust and dirt away from the vent on the right side of the machine.

Prolonged Non-Use and Moving of the Printer

Prolonged Non-use

If you ever leave the printer unused for a long period of time, remove the power cord from the wall outlet.

We recommend you consult with your dealer about the additional actions you should take to avoid possible damage that may occur when the printer is used next time.

Moving the Printer

When you move the printer:

- Move it gently.
- Keep it as level as possible to avoid spilling toner inside the printer.
- Be sure to consult a service technician before attempting long distance transportation of the printer
- Keep the printer horizontal.



WARNING If you ship the printer, remove and pack the developer unit in a plastic bag and ship them separately from the printer.

8 Troubleshooting

This chapter contains explanations on the following topics:

General Guidelines	8-2
Print Quality Problems	8-3
Error Messages	8-5
Clearing Paper Jams	8-17

If a problem cannot be corrected, contact your service technician.

General Guidelines

The table below provides basic solutions for problems you may encounter with the printer. We suggest you consult this table to troubleshoot the problems before calling for service.

Symptom	Check Items	Corrective Action
Print quality is not good.	Refer to <i>Print Quality Problems on page 8-3</i> .	
Paper is jammed.	Refer to <i>Clearing Paper Jams on page 8-17</i> .	
Nothing lights on the operation panel even when power is turned on and the fan makes no noise.	Check that the power cord is properly plugged into the power outlet.	Plug in the power cord securely, and try turning on the printer's power again. If the corrective action above will not solve the problem, pull out the power cord from the outlet. Wait more than 1 minute, and then plug the power cord into the outlet and try turning on the printer's power again.
	-	Press the power switch.
The printer prints a status page, but does not print jobs from the computer.	Check the printer cable or the interface cable.	Connect both ends of the printer cable securely. Try replacing the printer cable or the interface cable.
	Check program files and application software.	Try printing another file or using another print command. If the problem occurs only with a specific file or application, check the printer driver settings for that application.
The printer is emitting steam in the area around the top tray.	Check the room temperature to see if it is low, or if damp paper was used.	Depending on the printing environment and the paper's condition, the heat generated during printing will cause the moisture in the paper to evaporate, and the steam emitted may look like smoke. This is not a problem, and you can continue printing. If the steam concerns you, raise the room temperature, or replace the paper with a newer, dryer paper.

Tips

Printer problems may be solved easily by following the tips below. When you have encountered a problem that following the above guidelines will not solve, try the following:

- Turn the printer power off and wait for several seconds. Then, turn on the printer.
- Reboot the computer which sends the print jobs to the printer.
- Obtain and use the latest version of the printer driver. The latest versions of printer drivers and utilities are available at: <http://www.kyoceradocumentsolutions.com>.
- Make sure that the procedures for printing are correctly followed in the application software. Consult the documentation supplied with the application software.

Print Quality Problems

The tables and diagrams in the following sections define print quality problems and the corrective action you can conduct to solve the problems. Some solutions may require cleaning or replacing parts of the printer.

If the suggested corrective action will not solve the problem, call for service.

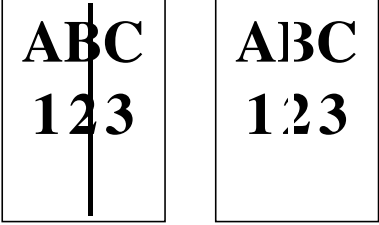
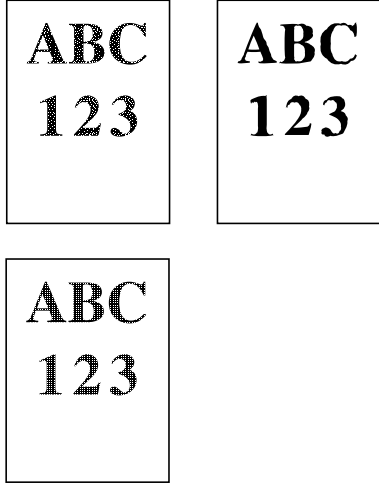
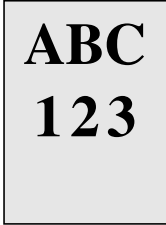
Printed Results	Corrective Action
<p>Black or white vertical streaks</p> 	<p>The drum unit or developer unit may be damaged. If the problem is not solved even after printing several pages, call for service.</p>
<p>Faint or blurred printing</p> 	<p>Check the EcoPrint settings. When this setting is On, switch it to off on the operation panel.</p> <p>Make sure the paper type setting is correct the paper being used.</p> <p>Refresh the drum to restore the printing quality. For more information, refer to <i>Service Setting (for Maintenance)</i> on page 4-128. Then, adjust the print density. For more information, refer to <i>Print Density (Selecting the Print Density)</i> on page 4-49. If the damp paper is loaded into the cassette or MP tray, replace the paper with a newer, dryer paper. If the problem is not solved using the corrective action above, call for service.</p>
<p>Gray background</p> 	<p>Refresh the drum to restore the printing quality. For more information, refer to <i>Service Setting (for Maintenance)</i> on page 4-128. Then, adjust the print density. For more information, refer to <i>Print Density (Selecting the Print Density)</i> on page 4-49. If the problem is not solved using the corrective action above, call for service.</p>

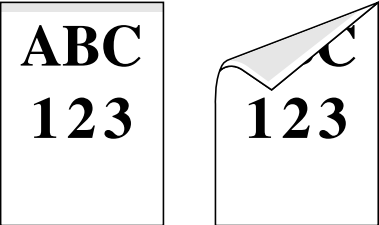
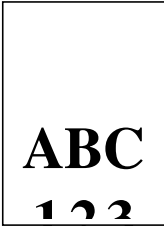
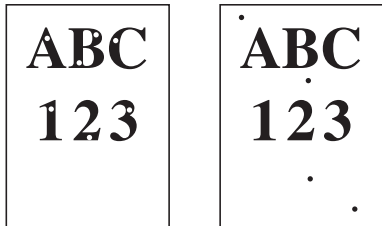
Printed Results	Corrective Action
<p>Dirt on the top edge or back of the paper</p> 	<p>If the problem is not solved even after printing several pages, clean the registration roller. For more information, refer to <i>Cleaning the Printer on page 7-8</i>. If the problem is not solved after cleaning, call for service.</p>
<p>Printing incomplete or out of position</p> 	<p>Check that the application software is correctly operated. Refer to <i>Tips on page 8-2</i>.</p>
<p>The altitude is 1500 m or higher and there are some dropouts or stray dots in the printouts.</p> 	<p>Change the Altitude Adj. setting in <i>Service Setting</i> menu to High 1. If there is still no improvement, change the setting to High 2. For more information, refer to <i>Service Setting (for Maintenance) on page 4-128</i>.</p>



Error Messages

The following table lists errors and maintenance messages that you can be dealt with by yourself. If `Machine failure. Call service.` appears, turn off the printer, disconnect the power cord, and contact your service technician.

If `Machine failure. Call service.` or `Error occurred.` Turn the main power switch off and on. `is` displayed, turn off the printer then turn it back on to see if the printer has recovered. If the printer has not recovered, turn off the printer, disconnect the power cord, and contact your service representative or authorized service center.

Some errors cause the alarm to sound. To stop the alarm, press **[Cancel]**.

Message	Corrective Action
<pre>A machine administrator right is required.</pre>	<p>You can only change the settings selected when logged in as a user with machine administrator privileges.</p>
<pre>Access denied. You cannot login.</pre>	<p>The Log in operation failed for the specified number of times so it is no longer possible to attempt to log in. Contact a system administrator.</p>
<pre>Access point was not detected.</pre>	<p>It was not possible to connect to the network with the optional wireless network interface kit. Check the settings of the wireless network interface. For details, refer to <i>Optional Network (Optional Network settings)</i> on page 4-62.</p>
<pre>Account error. Press [OK].</pre>	<p>This message is displayed when the Job Accounting function is enabled and an attempt to specify job accounting settings or to register or delete an account fails. To return the printer to the print-ready status, press [OK].</p>

Message	Corrective Action
<p>Add paper in casset.#</p>	<p>The paper has run out in the paper source displayed. Supply paper according to the paper source displayed (paper cassettes, MP tray, or optional paper feeders).</p>
<p>Add paper in MP tray.</p>	<p>The paper has run out in the paper source displayed. Supply paper according to the paper source displayed (paper cassettes, MP tray, or optional paper feeders).</p>
<p>Administrator only.</p>	<p>You can only change the settings selected when logged in as a user with administrator privileges.</p>
<p>Alternative:  A5 Bond  A5 Plain  A4 Preprint</p>	<p>When the cassette does not contain any paper that matches the print data (paper size and type), this message allows you to specify an alternative cassette to use instead. A paper source number is only displayed when an optional paper feeder is installed. To print from a different paper source, refer to <i>Paper Feed Mode (Setting the paper feed source)</i> on page 4-40.</p>
<p>Box limit exceeded.</p>	<p>The box capacity is full. Either delete files or change the capacity of the box. For details, refer to <i>Custom Box operation (Box creation, editing and deletion)</i> on page 5-5.</p>
<p>Canceling...</p>	<p>Displayed when data is being canceled.</p>
<p>Cannot connect.</p>	<p>It was not possible to connect to the network with the optional wireless network interface kit. Check the settings of the wireless network interface. For details, refer to <i>Optional Network (Optional Network settings)</i> on page 4-62.</p>

Message	Corrective Action
<p>Cannot connect to Authentication Server Check the domain name.</p>	<p>Press [OK] and check the following items:</p> <ul style="list-style-type: none"> • Registration to Authentication Server • Password and computer address for Authentication Server • Connection of Network <p>For details, refer to <i>Netwk Auth. Set (Netwk authentication setting)</i> on page 4-111.</p>
<p>Cannot connect. Multiple access points are enabled.</p>	<p>Multiple access points were detected with the optional wireless network interface kit. Check the settings of the wireless network interface. For details, refer to <i>Optional Network (Optional Network settings)</i> on page 4-62.</p>
<p>Cannot duplex print on this paper.</p>	<p>You attempted to print with a paper size and paper type that cannot be used for duplex printing. Press [OK] to print onto one-side of the paper only.</p>
<p>Cannot execute this job. Restricted by Authorization settings.</p>	<p>This message is shown when operations are restricted in the account when job accounting is effective. To change the account settings, refer to <i>Detail/Edit (Checking/editing registered account ID settings)</i> on page 4-124.</p>
<p>Cannot perform.</p>	<p>It is not possible to perform sanitization because a job is being processed, etc.</p>
<p>Cannot remove the memory while in use.</p>	<p>This message is displayed when <i>Remove Memory</i> was selected while a USB memory was being used. The previous screen is displayed again 1 or 2 seconds.</p>
<p>Cassette# not loaded.</p>	<p>The corresponding paper cassette is not installed. Install the cassette. The cassette number can be 1 (topmost) to 5 (bottom).</p>

Message	Corrective Action
<p>Check cassette #.</p>	<p>This message is displayed when a paper lift error has occurred in the paper source's cassette. Pull out the cassette for the paper source displayed (either the paper cassettes or optional paper feeders) and check if the paper is loaded correctly. The message <code>Call service.</code> is displayed when this error occurs repeatedly.</p>
<p>Check waste toner box.</p>	<p>This message warns following two cases. Install the new waste toner box. The waste toner box is not installed. The waste toner box is full. For details, refer to <i>Replacing the Waste Toner Box on page 7-6</i>.</p>
<p>Close left cover.</p>	<p>The left cover of the printer is open. Close the left cover.</p>
<p>Close rear cover.</p>	<p>The rear cover of the printer is open. Close the rear cover.</p>
<p>Close top cover.</p>	<p>The top cover of the printer is open. Close the printer top cover.</p>
<p>Developer unit is not installed.</p>	<p>The developer unit is either not installed or incorrectly inserted. Insert the developer unit securely. Contact your Service Representative.</p>
<p>Drum unit is not installed.</p>	<p>The drum unit is either not installed or incorrectly inserted. Insert the drum unit securely. Contact your Service Representative.</p>

Message	Corrective Action
<p>Enclose the IPv6 address in brackets [].</p>	<p>The IPv6 address entered in the host name is not enclosed in brackets []. To enter the IPv6 address, enclose the address in brackets []. (e.g., [3ae3:9a0:cd05:b1d2:28a:1fc0:a1:10ae]:140)</p>
<p>Envelope mode.</p>	<p>Displayed when the envelope switches are set to envelope mode.</p>
<p>Error occurred. Turn the main power switch off and on. #####</p>	<p>Press the power switch to turn off, and then press it again to turn on. If this message still remains, press the power switch to turn off, and contact your service representative.</p>
<p>Failed to get the network user information.</p>	<p>An error occurred when obtaining user information after the authentication. Log in again.</p>
<p>File was deleted. Check the document box.</p>	<p>The file or box selected does not exist. Check that the box has not been deleted, or that the file has not been deleted or moved.</p>
<p>Format SD card.</p>	<p>The SD/SDHC Memory Card inserted in the printer is not formatted, and therefore cannot be read or written. To format an SD/SDHC Memory Card, follow the procedure in <i>Format SD Card (Formatting the SD/SDHC memory card)</i> on page 4-83.</p>

Message	Corrective Action
<p>Format SSD.</p>	<p>The SSD (HD-6) inserted in the printer is not formatted, and therefore cannot be read or written. To format an SSD, follow the procedure in <i>Format SSD (Formatting the SSD)</i> on page 4-82.</p>
<p>Fuser unit is not installed.</p>	<p>The fuser unit is either not installed or incorrectly inserted. Insert the fuser unit securely. Contact your Service Representative.</p>
<p>Incorrect account ID.</p>	<p>The Account ID does not match. Check the registered Account ID. For more information, refer to <i>Job Account.Set. (Job Account setting)</i> on page 4-120.</p>
<p>Incorrect account ID. Press [OK].</p>	<p>This message is displayed when the Job Accounting function is enabled and no account is set for a transmitted print job or the specified account is not registered (the incorrect account is set). To return the printer to the print-ready status, press [OK]. For more information, refer to <i>Job Account.Set. (Job Account setting)</i> on page 4-120.</p>
<p>Incorrect ID.</p>	<p>The user ID entered for a private job is not correct. Check the user ID that you specified on the printer driver.</p>
<p>Incorrect login user name or password.</p>	<p>The NTLM server rejected the authentication. Enter the correct Login User Name or Password.</p>

Message	Corrective Action
<p>Incorrect login user name or password. Job is canceled.</p>	<p>Enter the correct Login User Name or Login Password.</p>
<p>Incorrect password.</p>	<p>Enter the correct password.</p>
<p>Job Accounting restriction exceeded. Press [OK].</p>	<p>This message is displayed when the Job Accounting function is enabled and an attempt has been made to exceed the print limit set for each account. To return the printer to the print-ready status, press [OK]. For more information, refer to <i>Job Account.Set. (Job Account setting) on page 4-120</i>.</p>
<p>Job not stored. Press [OK].</p>	<p>Printing using the Custom Box and Job Box function failed because there was insufficient space available on the SSD, RAM disk or SD/SDHC Memory Card, or because the RAM disk was disabled when demounting the SSD. To print an error report and return the printer to the print-ready status, press [OK].</p>
<p>KPDL error. Press [OK].</p>	<p>Current print processing cannot continue because of occurrence of KPDL error. To print out an error report, display <i>KPDL Error Rpt.</i> from the menu system, and select <i>On</i>. Press [OK] to resume printing. You can abandon printing by pressing [Cancel]. If Auto Error Clear is set to <i>On</i>, printing will be automatically resumed after a preset period of time.</p>
<p>Limit exceeded. You cannot add any more.</p>	<p>The added box exceeded the maximum number of box. Delete it if there is a unnecessary box. For details, refer to <i>Custom Box operation (Box creation, editing and deletion) on page 5-5</i>.</p>

Message	Corrective Action
<div data-bbox="108 304 512 517" style="border: 1px solid black; padding: 5px;"> Load paper in cassette #. A4 </div> <div data-bbox="264 546 357 591" style="text-align: center; margin: 10px 0;">  </div> <div data-bbox="108 613 512 831" style="border: 1px solid black; padding: 5px;"> Different paper size is set. Check paper size. </div>	<p>The size of the paper in the cassette and the paper size on the paper size dial are not the same. Check the paper size.</p>
<div data-bbox="108 875 512 1088" style="border: 1px solid black; padding: 5px;"> Load paper in cassette #. A4 Plain </div>	<p>The paper cassette matching the paper size and paper type of the print job is empty. Load paper into the paper cassette as displayed in place of #. Press [OK] to resume printing. If you want to print from a different paper source, press [Alt] ([Left Select]) to display <i>Alternative:</i> and you can change the source for paper feeding. You can abandon printing by pressing [Cancel].</p>
<div data-bbox="108 1128 512 1341" style="border: 1px solid black; padding: 5px;"> Load paper in MP tray. A4 Plain </div>	<p>There is no paper cassette installed in the printer that matches the paper size and paper type of the print job. Set paper in the MP tray. Press [OK] to resume printing. (Note that feeding the paper having a paper size which does not match the current paper size from the MP tray can cause paper jam.) If you want to print from a different paper source, press [Alt] ([Left Select]) to display <i>Alternative:</i> and you can change the source for paper feeding. You can abandon printing by pressing [Cancel].</p>
<div data-bbox="108 1382 512 1594" style="border: 1px solid black; padding: 5px;"> Loading paper. </div>	<p>The selected cassette is being prepared.</p>
<div data-bbox="108 1635 512 1848" style="border: 1px solid black; padding: 5px;"> Low security </div>	<p>This message is displayed when Low was selected in Security Level.</p>

Message	Corrective Action
<p>Machine failure. Call service.</p> <p style="text-align: right;">####:0123456</p>	<p>#### represents a mechanical error (#=0, 1, 2, ...). Call for service. The printer does not operate when this message is displayed. The total number of pages printed is also indicated, e.g. 0123456.</p>
<p>Match the paper type And the envelope switch position.</p>	<p>Displayed when the paper type does not match the envelope switch setting.</p>
<p>Memory is full. Print job cannot be processed completely.</p>	<p>The total amount of data received by the printer exceeds the printer's internal memory. Try adding more memory. Press [OK] to resume printing. You can abandon printing by pressing [Cancel]. If Auto Error Clear is set to On, printing will be automatically resumed after a preset period of time.</p>
<p>No multi copies. Press [OK].</p>	<p>Multi copies cannot be printed because RAM disk is disabled or the SSD is not installed. Try adding more memory or installing SSD, and configuring the RAM disk settings.</p>
<p>Non-genuine Toner. Press [Help].</p>	<p>This message is displayed if the installed toner container is non-genuine. The manufacturer assumes no responsibility for damage caused by a non-genuine toner. We recommend that you only use genuine toner containers. When you want to use the toner container currently installed, press [OK] and [Cancel] simultaneously for 3 seconds or more.</p>
<div style="display: flex; align-items: center;">  <div> <p>Paper jammed #####</p> <p>[Help]</p> </div> </div>	<p>A paper jam has occurred. The location of the paper jam is indicated in place of the #'s. For details, refer to <i>Clearing Paper Jams on page 8-17</i></p>
<p>Paper path error. Set cassette #.</p>	<p>There is no paper cassette in the feeder, or the cassette is not inserted properly. After reinserting the corresponding paper cassette, you should be able to print. When two or more optional feeders are installed and the lowest one is selected, the same message will appear if any of the upper paper feeder and the printer cassette is improperly installed.</p>

Message	Corrective Action
<p>Print overrun.</p>	<p>The data transferred to the printer was too complex to print on a page. Press [OK] to resume printing.</p>
<p>RAM disk error. Press [OK].</p> <p style="text-align: right;">##</p>	<p>A RAM disk error has occurred. Look at the error code given in place of ##. The possible error codes and their descriptions are as follows.</p> <p>02: RAM Disk Mode is set to <i>Off</i>. Set the setting to <i>On</i>. Refer to <i>RAM Disk Mode (Setting the RAM disk) on page 4-82</i>.</p> <p>03: The RAM disk is write protected using command operation. Remove the write protection using the command.</p> <p>04: No disk space. Purge unnecessary files or increase the RAM disk size. For more information, refer to <i>RAM Disk Size (RAM disk size setting) on page 4-82</i>.</p> <p>05: The desired file does not exist in the RAM disk. Stored the file in the RAM disk.</p> <p>10: The file stored in the RAM disk is write protected using command operation. Remove the write protection using the command.</p>
<p>Registered numbers exceeded. Cannot add.</p>	<p>There are already 100 accounts registered so it is not possible to register any new accounts.</p>
<p>Replace MK.</p>	<p>Replace Maintenance Kit which is displayed on the message display. Replacement of the maintenance kit is necessary at every 500,000 images of printing (or every 300,000 images on FS-2100D/FS-2100DN) and requires professional servicing.</p>
<p>Replace the toner.</p>	<p>Toner has run out in the toner container. Replace the toner container using a new toner kit. The printer does not operate when this message is displayed.</p>
<p>Restricted by Job Accounting. Press [OK].</p>	<p>This message is displayed when printing was attempted, despite the Job Account function being on with Restriction applied as the job limit for each job account.</p> <p>To return the printer to the print-ready status, press [OK].</p> <p>For more information, refer to <i>Job Account.Set. (Job Account setting) on page 4-120</i>.</p>

Message	Corrective Action
<div style="border: 1px solid black; padding: 5px;"> <p>SD card error. Press [OK].</p> <p style="text-align: right;">##</p> </div>	<p>An SD/SDHC Memory Card error has occurred. Look at the error code given in place of ##.</p> <p>The possible error codes and their descriptions are as follows.</p> <p>02: The printer does not support the SD/SDHC memory card inserted, or the SD/SDHC memory card is broken. Install the correct SD/SDHC memory card.</p> <p>03: The SD/SDHC memory card is write protected using command operation. Remove the write protection using the command.</p> <p>04: There is not enough space in the SD/SDHC memory card. Delete unnecessary files or use a new SD/SDHC memory card.</p> <p>05: The desired file does not exist in the SD/SDHC memory card. Stored the file in the SD/SDHC memory card.</p> <p>10: The file stored in the SD/SDHC memory card is write protected using command operation. Remove the write protection using the command.</p>
<div style="border: 1px solid black; padding: 5px;"> <p>SSD error. Press [OK].</p> <p style="text-align: right;">##</p> </div>	<p>An SSD error has occurred. Look at the error code given in place of ##.</p> <p>The possible error codes and their descriptions are as follows.</p> <p>03: The SSD is write protected using command operation. Remove the write protection using the command.</p> <p>04: There is no available SSD space. Delete unnecessary files, etc., in order to free up space.</p> <p>05: The desired file does not exist in the SSD. Stored the file in the SSD.</p> <p>10: The file stored in the SSD is write protected using command operation. Remove the write protection using the command.</p>
<div style="border: 1px solid black; padding: 5px;"> <p>The file name already exists. You cannot copy.</p> </div>	<p>Copying is not possible because data with the same file name exists at the destination. Delete the data with the same file name at the destination before copying.</p>
<div style="border: 1px solid black; padding: 5px;"> <p>The user name is not registered.</p> </div>	<p>The login user name entered is not registered. Check the login user name.</p>
<div style="border: 1px solid black; padding: 5px;"> <p>This account ID is already registered.</p> </div>	<p>The account ID set has already been registered. Register a different account ID.</p>
<div style="border: 1px solid black; padding: 5px;"> <p>This login user name already registered.</p> </div>	<p>The changed login user name has already been registered. Set a different login user name.</p>

Message	Corrective Action
<p>Toner is running out.</p>	<p>The toner has run low. Ensure that a new toner container is available without delay. For details, refer to <i>Toner Container Replacement on page 7-2</i>.</p>
<p>Top tray is full of paper. Remove the paper.</p>	<p>The top tray has become full (approx. 250 (FS-2100D and FS-2100DN) or 500 (FS-4100DN, FS-4200DN and FS-4300DN) pages). You must remove all printed pages from the top tray. When the printer detects that the top tray is empty again, the printer will continue printing into the top tray.</p>
<p>Unknown toner installed. PC</p>	<p>This message is displayed if the installed toner container's regional specification does not match the machine's. Install the specified toner container.</p>
<p>USB memory error. Press [OK]. ##</p>	<p>An error has occurred in the USB memory device. Look at the error code given in place of ##. The possible error codes and their descriptions are as follows. 01: The amount of data that can be saved at once has been exceeded. Split the large file into multiple smaller files. The USB memory is write protected. Remove the write protection. The USB memory is broken. Even if the problem is not solved, format the USB memory with the device or use the new USB memory compatible with the printer. 04: There is no available space. Delete unnecessary files, etc., in order to free up space.</p>

Clearing Paper Jams



If paper jams in the paper transport system, or no paper sheets are fed at all, the Paper jam message appears and the location of the paper jam (the component where the paper jam has occurred) is also indicated. Status Monitor or Command Center RX can indicate the location of the paper jam (the component where the paper jam has occurred). Remove the paper jam. After removing the paper jam, the printer will resume printing.

IMPORTANT The printer may not feed the paper correctly depending on the paper type. Print several pages to confirm whether the printer can feed the paper. To feed thick paper smoothly, you can select the half speed mode from the printer driver. For more information, refer to *Half Speed Mode (Printer Driver Settings)* on page 3-6.

Possible Paper Jam Locations

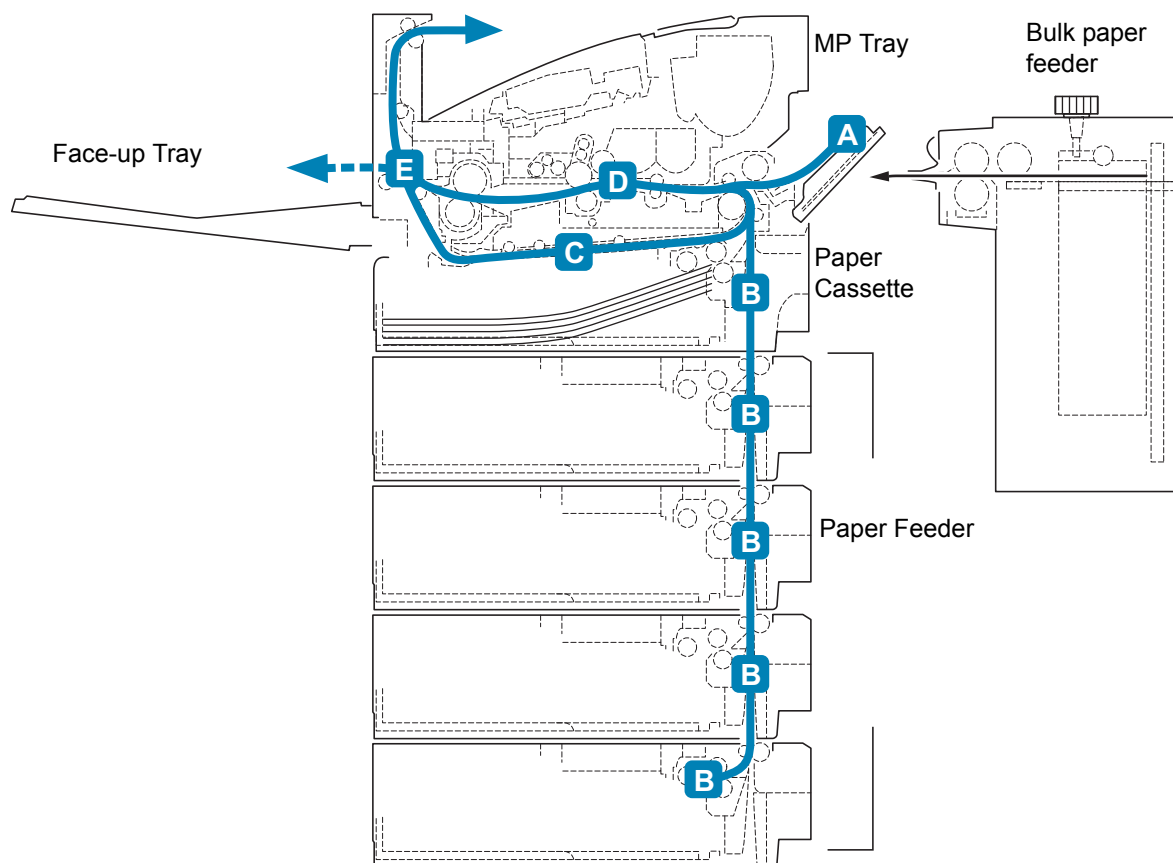
The figure below shows the printer's paper paths including the optional paper feeder. The locations where paper jams might occur are also shown here, with each location explained in the table below. Paper jams can occur in more than one component on the paper paths.

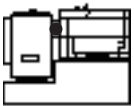
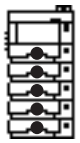

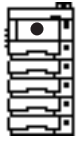
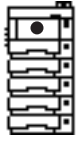
Paper Jam Message	Paper jam location	Description	Reference Page
 <p>Paper jammed at MP tray.</p> <p>[Help]</p>	<p>A</p>	<p>Paper is jammed at the MP tray or optional bulk paper feeder.</p>	<p><i>page 8-19</i> <i>page 8-23</i></p>
 <p>Paper jammed in the Bulk Feeder.</p> <p>[Help]</p>			
 <p>Paper jammed in cassette #.</p> <p>[Help]</p>	<p>B</p>	<p>Paper is jammed at the paper cassette. The cassette number can be 1 (topmost) to 5 (bottom).</p>	<p><i>page 8-20</i></p>
 <p>Paper jammed in the duplex unit.</p> <p>[Help]</p>	<p>C</p>	<p>Paper is jammed inside the duplex section.</p>	<p><i>page 8-21</i></p>
 <p>Paper jammed in the printer.</p> <p>[Help]</p>	<p>D</p>	<p>Paper is jammed inside the printer.</p>	<p><i>page 8-22</i></p>
 <p>Paper jammed in the Rear cover.</p> <p>[Help]</p>	<p>E</p>	<p>Paper is jammed inside the rear unit.</p>	<p><i>page 8-23</i></p>

General Considerations for Clearing Jams

Bear in mind the following considerations when attempting paper jam removal:



CAUTION When pulling the paper, pull it gently so as not to tear it. Torn pieces of paper are difficult to remove and may be easily overlooked, deterring the paper jam recovery.

- If paper jams occur frequently, try using a different type of paper, replace the paper with paper from another ream, or flip the paper stack over. The printer may have problems if paper jams recur after the paper is replaced.
- Whether or not the jammed pages are reproduced normally after printing is resumed, depends on the location of the paper jam.

Utilizing Online Help Messages

When Paper Jam is displayed, press [Help] (**[Left Select]**) to display the procedure to clear the jam.

Press ▾ to display the next step or press ▴ to display the previous step.

Press **[OK]** to exit the online help message display.

MP Tray

Paper is jammed at the MP tray. Remove the jammed paper using the procedure given below.

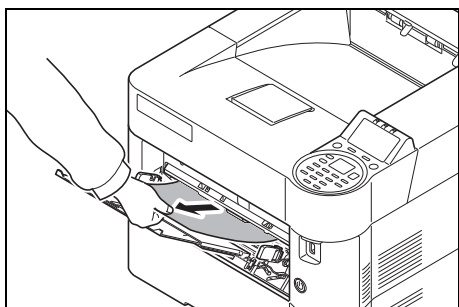

- 1** Remove the paper jammed at the MP tray.

IMPORTANT Before clearing the jammed paper, remove the paper on the MP tray.

- 2** Open and close the top cover to clear the error.

Paper Cassette/Paper Feeder

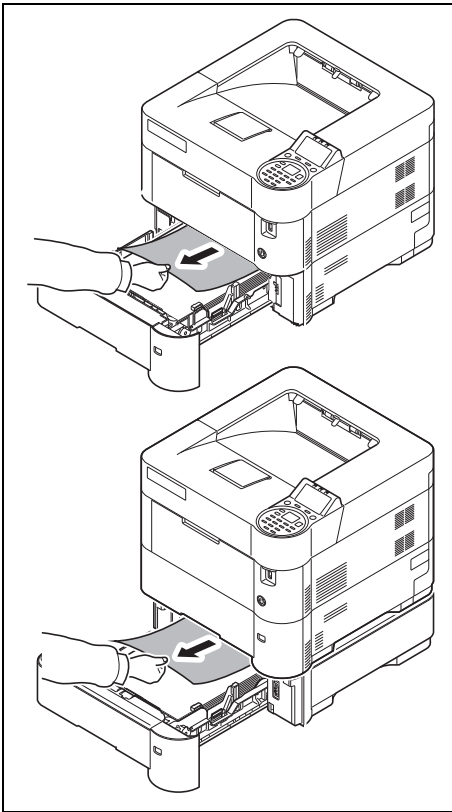

- 1** Pull out the cassette or optional paper feeder.
- 2** Remove any partially fed paper.



Note Check to see if paper is loaded correctly. If not, reload the paper.

- 3** Push the cassette back in securely. The printer warms up and resumes printing.

Duplex Unit

Paper is jammed in the duplex section. Remove the jammed paper using the procedure given below.

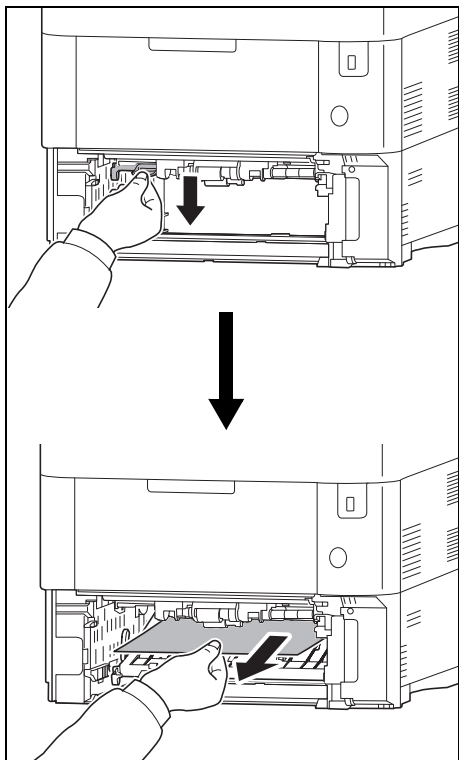

- 1** Pull the cassette all the way out of the printer.
- 2** Open the duplex front cover and remove any jammed paper.

- 3** Close the duplex front cover.
- 4** Insert the cassette into the slot in the printer. The printer warms up and resumes printing.

Inside the Printer

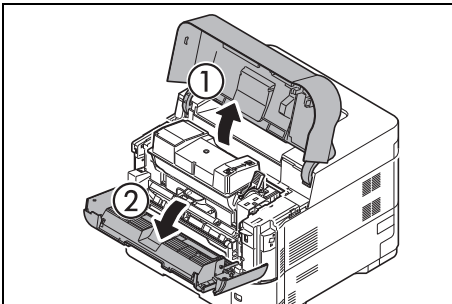

- 1 Open the top cover and front cover.

IMPORTANT Before clearing the jammed paper, remove the paper on the MP tray.

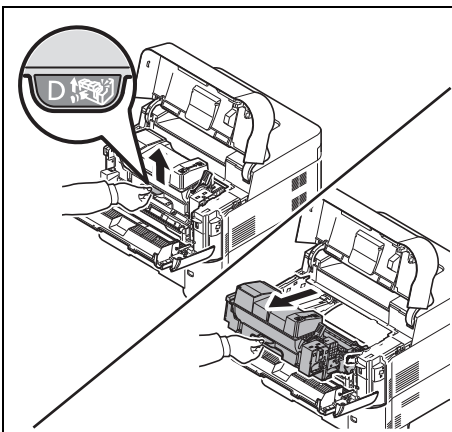

- 2 Pull the developer unit together with the toner container.

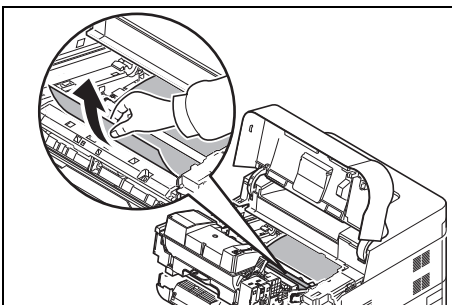

- 3 Remove the paper from the printer

If the jammed paper appears to be pinched by rollers, pull it along the normal running direction of the paper.



Note If you cannot find a paper jam, try checking inside the rear of the printer. Refer to *Rear Unit* on page 8-23.

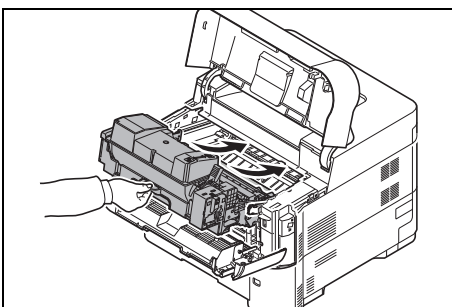

- 4 Insert the developer unit together with the toner container, back into the machine.

- 5 Close the front cover and top cover. The printer warms up and resumes printing.

Rear Unit

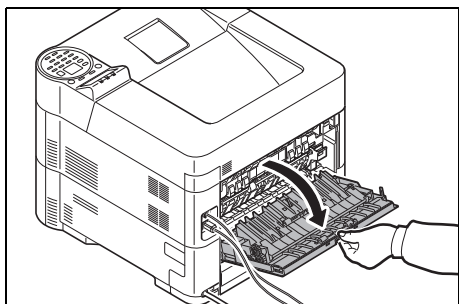

- 1 If paper is not completely ejected into the top tray, open the rear cover.

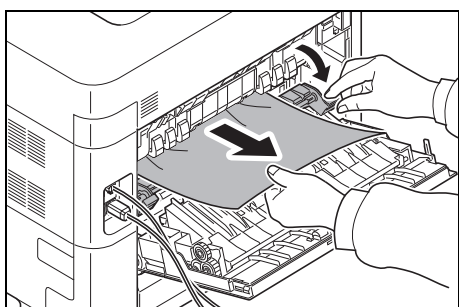

- 2 Open the fuser cover and remove the jammed paper by pulling it out.



Note If you cannot find a paper jam, try checking inside the rear of the printer.



CAUTION The fuser unit inside the printer is hot. Do not touch it with your hands as it may result in burn injury. Remove jammed paper carefully.

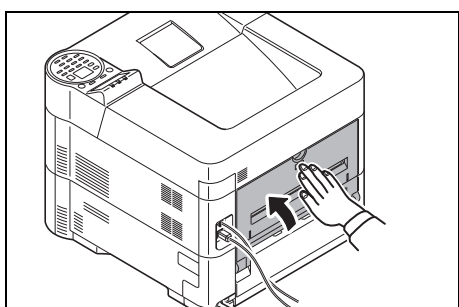

- 3 Close the rear cover. The printer warms up and resumes printing out.

Bulk Paper Feeder

Paper is jammed at the optional bulk paper feeder. Detach the bulk paper feeder from the printer by sliding with the rail away from the printer, holding the bulk paper feeder by both hands. If paper is partially fed out from the feeder's output slot, pull the paper out by hand. For details, refer to the *PF-315+ Installation Guide*.

Appendix

This chapter contains explanations on the following topics:

Character Entry Method	A-2
About the Options.....	A-5
Expansion Memory Modules	A-6
General Description of Options	A-9
Paper	A-13
Specifications.....	A-23

For availability of the options, consult your service technician.

Character Entry Method

In character entry screens, use the procedure below to enter characters.

Keys Used

Use the following keys to enter characters.

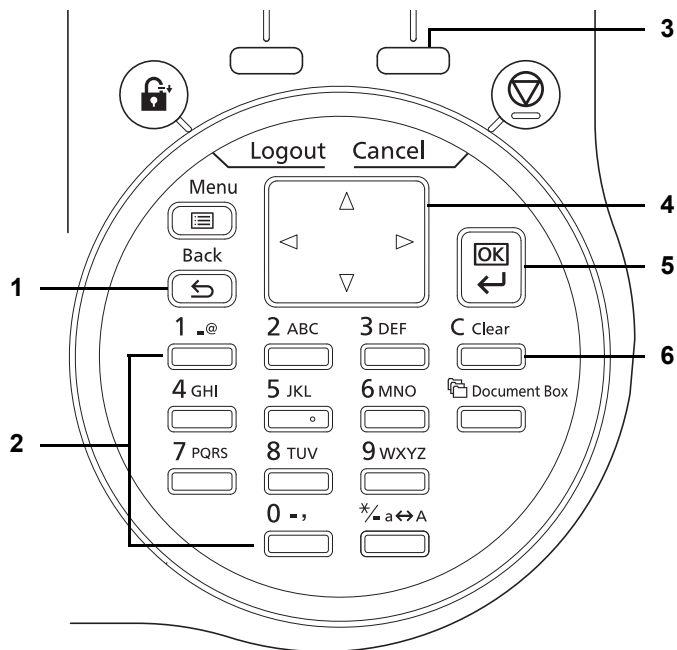

- 1 **[Back]** Key: Press this key to return to the screen from which you invoked the character entry screen.
- 2 **Numeric Keys:** Use these keys to select the character you want to enter.
- 3 **[Right Select]** Key: Press this key to select the type of characters you want to enter. (When [Text] is displayed)
- 4 **Arrow Keys:** Use these to select the entry position, or select a character from the character list.
- 5 **[OK]** Key: Press this key to finalize the entered character(s).
- 6 **[Clear]** Key: Press this key to delete the character at the cursor position. If the cursor is at the end of the line, the character to the left of it is deleted.

Selecting Type of Characters

To enter characters, the following three types are available:

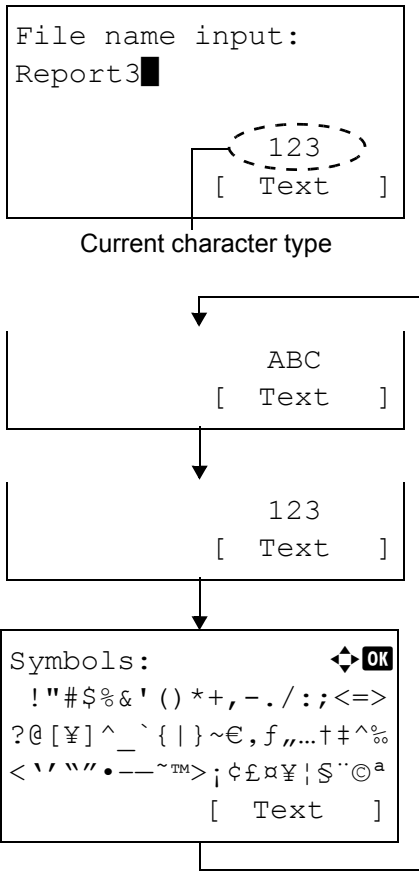

Types	Description
ABC	To enter alphabets.
123	To enter numerals.
Symbols	To enter symbols.

In a character entry screen, press [Text] (**[Right Select]**) to select the type of characters you want to enter.

Each time you press [Text] (**[Right Select]**), the character type switches as follows: ABC, 123, Symbols, ABC ...







Entering Characters

After selecting a character type, use the procedure below to enter characters.

Entering Alphabets and Numerals

Referring to the table below, press the key corresponding to the character you want to enter until it is displayed.

Key	Entry mode	Available characters
1 <input type="text"/> _.@	Alphabetic/Symbol	. @ - _ / : ~ 1
	Numeric	1
2 <input type="text"/> ABC	Alphabetic/Symbol	a b c A B C 2
	Numeric	2
3 <input type="text"/> DEF	Alphabetic/Symbol	d e f D E F 3
	Numeric	3
4 <input type="text"/> GHI	Alphabetic/Symbol	g h i G H I 4
	Numeric	4

Key	Entry mode	Available characters
5 JKL 	Alphabetic/Symbol	j k l J K L 5
	Numeric	5
6 MNO 	Alphabetic/Symbol	m n o M N O 6
	Numeric	6
7 PQRS 	Alphabetic/Symbol	p q r s P Q R S 7
	Numeric	7
8 TUV 	Alphabetic/Symbol	t u v T U V 8
	Numeric	8
9 WXYZ 	Alphabetic/Symbol	w x y z W X Y Z 9
	Numeric	9
0 -, 	Alphabetic/Symbol	., - _ ' ! ? (space) 0
	Numeric	0
*/_ a ↔ A 	Alphabetic/Symbol	Switch between upper-/lowercase
	Numeric	. (period)

Characters associated with different keys can be entered consecutively. To enter a character associated with the same key after another, use cursor keys to move the cursor to the next entry position before entering it.

If you use cursor keys to move the cursor to an entry position apart from the end of the line and enter a character there, spaces are automatically entered in between.

Entering Symbols

Press [Text] ([Right Select]) to display the Symbols screen. Use cursor keys to select the symbol you want to enter and then press [OK].

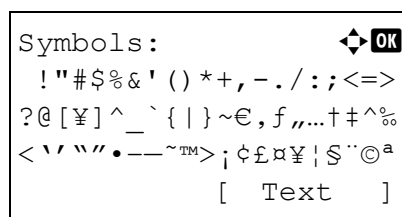

About the Options

This printer has the following options available to satisfy your printing requirements. For instructions on installing individual options, refer to the documentation included with the option. Some options are explained in the following sections.

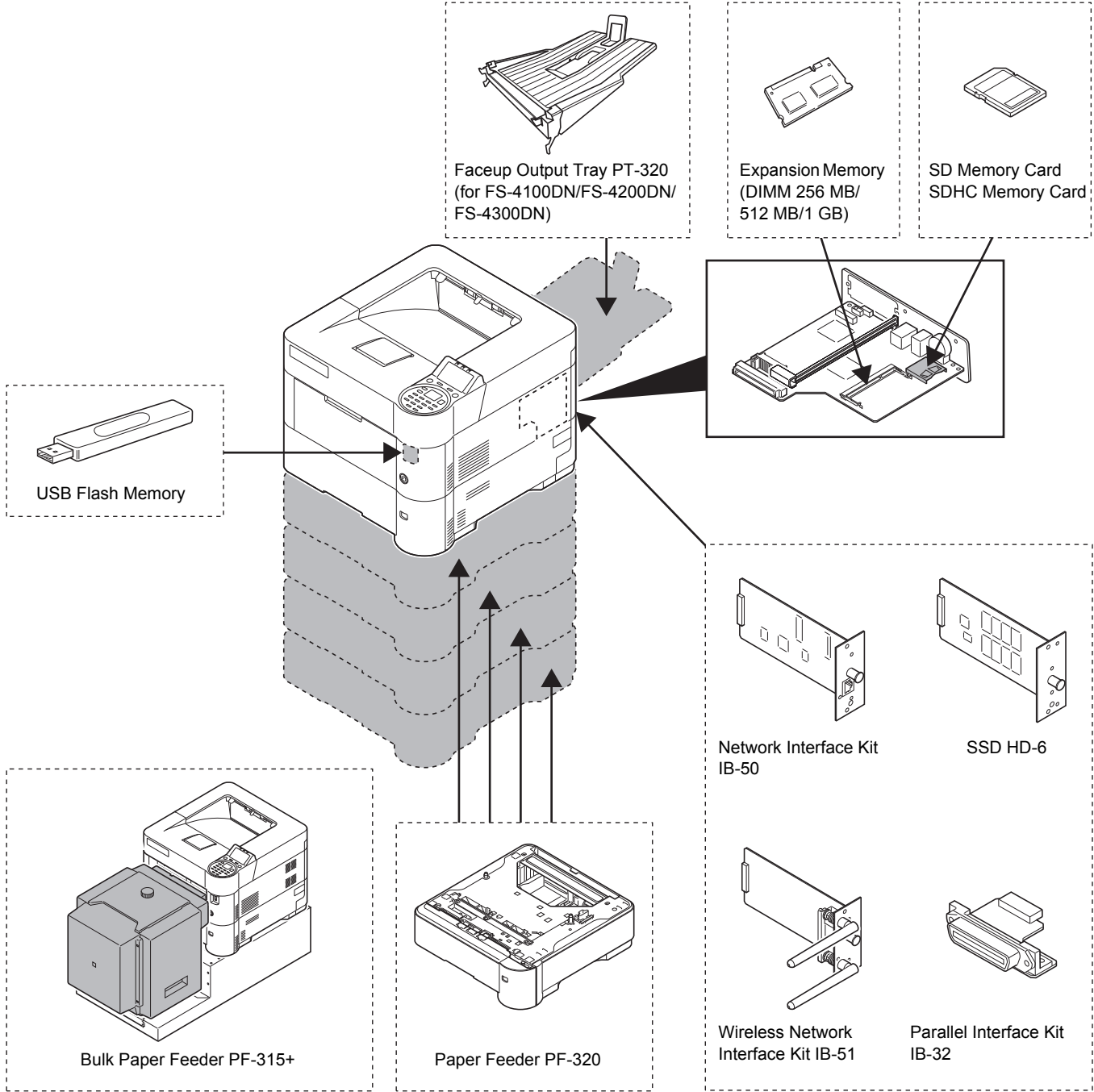

Expansion Memory Modules

The printer's main controller board has a memory slot into which you can plug in optional memory modules (dual in line memory modules). You can increase the printer's memory up to 1280 MB (or 1152 MB on FS-2100D) by plugging in the optional memory modules.

 **Note** A 256 MB (or 128 MB on FS-2100D) memory module is already installed at the factory. To expand memory up to 1280 MB (or 1152 MB on FS-2100D), install 1024 MB memory module.

Expansion Memory Modules

You can select additional memory modules from 256, 512 or 1024 MB.

Precautions for Handling the Printer's Main Controller Board and Memory Modules

To protect electronic parts, discharge static electricity from your body by touching a water pipe (faucet) or other large metal object before handling the memory modules. Or, wear an antistatic wrist strap, if possible, when you install the memory modules.

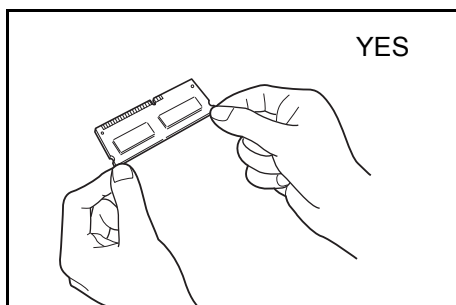

Always hold the main controller board or a memory module by its edges as shown below to avoid damaging electronic parts.

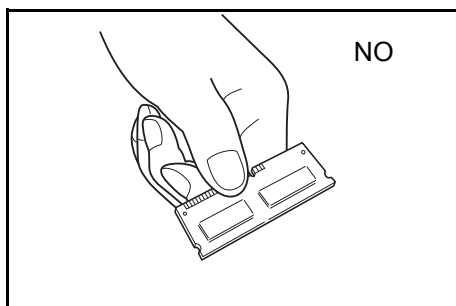

Installing the Memory Modules

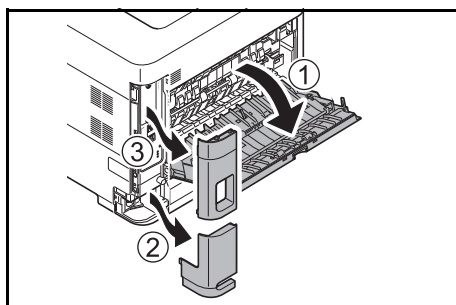

- 1** Power off the printer and unplug the printer power cord.
- 2** Open the rear cover and remove the interface cover and power cord connector cover.

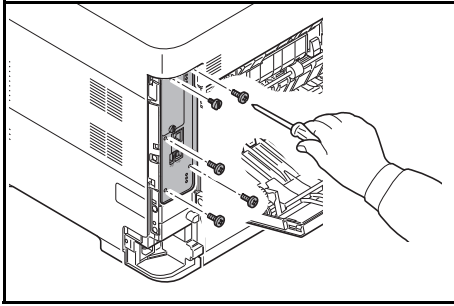

3 Unscrew five screws at the back of the main controller board.

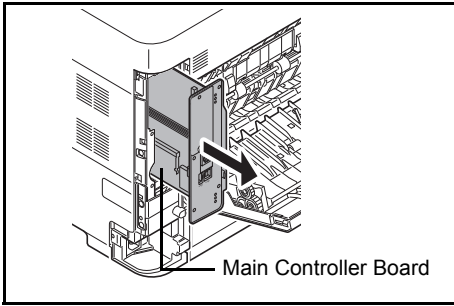

4 Pull out the main controller board gently.

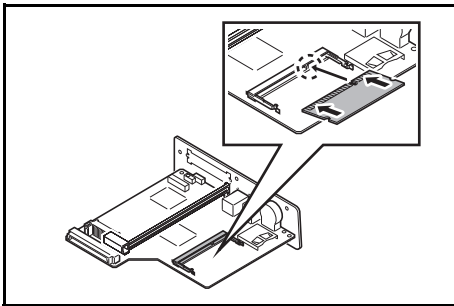

5 Remove the memory module from its package. Aligning the cutouts of the memory module with the matching keys of the socket, carefully plug the memory module into the memory socket until it clicks in place.



CAUTION Do not plug the memory module backwards.

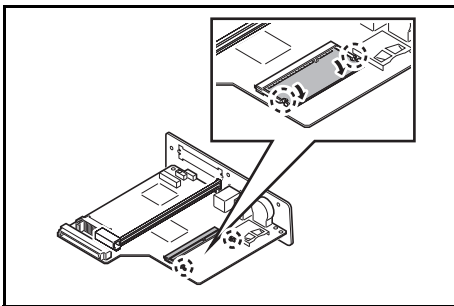

6 Push down the memory module to secure.

7 After you finish installing the memory modules, reinstall the main controller board and fasten it with screws.

Removing a Memory Module

To remove a memory module, remove the main controller board, then carefully push out the two socket clamps. Ease the memory module out of the socket to remove.

Checking Expansion Memory

After installing expansion memory, use the following method to check that it is correctly installed.

```
Print.  
Are you sure?  
→Status Page  
  
[ Yes ] [ No ]
```

- 1** In the Report Print menu, press \triangle or ∇ to select `Status Page`.
- 2** Press **[OK]**. A confirmation message is displayed.
- 3** Press `[Yes]` (**[Left Select]**). `Accepted.` appears and the printer prints the status page.

Check the amount of memory with the printed status page. If the memory addition has been done correctly, the total amount of memory will have increased. (The amount of memory when shipped from the factory is 256 MB (or 128 MB on FS-2100D).)

General Description of Options

SD/SDHC Memory Card

The printer is equipped with a slot for an SDHC memory card with a maximum size of 32 GB, and an SD memory card with a maximum size of 2 GB. An SD/SDHC memory card is useful for storing fonts, macros, and overlays.

This enables high-speed printing of multiple copies using an electric sort function. Also, you can use the Job Box functions. For details, refer to *Job Box on page 5-24*.

Reading the SD/SDHC Memory Card

Once inserted in the printer's slot, the contents of the SD/SDHC memory card can be read from the operation panel or automatically when you power on or reset the printer.

Installing and Formatting the SD/SDHC Memory Card

To use an unused SD/SDHC memory card, you must first use the printer to format the SD/SDHC memory card.

- 1 Switch off the printer, remove the power cord and then remove the main controller unit. To read how to remove the main controller unit, refer to the section on inserting the memory module.
- 2 Insert the SD/SDHC memory card into the SD/SDHC memory card slot.

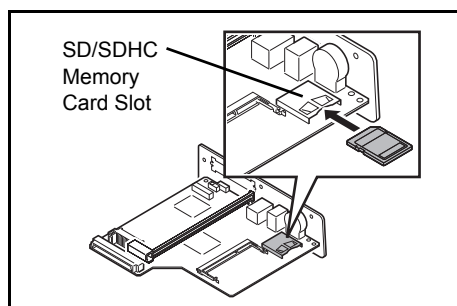

- 3 Attach the main controller unit to the printer in the reverse procedure to when it was removed.
- 4 Format the SD/SDHC memory card from the operation panel. For the procedure for formatting, refer to *Format SD Card (Formatting the SD/SDHC memory card) on page 4-83*.

PF-320 Paper Feeder

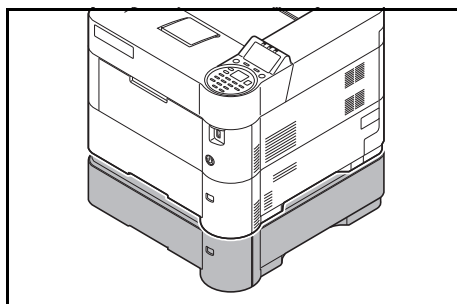

The optional paper feeder PF-320 will each hold approximately 500 sheets of paper. Up to 4 optional feeders can be added to the bottom of the printer, allowing continuous feeding of up to 2,500 sheets of paper when combined with the printer's own cassette.

IMPORTANT When you use the paper feeder, place the papers print-side down.

The papers that can be used in the cassettes supplied with the paper feeders are as follows:

Paper size : Envelope Monarch, Envelope #10, Envelope #9, Envelope #6, Envelope DL, Envelope C5, A5, B5, B6, ISO B5, A4, Executive, Letter, Legal, OufukuHagaki, Oficio II, Statement, Folio, Youkei 2, Youkei 4, 216 × 340 mm, 16K and Other (92 × 162 mm to 216 × 356 mm)

Paper type : Plain, Preprinted, Bond, Recycled, Rough, Letterhead, Color, Prepunched, Envelope, High Quality, CUSTOM 1 (to 8)

SSD (HD-6)

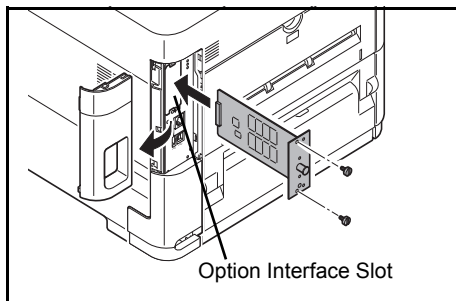

With SSD installed in the printer, received data can be rasterized and stored on this SSD. This enables high-speed printing of multiple copies using an electric sort function. Also, you can use the Document Box functions. For details, refer to *Document Box* on page 5-1.

Network Interface Kit (IB-50)

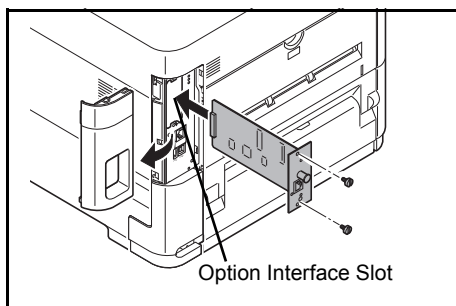

The network interface kit is a high-speed interface for communications speeds of 1 gigabit per second. In addition to the TCP/IP and NetBEUI supported by the machine's standard network interface, it also supports IPX/SPX and Apple Talk, so network printing becomes possible in various environments, including Windows, Macintosh, UNIX and Netware.

Wireless Network Interface Kit (IB-51)

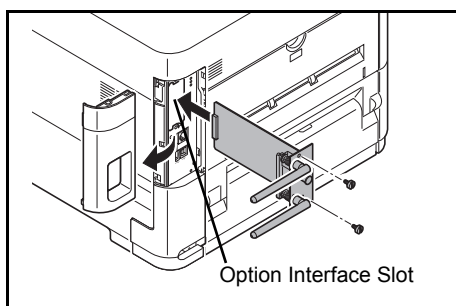

This is a wireless network interface kit which supports the wireless network specifications IEEE802.11n (Max 300 Mbps) and 11 g/b.

With the utilities supplied, settings are possible for a variety of OS and network protocols.

Parallel Interface Kit (IB-32)

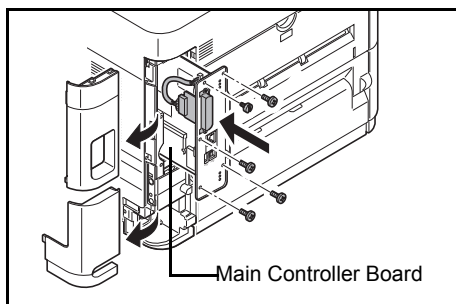

The parallel interface kit supports communications speeds up to 2 Mbps. Use a parallel printer cable when this option is used.

USB Memory

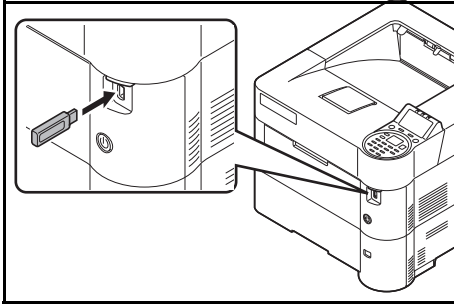

USB memory is a type of simple, highly portable flash memory that plugs into the USB memory slot. Files stored in USB memory can be printed by plugging the USB memory into the printer and then specifying the desired file names from the operation panel.

The operation panel displays the names of PDF, TIFF, JPEG and XPS files.

Up to 1,000 files can be printed from USB memory. Files with names consisting of up to 255 single-byte alphanumeric characters can be printed.

Any double-byte characters included in a file name appear as corrupted text in the message list. Also, when the file is printed an error message appears and printing fails.

For information on printing PDF files stored in USB memory, refer to *USB Memory (USB memory selection)* on page 4-17.

For information on supported USB memory devices, contact your service technician.

PT-320 Faceup Output Tray (for FS-4100DN/FS-4200DN/FS-4300DN)

Use the faceup output tray when you wish paper to be stacked with the printed side facing up (reverse order).

To install the faceup output tray, perform the following procedures:

- 1 Install the paper stopper according to the size of paper to be used.

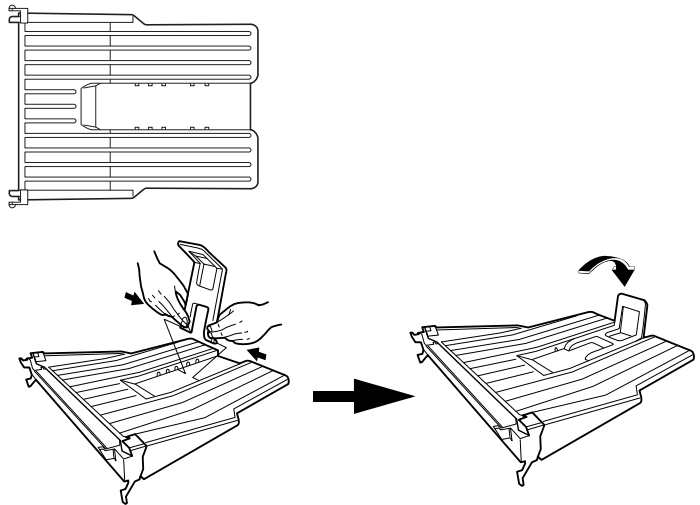

- 2 Install the faceup output tray on the rear of the printer.

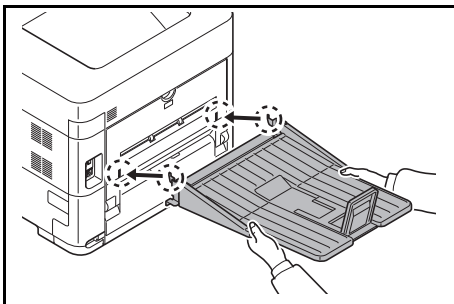

Other Options

PF-315+ Bulk Paper Feeder

Holds approximately 2,000 sheets of 76 to 216 mm × 148 to 305 mm size paper. This bulk paper feeder can be attached to the front of the printer after the MP tray has been removed.

Data Security Kit (E)

The security kit overwrites data which is no longer necessary to make it difficult to restore it. Also, when data is stored on the SSD, it encrypts the data then writes it. It is not possible to decode (read) anything other than in normal outputs and operations, so this provides greater security should it become necessary.

Card Authentication Kit (B)

It is possible to perform user authentication with an ID card. To perform authentication with an ID card, it is necessary to first register the ID card information in the list of registered users. For the method for registration, refer to the *Card Authentication Kit (B) Operation Guide*.

USB Keyboard

A USB keyboard can be used to enter information into the text fields on the operation panel. A special mount is also available to install the keyboard on the printer. Please contact your dealer or service representative for information on keyboards that are compatible with your printer before you purchase one.

ThinPrint Option

This application allows print data to be printed directly without a print driver.

Paper

General Guidelines

The machine is designed to print on standard copier paper (the type used in ordinary dry copier machines), but it can also accept a variety of other types of paper within the limits specified below.

 **Note** The manufacturer assumes no liability for problems that occur when paper not satisfying these requirements is used.

Selection of the right paper is important. Using the wrong paper can result in paper jams, curling, poor print quality, and paper waste, and in extreme cases can damage the machine. The guidelines given below will increase the productivity of your office by ensuring efficient, trouble-free printing and reducing wear and tear on the machine.

Paper Availability

Most types of paper are compatible with a variety of machines. Paper intended for xerographic copiers can also be used with the machine.

There are three general grades of paper: *economy*, *standard*, and *premium*. The most significant difference between grades is the ease with which they pass through the machine. This is affected by the *smoothness*, *size*, and *moisture content* of the paper, and the way in which the paper is cut. The higher the grade of paper you use, the less risk there will be of paper jams and other problems, and the higher the level of quality your printed output will reflect.

Differences between papers from different suppliers can also affect the machine's performance. A high-quality printer cannot produce high-quality results when the wrong paper is used. Low-priced paper is not economical in the long run if it causes printing problems.

The recommended basis weight is:

- Cassette: 60 to 120 g/m²
- MP tray: 60 to 220 g/m²
- PF-320: 60 to 120 g/m²
- PF-315+: 60 to 220 g/m²

Paper Specifications

The following table summarizes the basic paper specifications. Details are given on the following pages.

Item	Specification
Weight	Cassette, PF-320: 60 to 120 g/m ² (16 to 32 lb/ream) MP Tray, PF-315+: 60 to 220 g/m ² (16 to 59 lb/ream)
Thickness	0.086 to 0.110 mm (3.4 to 4.3 mils)
Dimensions	Refer to <i>Paper Sizes on page A-15</i>
Dimensional accuracy	±0.7 mm (±0.0276 inches)
Squareness of corners	90° ±0.2°
Moisture content	4 % to 6 %
Direction of grain	Long grain
Pulp content	80 % or more

Minimum and Maximum Paper Sizes

The minimum and maximum paper sizes are as follows. For non standard paper such as transparency, labels, vellum, cardstock, envelope and thick, the MP (Multi-Purpose) tray must be used. For information on how to set paper sizes, refer to *MP Tray Set. (MP tray settings)* on page 4-26.

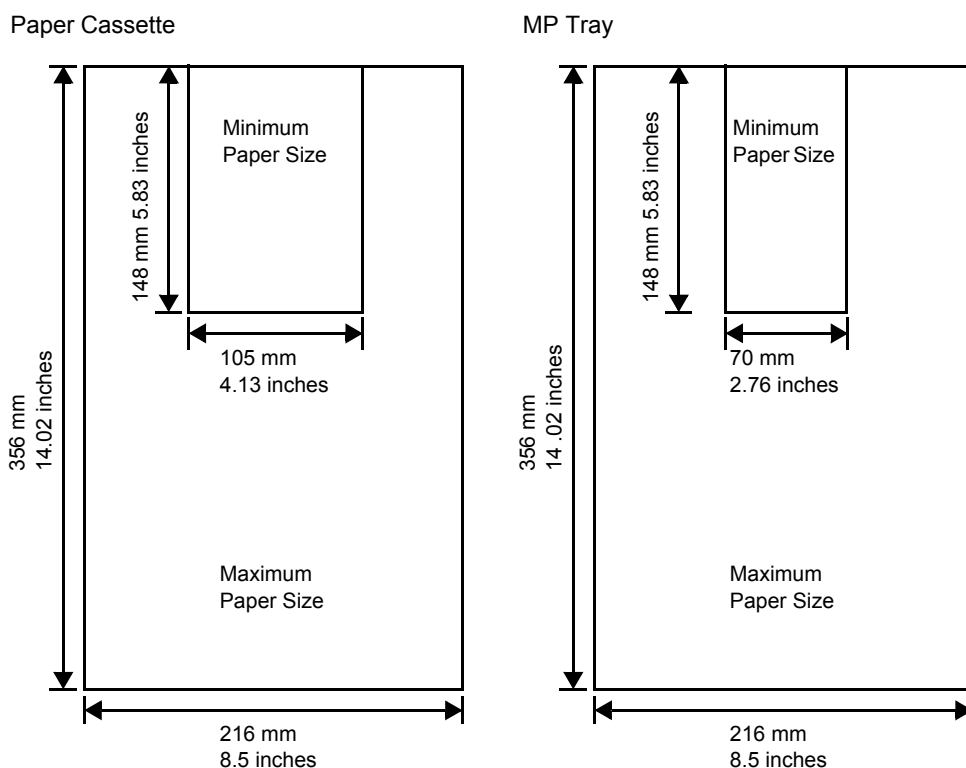

 **Note** On FS-2100D and FS-2100DN, the minimum size of Paper Cassette is 140 × 210 mm (5.5 × 8.25 inches). On the optional paper feeder (PF-320), the minimum size is 92 × 162 mm (3.62 × 6.38 inches) and the maximum size is 216 × 356 mm (8.5 × 14 inches).

Recommended Paper

The following products are recommended for use with the printer for optimum performance.

Size	Product	Weight
Letter, Legal	International Paper Hammermill Tidal MP	75 g/m ² (20 lb)
A4	Nautilus ReFresh TRIOTEC	80 g/m ²

Selecting the Right Paper

This section describes the guidelines for selecting paper.

Condition

Avoid using paper that is bent at the edges, curled, dirty, torn, embossed, or contaminated with lint, clay, or paper shreds.

Use of paper in these conditions can lead to illegible printing and paper jams, and can shorten the life of the machine. In particular, avoid using paper with a surface coating or other surface treatment. Paper should have as smooth and even a surface as possible.

Composition

Do not use paper that has been coated or surface-treated and contains plastic or carbon. The heat of fusing can cause such paper to give off harmful fumes.

Bond paper should contain at least 80 % pulp. Not more than 20 % of the total paper content should consist of cotton or other fibers.

Paper Sizes

Cassettes and the *MP tray* are available for the paper sizes listed in the table below. For details, including the paper sizes for the paper feeder (Optional paper feeder PF-320) refer to *Setting the standard paper size on page 4-28*.

The dimensional tolerances are ± 0.7 mm (± 0.0276 inches) for the length and width. The angle at the corners must be $90^\circ \pm 0.2^\circ$.

Yes: Can be stored No: Cannot be stored

Paper Size	Size	Cassette (FS-2100D/ FS-2100DN)	Cassette (FS-4100DN/ FS-4200DN/ FS-4300DN)	Cassette (PF-320)	Bulk Paper Feeder (PF-315+)	MP Tray
Envelope Monarch	3.88 × 7.5 inches	No	No	Yes	Yes	Yes
Envelope #10	4.13 × 9.5 inches	No	No	Yes	Yes	Yes
Envelope DL	110 × 220 mm	No	Yes	Yes	Yes	Yes
Envelope C5	162 × 229 mm	Yes	Yes	Yes	Yes	Yes
Executive	7.25 × 10.5 inches	Yes	Yes	Yes	Yes	Yes
Letter	8.5 × 11 inches	Yes	Yes	Yes	Yes	Yes
Legal	8.5 × 14 inches	Yes	Yes	Yes	No	Yes
A4	210 × 297 mm	Yes	Yes	Yes	Yes	Yes
B5(JIS)	182 × 257 mm	Yes	Yes	Yes	Yes	Yes
A5	148 × 210 mm	Yes	Yes	Yes	Yes	Yes
A6	105 × 148 mm	No	Yes	No	Yes [†]	Yes
B6	128 × 182 mm	No	Yes	Yes	Yes	Yes
Envelope #9	3.88 × 8.88 inches	No	No	Yes	Yes	Yes
Envelope #6-3/4	3.63 × 6.5 inches	No	No	Yes	Yes [†]	Yes
ISO B5	176 × 250 mm	Yes	Yes	Yes	Yes	Yes
Hagaki	100 × 148 mm	No	No	No	Yes [†]	Yes
OufukuHagaki	148 × 200 mm	No	Yes	Yes	Yes	Yes
Oficio II	8.5 × 13 inches	Yes	Yes	Yes	No	Yes

Paper Size	Size	Cassette (FS-2100D/ FS-2100DN)	Cassette (FS-4100DN/ FS-4200DN/ FS-4300DN)	Cassette (PF-320)	Bulk Paper Feeder (PF-315+)	MP Tray
216 × 340 mm	216 × 340 mm	Yes	Yes	Yes	No	Yes
16 kai	197 × 273 mm	Yes	Yes	Yes	Yes	Yes
Statement	5.5 × 8.5 inches	Yes	Yes	Yes	Yes	Yes
Folio	210 × 330 mm	Yes	Yes	Yes	No	Yes
Youkei 4	105 × 235 mm	No	No	Yes	Yes	Yes
Youkei 2	114 × 162 mm	No	No	Yes	Yes [†]	Yes
Custom		Cassette (FS-2100D/FS-2100DN): 140 to 216 mm × 210 to 356 mm (5.5 to 8.5 inches × 8.25 to 14.02 inches) Cassette (FS-4100DN/FS-4200DN/FS-4300DN): 105 to 216 mm × 148 to 356 mm (4.13 to 8.5 inches × 5.83 to 14.02 inches) Cassette (PF-320): 92 to 216 mm × 162 to 356 mm (3.62 to 8.5 inches × 6.38 to 14.02 inches) MP Tray: 70 to 216 mm × 148 to 356 mm (2.76 to 8.5 inches × 5.83 to 14.02 inches) Bulk Paper Feeder (PF-315+): 76 to 216 mm × 148 to 305 mm (2.99 to 8.5 inches × 5.83 to 12.01 inches)				

[†] The paper size can be specified using the printer driver. However, feeding paper depends on the paper type.

Smoothness

The paper should have a smooth, uncoated surface. Paper with a rough or sandy surface can cause voids in the printed output. Paper that is too smooth can cause multiple feeding and fogging problems. (Fogging is a gray background effect.)

Basis Weight

Basis weight is the weight of paper expressed in grams per square meter (g/m²). Paper that is too heavy or too light may cause feed errors or paper jams as well as premature wear of the product. Uneven weight of paper, namely uneven paper thickness may cause multiple-sheet feeding or print quality problems such as blurring because of poor toner fusing.

The recommended basis weight is between 60 and 120 g/m² (16 and 32 lb/ream) for the cassette and between 60 and 220 g/m² (16 and 59 lb/ream) for the MP tray.

Paper Weight Equivalence Table

The paper weight is listed in pounds (lb) and metric grams per square meter (g/m²). The shaded part indicates the standard weight.

U. S. Bond Weight (lb)	Europe Metric Weight (g/m ²)	U. S. Bond Weight (lb)	Europe Metric Weight (g/m ²)
16	60	32	120
17	64	34	128
20	75	36	135
21	80	39	148
22	81	42	157
24	90	43	163
27	100	47	176
28	105	53	199

Thickness

The paper used with the machine should be neither extremely thick nor extremely thin. If you are having problems with paper jams, multiple feeds, and faint printing, the paper you are using may be too thin. If you are having problems with paper jams and blurred printing the paper may be too thick. The correct thickness is 0.086 to 0.110 mm (3.4 to 4.3 mils).

Moisture Content

Moisture content is defined as the percent ratio of moisture to the dry mass of the paper. Moisture can affect the paper's appearance, feed ability, curl, electrostatic properties, and toner fusing characteristics.

The moisture content of the paper varies with the relative humidity in the room. When the relative humidity is high and the paper absorbs moisture, the paper edges expand, becoming wavy in appearance. When the relative humidity is low and the paper loses moisture, the edges shrink and tighten, and print contrast may suffer.

Wavy or tight edges can cause jams and alignment anomalies. The moisture content of the paper should be 4 to 6 %.

To ensure correct moisture content, it is important to store the paper in a controlled environment. Some tips on moisture control are:

- Store paper in a cool, dry location.
- Keep the paper in its wrapping as long as possible. Re-wrap paper that is not in use.
- Store paper in its original carton. Place a pallet etc. under the carton to separate it from the floor.
- After removing paper from storage, let it stand in the same room as the machine for 48 hours before use.
- Avoid leaving paper where it is exposed to heat, sunlight, or damp.



Note When using coated paper, be aware that the sheets will stick together in a very humid environment.

Paper Grain

When paper is manufactured, it is cut into sheets with the grain running parallel to the length (long grain) or parallel to the width (short grain). Short grain paper can cause feeding problems in the machine. All paper used in the machine should be long grain.

Other Paper Properties

Porosity: Indicates the density of paper fiber.

Stiffness: Limp paper may buckle in the machine, resulting in paper jams.

Curl: Most paper naturally tends to curl one way if left unpacked.

Electrostatic discharge: During the printing process the paper is electrostatically charged to attract the toner. The paper must be able to release this charge so that printed sheets do not cling together in the *Output Tray*.

Whiteness: The contrast of the printed page depends on the whiteness of the paper. Whiter paper provides a sharper, brighter appearance.

Quality control: Uneven sheet size, corners that are not square, ragged edges, welded (uncut) sheets, and crushed edges and corners can cause the machine to malfunction in various ways. A quality paper supplier should take considerable care to ensure that these problems do not occur.

Packaging: Paper should be packed in a sturdy carton to protect it from damage during transport. Quality paper obtained from a reputable supplier is usually correctly packaged.



Note You might see the printer emitting steam in the area around the top tray if you use damp paper, but it is safe to continue printing.

Special Paper

The following types of special paper can be used:

Paper Type to be Used	Paper Type to be Selected
Overhead projector transparencies	Transparency
Rough paper	Rough
Thin paper (60 to 64 g/m ²)	Vellum
Label	Labels
Recycled paper	Recycled
Preprinted paper	Preprinted
Bond paper	Bond
Postcards	Cardstock
Colored paper	Color
Prepunched paper	Prepunched
Letterhead	Letterhead
Envelopes	Envelope
Thick paper (120 to 220 g/m ²)	Thick
High-quality paper	High Quality
Custom	Custom 1~8

Use paper that is sold specifically for use with copiers or printers (heat-fusing type). When using transparencies, labels, thin paper, postcards, or thick paper, feed the paper from the *MP tray*. For details, refer to *MP Tray Set. (MP tray settings)* on page 4-26.

Since the composition and quality of special paper vary considerably, special paper is more likely than white bond paper to give trouble during printing. No liability will be assumed if moisture and so forth given off during printing on special paper causes harm to the machine or operator.



Note Before purchasing any type of special paper, test a sample on the machine and check that printing quality is satisfactory.

Transparency

Transparencies must be able to withstand the heat of fusing during the printing process. The recommended transparency product is 3M CG3700 (Letter, A4).

The table below lists the specifications for transparency:

Item	Specification
Tolerance of heat	Must tolerate at least 190 °C (374 °F)
Thickness	0.100 to 0.110 mm (3.9 to 4.3 mils)
Material	Polyester
Dimensional accuracy	±0.7 mm (±0.0276 inches)
Squareness of corners	90° ±0.2°

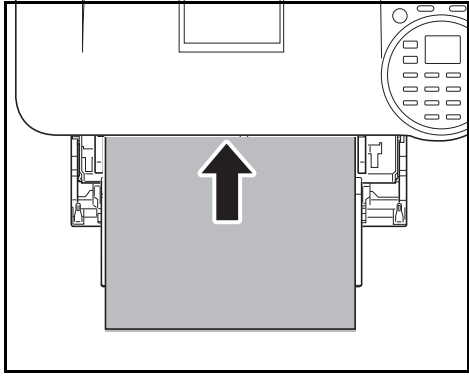

To prevent printing problems, feed transparencies into the printer one sheet at a time from the *MP tray*. Always load the transparencies vertically (with the long edge towards the printer).

If the transparencies have rough edges on the back, it may cause a paper jam. Remove the rough edges, reverse the sides, feed the sheet from the opposite edge, or flip the sheet over.

When unloading transparencies (e.g., for clearing jams), hold them carefully by the edges to avoid leaving fingerprints on them.

Labels

Labels must be fed from the *MP tray*.

The basic rule for printing on adhesive labels is that the adhesive must never come into contact with any part of the machine. Adhesive paper sticking to the drum or rollers will damage the machine.

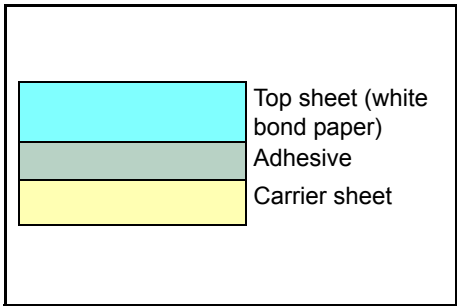

Label paper has a structure comprising of three layers, as shown in the diagram. The top sheet is printed on. The adhesive layer consists of pressure-sensitive adhesives. The carrier sheet (also called the linear or backing sheet) holds the labels until used. Due to the complexity of its composition, adhesive-backed label paper is particularly likely to give printing problems.

Adhesive label paper must be entirely covered by its top sheet, with no spaces between the individual labels. Labels with spaces in between are liable to peel off, causing serious paper jam problems.

Some label paper is manufactured with an extra margin of top sheet around the edge. Do not remove the extra top sheet from the carrier sheet until after printing is finished.

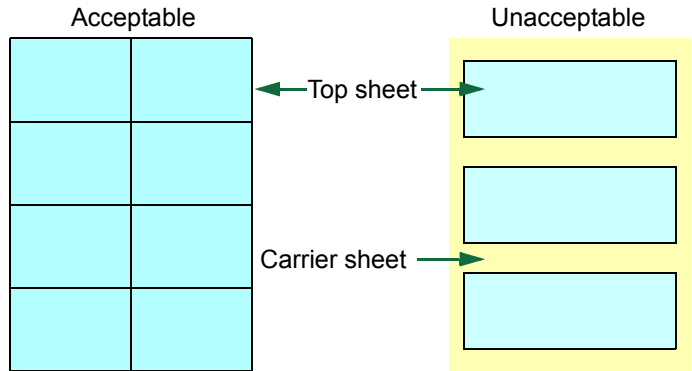

The table below lists the specifications for adhesive label paper.

Item	Specification
Weight of top sheet	44 to 74 g/m ² (12 to 20 lb/ream)
Composite weight	104 to 151 g/m ² (28 to 40 lb/ream)
Thickness of top sheet	0.086 to 0.107 mm (3.9 to 4.2 mils)
Composite thickness	0.115 to 0.145 mm (4.5 to 5.7 mils)
Moisture content	4 to 6 % (composite)

Postcards

Fan the stack of postcards and align the edges before loading them in the MP tray. Make sure the postcards you are going to set are not curled. Feeding curled postcards may cause paper jams.

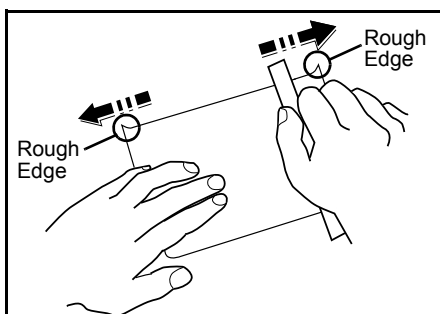

Some postcards have rough edges on the back (those are created when the paper is cut). In this case, put the postcards on a flat place and rub the edges with, for example, a ruler to smooth them.

Envelopes

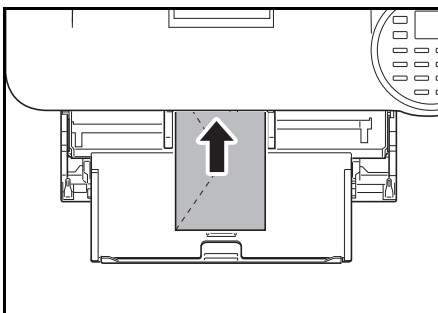

Envelopes should be fed from the MP tray with the print-side up or the optional paper feeder (PF-320) with the print-side down.

IMPORTANT Do not load paper above the load limits located on the paper width guide of the optional paper feeder.

For FS-2100D and FS-2100DN, set envelope mode. Refer to *Switching to Envelop Mode (FS-2100D/FS-2100DN)* on page 2-27.

Since the composition of an envelope is more complex than that of ordinary paper, it is not always possible to ensure consistent printing quality over the entire envelope surface.

Normally, envelopes have a diagonal grain direction. Refer to *Paper Grain* on page A-17. This direction can easily cause wrinkles and creases when envelopes pass through the printer. Before purchasing envelopes, make a test print to check whether the printer accepts the envelope.

- Do not use envelopes that have an encapsulated liquid adhesive.
- Avoid a long printing session for envelopes only. Extended envelope printing can cause premature printer wear.
- If jams occur, try setting a lesser number of envelopes on the MP tray.
- To avoid jams caused by curled envelopes, stack no more than 5 printed envelopes on the top tray.

Thick Paper

Fan the stack of paper and align the edges before loading them in the MP tray. Some types of paper have rough edges on the back (those are created when the paper is cut). In this case, put the paper on a flat place and rub the edges once or twice with, for example, a ruler to smooth them. Feeding rough edged paper may cause paper jams.

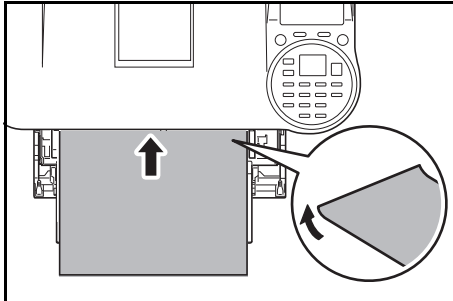

 **Note** If the paper jams even after you smooth it out, load the paper in the *MP tray* with the leading edge rose up a few millimeters as shown in the illustration.

Colored Paper

Colored paper should satisfy the same conditions as white bond paper, refer to *Paper Specifications on page A-13*. In addition, the pigments used in the paper must be able to withstand the heat of fusing during the printing process (up to 200 °C or 392 °F).

Preprinted Paper

Preprinted paper should satisfy the same conditions as white bond paper, refer to *Paper Specifications on page A-13*. The preprinted ink must be able to withstand the heat of fusing during the printing process, and must not be affected by silicone oil. Do not use paper with any kind of surface treatment, such as the type of paper commonly used for calendars.

Recycled Paper

Select recycled paper that meets the same specifications as the white bond paper except for whiteness, refer to *Paper Specifications on page A-13*.



Note Before purchasing recycled paper, test a sample on the machine and check that the printing quality is satisfactory.

Paper Type

The printer is capable of printing under the optimum setting for the type of paper being used.

Setting the paper type for the paper source from the printer's operation panel will cause the printer to automatically select the paper source and print in the mode best suited to that type of paper.

A different paper type setting can be made for each paper source including the MP tray. Not only can preset paper types be selected, but it is also possible for you to define and select customized paper types. Refer to *Media Type Set. (Paper type settings)* on page 4-35. The following types of paper can be used.

Yes: Can be stored No: Cannot be stored

Paper Type	Paper Source				
	MP Tray / Optional Bulk Paper Feeder PF-315+	Paper Cassette	Optional Paper Feeder PF-320	Paper Weight	Duplex Path
Plain	Yes	Yes	Yes	Normal 2	Yes
Transparency	Yes	No	No	Extra Heavy	No
Preprinted	Yes	Yes	Yes	Normal 2	Yes
Labels	Yes	No	No	Heavy 1	No
Bond	Yes	Yes	Yes	Normal 3	Yes
Recycled	Yes	Yes	Yes	Normal 2	Yes
Vellum	Yes	No	No	Light	No
Rough	Yes	Yes	Yes	Normal 3	Yes
Letterhead	Yes	Yes	Yes	Normal 3	Yes
Color	Yes	Yes	Yes	Normal 3	Yes
Prepunched	Yes	Yes	Yes	Normal 2	Yes
Envelope	Yes	No	Yes	Heavy 3	No
Cardstock	Yes	No	No	Heavy 3	No
Thick	Yes	No	No	Heavy 3	No
High Quality	Yes	Yes	Yes	Normal 2	Yes
Custom 1 (to 8) [†]	Yes	Yes	Yes	Normal 2	Yes

[†] This is a paper type defined and registered by the user. Up to eight types of user settings may be defined. For details, refer to *Media Type Set. (Paper type settings)* on page 4-35.

Specifications

 **Note** Specifications are subject to change without notice.

Machine

Item		Description				
		FS-2100D	FS-2100DN	FS-4100DN	FS-4200DN	FS-4300DN
Type		Desktop				
Printing Method		Electrophotography by semiconductor, single drum system				
Paper Weight	Cassette	60 to 120 g/m ²				
	MP Tray	60 to 220 g/m ² , 230 g/m ² (Cardstock)				
Paper Types	Cassette	Plain, Preprinted, Bond, Recycled, Rough, Letterhead, Color, Prepunched, High Quality, and CUSTOM 1 (to 8)				
	MP Tray	Plain, Transparency, Preprinted, Labels, Bond, Recycled, Vellum, Rough, Letterhead, Color, Prepunched, Envelope, Cardstock, Thick, High Quality, and CUSTOM 1 (to 8)				
Paper Sizes	Cassette	Envelope C5, Executive, 8 1/2 × 11"(Letter), 8 1/2 × 14"(Legal), A4, B5, A5, ISO B5, Oficio II, 216 × 340 mm, 16K, Statement, Folio, and Custom	Envelope DL, Envelope C5, Executive, 8 1/2 × 11"(Letter), 8 1/2 × 14"(Legal), A4, B5, A5, A6, B6, ISO B5, Oufuku Hagaki, Oficio II, 216 × 340 mm, 16K, Statement, Folio, and Custom			
	MP Tray	Envelope Monarch, Envelope #10, Envelope DL, Envelope C5, Executive, 8 1/2 × 11"(Letter), 8 1/2 × 14"(Legal), A4, B5, A5, A6, B6, Envelope #9, Envelope #6, ISO B5, Hagaki, Oufuku Hagaki, Oficio II, 216 × 340 mm, 16K, Statement, Folio, Youkei 2, Youkei 4, and Custom				
Magnification ratio		20 to 500%, 1% increments				
Printing Speeds	Simplex	A4: 40 ppm B5: 33 ppm A5: 22 ppm A6: 22 ppm Letter: 42 ppm Legal: 33 ppm	A4: 45 ppm B5: 36 ppm A5: 23 ppm A6: 23 ppm Letter: 47 ppm Legal: 38 ppm	A4: 50 ppm B5: 40 ppm A5: 27 ppm A6: 27 ppm Letter: 52 ppm Legal: 42 ppm	A4: 60 ppm B5: 48 ppm A5: 32 ppm A6: 32 ppm Letter: 62 ppm Legal: 50 ppm	
	Duplex	A4: 20 ppm B5: 16.5 ppm A5: 11 ppm Letter: 21 ppm Legal: 16.5 ppm	A4: 32 ppm B5: 25 ppm A5: 16 ppm Letter: 33 ppm Legal: 16 ppm	A4: 36 ppm B5: 28 ppm A5: 19 ppm Letter: 37 ppm Legal: 21 ppm	A4: 43 ppm B5: 34 ppm A5: 23 ppm Letter: 44 ppm Legal: 25 ppm	
First Print Time (A4, feed from Cassette)		9 seconds or less				
Warm-up Time (22°C, 60%RH)	Power On	15 seconds or less			20 seconds or less	25 seconds or less
	Sleep [†]	15 seconds or less			20 seconds or less	25 seconds or less

Item		Description				
		FS-2100D	FS-2100DN	FS-4100DN	FS-4200DN	FS-4300DN
Paper Capacity	Cassette	500 sheets (80 g/m ²)				
	MP Tray	100 sheets (80 g/m ²)				
Output Tray Capacity	Top Tray	250 sheets (67 g/m ²)		500 sheets (67 g/m ²)		
	Face-up Tray	–		250 sheets (67 g/m ²)		
Continuous printing		1 to 999 sheets				
Resolution		Fine 1200 mode, Fast 1200 mode, 600 dpi, 300 dpi				
Operation Environment	Temperature	10 to 32.5 °C (50 to 90.5 °F)				
	Relative Humidity	15 to 80 %				
	Altitude	2,500 m (8,202 feet) maximum				
	Illumination	1,500 lux maximum				
Controller		PowerPC465	PowerPC465, ARM9			
Operating Systems		Windows XP, Windows Server 2003/R2, Windows Vista, Windows Server 2008/R2, Windows 7, Apple Macintosh OS 10.4 or later				
Interface	Standard	USB Interface Connector: 1 USB Host: 2 eKUIO slot:1	USB Interface Connector: 1 USB Host: 2 Network interface: 1 (10 BASE-T/100 BASE-TX/1000 BASE-T) eKUIO slot:1			
	Option	HD-6, IB-50, IB-51, IB-32				
PDL		PRESCRIBE				
Emulation		PCL6, IBM Proprinter, EPSON LQ-850, Line Printer, KPDL, KPDL(Auto)				
Memory	Standard	128 MB	256 MB			
	Maximum	1152 MB	1280 MB			
Dimensions (W × D × H)		380 × 416 × 285 mm 15 × 16 3/8 × 11-1/4"		380 × 416 × 320 mm 15 × 16 3/8 × 12 5/8"		
Weight		Approx. 13.5 kg (29.7 lbs)		Approx. 14.6 kg (32.12 lbs)		
Power Requirement		120 V, 60 Hz, 8.3 A 220-240 V, 50 Hz/60 Hz, 4.4 A		120 V, 60 Hz, 9.7 A 220-240 V, 50 Hz/60 Hz, 5.2 A		

Item		Description				
		FS-2100D	FS-2100DN	FS-4100DN	FS-4200DN	FS-4300DN
Power Consumption (Standard)	Maximum	925 W (U.S.A./Canada) 986 W (European countries)	928 W (U.S.A./Canada) 995 W (European countries)	1148 W (U.S.A./Canada) 1218 W (European countries)	1153 W (U.S.A./Canada) 1222 W (European countries)	1164 W (U.S.A./Canada) 1238 W (European countries)
	During Printing	632 W (U.S.A./Canada) 564 W (European countries)	593 W (U.S.A./Canada) 584 W (European countries)	644 W (U.S.A./Canada) 618 W (European countries)	690 W (U.S.A./Canada) 677 W (European countries)	783 W (U.S.A./Canada) 757 W (European countries)
	During Standby	10.6 W (U.S.A./Canada) 11.5 W (European countries)	11.7 W (U.S.A./Canada) 12.2 W (European countries)	12.7 W (U.S.A./Canada) 13.3 W (European countries)	12.5 W (U.S.A./Canada) 12.8 W (European countries)	12.5 W (U.S.A./Canada) 13.1 W (European countries)
	Sleep Mode [†]	2.6 W (U.S.A./Canada) 3.0 W (European countries)	1.7 W (U.S.A./Canada) 1.9 W (European countries)	1.8 W (U.S.A./Canada) 1.6 W (European countries)	1.8 W (U.S.A./Canada) 1.6 W (European countries)	1.8 W (U.S.A./Canada) 1.6 W (European countries)
	Power Off	0.5 W or less				
Power Consumption (With options)	Maximum	954 W (U.S.A./Canada) 1015 W (European countries)	957 W (U.S.A./Canada) 1021 W (European countries)	1180 W (U.S.A./Canada) 1256 W (European countries)	1185 W (U.S.A./Canada) 1256 W (European countries)	1204 W (U.S.A./Canada) 1275 W (European countries)
	During Printing	683 W (U.S.A./Canada) 645 W (European countries)	632 W (U.S.A./Canada) 627 W (European countries)	696 W (U.S.A./Canada) 679 W (European countries)	761 W (U.S.A./Canada) 715 W (European countries)	866 W (U.S.A./Canada) 811 W (European countries)
	During Standby	17.0 W (U.S.A./Canada) 15.7 W (European countries)	19.2 W (U.S.A./Canada) 19.9 W (European countries)	19.4 W (U.S.A./Canada) 20.0 W (European countries)	19.1 W (U.S.A./Canada) 19.6 W (European countries)	18.8 W (U.S.A./Canada) 19.6 W (European countries)
	Sleep Mode [†]	5.2 W (U.S.A./Canada) 5.9 W (European countries)	4.7 W (U.S.A./Canada) 5.1 W (European countries)	4.9 W (U.S.A./Canada) 4.7 W (European countries)	5.1 W (U.S.A./Canada) 4.6 W (European countries)	4.8 W (U.S.A./Canada) 4.8 W (European countries)
	Power Off	0.5 W or less				

Item	Description				
	FS-2100D	FS-2100DN	FS-4100DN	FS-4200DN	FS-4300DN
Option	Expanded memory, Paper Feeder (500-sheet × 4), SSD (HD-6), SD Card, Network Interface Kit (IB-50), Wireless Network Interface Kit (IB-51), Parallel Interface Kit (IB-32), Bulk Paper Feeder (PF-315+)		Expanded memory, Paper Feeder (500-sheet × 4), SSD (HD-6), SD Card, Network Interface Kit (IB-50), Wireless Network Interface Kit (IB-51), Parallel Interface Kit (IB-32), Bulk Paper Feeder (PF-315+), Faceup Output Tray (PT-320)		

† The value is at Energy Saver mode (default).

Paper Feeder (PF-320) (Option)

Item	Description
The maximum number of paper cassettes	4
Paper size	Envelope Monarch, Envelope #10, Envelope DL, Envelope C5, Executive, 8 1/2 × 11"(Letter), 8 1/2 × 14"(Legal), A4, B5, A5, B6, Envelope #9, Envelope #6, ISO B5, Oufuku Hagaki, Oficio II, 216 × 340 mm, 16K, Statement, Folio, Youkei 2, Youkei 4, and Custom
Paper type	Plain, Preprinted, Bond, Recycled, Rough, Letterhead, Color, Prepunched, Envelope, High Quality, and CUSTOM 1 (to 8)
Paper capacity	500 sheets (80 g/m ²)
Dimensions (W × D × H)	380 × 410 × 121 mm 15 × 16 1/8 × 4 3/4"
Weight	4.0 kg or less (8.8 lbs or less)

Bulk Paper Feeder (PF-315+) (Option)

Item		Description
Paper size		Envelope Monarch, Envelope #10, Envelope DL, Envelope C5, Executive, Letter, A4, B5, A5, A6, B6, Envelope #9, Envelope #6, ISO B5, Custom, Hagaki, Oufuku Hagaki, 16K, Statement, Youkei 2 and Youkei 4
Paper type		Plain, Transparency, Preprinted, Labels, Bond, Recycled, Vellum, Rough, Letterhead, Color, Prepunched, Envelope, Cardstock, Thick, High Quality, and CUSTOM 1 (to 8)
Paper capacity		2,000 sheets (80 g/m ²)
Noise (Lwad)		FS-2100D/FS-2100DN: 70 dB(A) FS-4100DN: 71 dB(A) FS-4200DN: 72 dB(A) FS-4300DN: 74 dB(A) (At feeding the standard size paper)
Dimensions (W × D × H)	PF-315+	352 × 345 × 376 mm 13 7/8 × 13 5/8 × 14 7/8"
	PB-325	380 × 705.6 × 183.7 mm 15 × 27 3/4 × 7 3/4"
Weight	PF-315+	7.7 kg or less (16.94 lbs or less)
	PB-325	6.5 kg or less (14.3 lbs or less)

SSD (HD-6) (Option)

Item	Description
Capacity	32 GB
Power supply	From the machine

Network Interface Kit (IB-50) (Option)

Item	Description	
CPU	SoC 88F6180	
RAM	64 MBytes	
Flash ROM	16 MBytes	
Connectors	10BASE-T / 100BASE-TX / 1000BASE-T	
Printer interface	eKUIO (5.0V)	
Operating system	Windows 2000(32bit) / XP (32bit/64bit) / Vista(32bit/64bit) / 7(32bit/64bit) / Server 2003(32bit/64bit) / Server 2008(32bit/64bit) NetWare 3.x. / 4.x. / 5.x. / 6.x MacOS 9.x / Mac OS X(PowerPC:Ver 10.3.x-Ver 10.5.5 / Intel:Ver 10.4.4-Ver 10.6.x) UNIX	
Network protocols	IPv6	Apple Bonjour Compatible, DHCPv6, DNSv6, FTP, FTPS, HTTP, HTTPS, ICMPv6, IKEv1, IPP, IPPS, Kerberos, LDAP, LPD, POP3, RawPort, SLP, SMTP, SNMP, SNMPv1/v2c/v3, SNTP, ThinPrint
	IPv4	Apple Bonjour Compatible, BOOTP, DHCP, DNS, FTP, FTPS, HTTP, HTTPS, ICMP, IPP, IPPS, KCP, Kerberos, LDAP, LPD, NetBIOS over TCP/IP, POP3, POP3 over SSL, RawPort, SLP, SMTP, SNMP, SNMPv1/v2c/v3, SNTP, ThinPrint, WINS
	Other	AppleTalk, IPX/SPX, LLTD, NetBEUI, NetWare (NDS/Bindery)
Security protocols	EAP-TLS, EAP-TTLS, EAP-FAST, IKE, PEAP, SNMPv3, SSL/TLS (HTTPS)	
Operating conditions	0 to 70°C, 20 to 80 % RH, no condensation	
Storage conditions	-20 to 50°C, 20 to 90 % RH, no condensation	
EMI conformity	FCC Class B (USA), CE (EU), VCCI Class B (Japan)	

Wireless Network Interface Kit (IB-51) (Option)

Item		Description	
CPU		SoC 88F6180	
RAM		64 MBytes	
ROM		16 MBytes	
Wireless network interface	IEEE802.11b	Frequency	2.4GHz
		Transmission system	DS-SS
		Transmission speed	1 / 2 / 5.5 / 11 (Mbps)
		Channel	1-11ch
	IEEE802.11g	Frequency	2.4GHz
		Transmission system	OFDM
		Transmission speed	6 / 9 / 12 / 18 / 24 / 36 / 48 / 54 (Mbps)
		Channel	1-11ch
	IEEE802.11n	Frequency	2.4GHz
		Transmission system	OFDM
		Transmission speed	Max 300Mbps
		Channel	1-11ch
	Authentication method		Open System / Shard Key / WPA / WPA2
	Encryption mode		None / WEP(64bit / 128bit) / TKIP / AES When running in IEEE 802.11n, only AES is supported.
Antenna		Non-directional antenna × 2	
Printer interface		eKUIO (5.0V)	
Operating system		Windows 2000(32bit) / XP (32bit/64bit) / Vista(32bit/64bit) / 7(32bit/64bit) / Server 2003(32bit/64bit) / Server 2008(32bit/64bit) NetWare 3.x / 4.x / 5.x / 6.x MacOS 9.x / Mac OS X(PowerPC:Ver 10.3.x-Ver 10.5.5 / Intel:Ver 10.4.4-Ver 10.6.x) UNIX	

Item		Description
Network protocols	IPv6	Apple Bonjour Compatible, DHCPv6, DNSv6, FTP, FTPS, HTTP, HTTPS(IPPS), ICMPv6, IKEv1, IPP, IPPS, Kerberos, LDAP, LPD, POP3, RawPort, SLP, SMTP, SNMP, SNMPv1/v2c/v3, SNTP, ThinPrint
	IPv4	Apple Bonjour Compatible, BOOTP, DHCP, DNS, FTP, FTPS, HTTP, HTTPS, ICMP, IPP, IPPS, KCP, Kerberos, LDAP, LPD, NetBIOS over TCP/IP, POP3, POP3 over SSL, RawPort, SLP, SMTP, SNMP, SNMPv1/v2c/v3, SNTP, ThinPrint, WINS
	Other	AppleTalk, IPX/SPX, LLTD, NetBEUI, NetWare (NDS/Bindery)
Security protocols		EAP-TLS, IKE, PEAP, SNMPv3, SSL/TLS (HTTPS)
Operating conditions		0 to 60 °C, 20 to 80 % RH, no condensation
Storage conditions		-20 to 50 °C, 20 to 90 % RH, no condensation
EMI conformity		FCC Class B (USA), CE (EU), VCCI Class B (Japan)

Parallel Interface Kit (IB-32) (Option)

Item	Description
Installation Environment	Conforms to the machine's installation environment
Interface	Parallel Interface × 1 (IEEE-1284 compliant)
Power supply	From the machine

Environmental Specifications

Item	Description	
Time to Sleep mode (default setting)	1 minute	
Recovery time from Sleep mode	FS-2100D FS-2100DN FS-4100DN	15 seconds or less
	FS-4200DN	20 seconds or less
	FS-4300DN	25 seconds or less
Duplexing	Standard	
Paper supply capability	100% recycled paper may be used.	

 **Note** Consult your dealer or service representative for recommended paper types.

Glossary

Additional memory

An additional memory (optional) is used for increasing the memory capacity of this machine. For DIMM that can be used in this machine, contact your service technician.

AppleTalk

AppleTalk offers file sharing and printer sharing and it also enables you to utilize application software that is on another computer on the same AppleTalk network.

Auto-IP

Auto-IP is a module that enables dynamic IPv4 addresses to be assigned to a device on startup. However, DHCP requires a DHCP server. Auto-IP is a server-less method of choosing an IP address. IP addresses between 169.254.0.0 to 169.254.255.255 are reserved for Auto-IP and assigned automatically.

Bonjour

Bonjour, also known as zero-configuration networking, is a service that automatically detects computers, devices and services on an IP network. Bonjour, because an industry-standard IP protocol is used, allows devices to automatically recognize each other without an IP address being specified or DNS server being set. Bonjour also sends and receives network packets by UDP port 5353. If a firewall is enabled, the user must check that UDP port 5353 is left open so that Bonjour will run correctly. Some firewalls are set up so as to reject only certain Bonjour packets. If Bonjour does not run stably, check the firewall settings and ensure that Bonjour is registered on the exceptions list and that Bonjour packets are accepted. If you install Bonjour on Windows XP Service Pack 2 or later, the Windows firewall will be set up correctly for Bonjour.

Custom Box

The Custom Box function stores print data for each individual user on the printer and allows the user to print single or multiple copies of the stored data later using the printer's operation panel.

DDSN (Dynamic Domain Name System)

A Dynamic Domain Name System (DDSN) is a system for providing a fixed host name for IP addresses which change dynamically.

By updating the correspondence between the host name registered and the IP address as the IP address changes, it is possible to connect with the same host name even when the IP address has changed.

Default Gateway

This indicates the device, such as a computer or router, which serves as the entrance/exit (gateway) for accessing computers outside the network that you are on. When no specific gateway is designated for a destination IP address, data is sent to the host designated as the Default Gateway.

DHCP (Dynamic Host Configuration Protocol)

Dynamic Host Configuration Protocol (DHCP) that automatically resolves IP addresses, subnet masks, and gateway addresses on a TCP/IP network. DHCP minimizes the load of network management employing a large number of client computers because it relieves individual clients including printers from the IP address being assigned.

dpi (dots per inch)

A unit for resolution, representing the number of dots printed per inch (25.4 mm).

EcoPrint

This is a printing mode that reduces toner consumption. Pages printed in the EcoPrint mode are lighter than pages printed in the normal mode.

Emulation

The function to interpret and execute other printers' page description languages.

Form Feed Timeout

While data is being sent to a printer, some pauses may occur. At this time, the printer waits for the next data without making a page break. Form feed timeout is a function to wait only a preset amount of time before it executes an automatic page break. After the waiting period begins, once the designated amount of time is exceeded, the printer will automatically process the currently received data and print it out. If the machine has received no print data for the last page, the printer ends processing of that job without outputting paper.

IP Address (Internet Protocol Address)

An Internet protocol address is a unique number that represents a specific computer or related device on the network. The format of an IP address is four sets of numbers separated by dots, e.g. 192.168.110.171. Each number should be between 0 and 255.

IPP

IPP (Internet Printing Protocol) is a standard that uses TCP/IP networks such as the Internet to enable print jobs to be sent between remote computers and printers. IPP is an extension of the HTTP protocol used to view websites and enables printing to be carried out via routers on printers in remote locations. It also supports the HTTP authentication mechanisms along with SSL server and client authentication as well as encryption.

Job Box

The Job Box function stores print data on the printer and allows users to print single or multiple copies of the stored data later using the printer's operation panel.

KPDL

Kyocera's PostScript page description language compatible with Adobe PostScript Level 3.

Multi Purpose (MP) Tray

Use this tray instead of the cassettes when printing onto envelopes, Hagaki, transparencies, or labels.

NetBEUI (NetBIOS Extended User Interface)

An interface, developed by IBM in 1985, as an update from NetBIOS. It enables more advanced functions on smaller networks than other protocols such as TCP/IP, etc. It is not suitable for larger networks due to lack of routing capabilities to choose the most appropriate routes. NetBEUI has been adopted by IBM for its OS/2 and Microsoft for its Windows as a standard protocol for file sharing and printing services.

NetWare

Novell's network management software that is able to run on a variety of operating systems.

Outline font

With outline fonts, character outlines are represented with numerical expressions and fonts can be enlarged or reduced in different ways by changing the numeric values of those expressions. Printing remains clear even if you enlarge fonts, since the characters are defined with outlines represented with numerical expressions. You can specify the font size in steps of 0.25 points up to 999.75 points.

POP3 (Post Office Protocol 3)

A standard protocol to receive E-mail from the server in which the mail is stored on the Internet or an intranet.

PostScript

A page description language developed by Adobe Systems. It enables flexible font functions and highly-functional graphics, allowing higher quality printing. The first version called Level 1 was launched in 1985, followed by Level 2 that enabled color

printing and two-byte languages (e.g. Japanese) in 1990. In 1996, Level 3 was released as an update for the Internet access and PDF format as well as gradual improvements in implementation technologies.

PPM (Prints Per Minute)

This indicates the number of A4 size printouts made in one minute.

Printer driver

The software to enable you to print data created on any application software. The printer driver for the machine is contained in the *Product Library* disc enclosed in the package. Install the printer driver on the computer connected to the machine.

RA (Stateless)

The IPv6 router communicates (transmits) information such as the global address prefix using ICMPv6. This information is the Router Advertisement (RA). ICMPv6 stands for Internet Control Message Protocol, and is an IPv6 standard defined in the RFC 2463 "Internet Control Message Protocol (ICMPv6) for the Internet Protocol Version 6 (IPv6) Specification".

SD/SDHC Memory Card

An SD Memory Card is a removable storage media. It is nonvolatile semiconductor memory where the data remains even when the power supply is cut. The maximum memory capacity is 2 GB.

SDHC memory cards are a higher specification of SD memory cards. These memory cards have bigger capacities than SD memory cards and have a guaranteed minimum transfer speed.

As the file system was changed to FAT32, up to a maximum of 32 GB is supported.

Sleep mode

This mode is provided to save power. It is activated when the machine is not used for a preset period of time. In this mode, power is reduced to the minimum. The default setting can be changed.

SMTP (Simple Mail Transfer Protocol)

A protocol for E-mail transmission over the Internet or an intranet. It is used for transferring mail between mail servers as well as for sending mail from clients to their servers.

SSD (Solid State Drive)

An SSD is a media for data storage using flash memory.

Whereas HDD generally use magnetic discs as the storage media, SDD are a storage media which use semiconductors.

Compared with HDD, on which a head reads from the magnetic disk, the merits of SSD are that they can read data at higher speeds, they are resistant to vibrations, and they do not require motors, which mean that they consume less electricity and there is no drive noise.

Status page

This lists machine conditions, such as the machine's memory, the total number of prints and paper source settings. You can print the status page from the operation panel.

Subnet Mask

The subnet mask is a way of augmenting the network address section of an IP address. A subnet mask represents all network address sections as 1 and all host address sections as 0. The number of bits in the prefix indicates the length of the network address. The term "prefix" refers to something added to the beginning and, in this context, indicates the first section of the IP address. When an IP address is written, the length of the network address can be indicated by the prefix length after a forward slash (/). For example, "24" in the address "133.210.2.0/24". In this way, "133.210.2.0/24" denotes the IP address "133.210.2.0" with a 24-bit prefix (network section). This new network address section (originally part of the host address) made possible by the subnet mask is referred to as the subnet address. When you enter the subnet mask, be sure to set the DHCP setting to Off.

TCP/IP (Transmission Control Protocol/Internet Protocol)

TCP/IP is a suite of protocols designed to define the way computers and other devices communicate with each other over a network.

TCP/IP (IPv6)

TCP/IP (IPv6) is based on the current Internet protocol, TCP/IP (IPv4). IPv6 is the next-generation Internet protocol and expands the available address space, which resolves the problem of the lack of addresses under IPv4, while also introducing other improvements such as additional security functionality and the capacity to prioritize data transmission.

USB (Universal Serial Bus)

An interface standard for low to middle speed serial interfaces. This printer supports Hi-Speed USB. The maximum transfer rate is 480 Mbps and the maximum cable length is 5 meters (16 feet).

Index

A

Administrator	4-116
Alternative Emulation	4-44
Appendix	A-1
AppleTalk	Glossary-1
Auto-IP	Glossary-1

B

Bonjour	Glossary-1
Bulk Paper Feeder	A-12
Bulk paper feeder	
clearing paper jams	8-23
Buzzer	4-79

C

Canceling a Printing Job	3-2, 4-4
Card Authentication Kit (B)	A-12
Cassette (1 to 5) Settings	
Cassettes	4-28
Paper Weight	4-35
Cassette 1	1-2
Character Entry Method	A-2
Cleaning	
printer	7-8
Clearing paper jams	
bulk paper feeder	8-23
Duplex unit	8-21
inside the printer	8-22
MP tray	8-19
paper cassette	8-20
paper feeder	8-20
rear unit	8-23
Code Set	4-47
Colored Paper	A-21
Command Center RX	2-17
Copies	4-50
Counter	4-25
CR Action	4-51
Custom Box	5-4
Printer driver	5-34
Custom Paper Size	
Duplex Printing	4-37
Paper Size	4-31
Paper Weight	4-36

D

Data Security	4-106
Security Password	4-107
SSD Initialization	4-107
Data Security Kit	A-12
Date Setting	4-76
DDSN	Glossary-1
Developer Unit	1-3
DHCP	Glossary-1

DIMM	A-5
Display backlight	4-84
Display brightness	4-83
Document Box	5-2
Document Box default screen	4-75
Duplex Front Cover	1-3
Duplex Printing	4-41
Binding Modes	4-41
Permitted with custom paper	4-38
Duplex unit	
clearing paper jams	8-21
Dynamic Domain Name System (DDNS)	2-18

E

EcoPrint	4-48
Emulation	4-43
Error Report	4-43
Energy Star Program	ix
Envelop Mode	2-27
Envelope Switch	1-4
Error Handling	4-84
Duplex Paper Error	4-85
MP Tray Empty	4-85
Paper Mismatch	4-85
Error Messages	8-5
Expansion memory module	
option	A-5

F

Faceup Output Tray	A-11
Font	4-45
Front Cover	1-3
Fuser Cover	1-4

I

ID Card Setting	4-118
Indicator	
Attention	1-5, 4-3
Data	1-5, 4-3
Ready	1-5, 4-3
Inside the printer	
clearing paper jams	8-22
Installing Software	2-7
Installing the Printer Driver	
Macintosh	2-10
Windows	2-7
Interface Cover	1-4

J

Job Account setting	4-120
Job Box	5-24
Settings	5-32
Job Name	4-53
Job Retention	5-24

Printer driver	5-34
Private Print	5-28
Proof-and-Hold	5-25, 5-28
Quick Copy	5-25
Quick Copy/Proof-and-Hold	5-25
Stored Job	5-28

K

Key	
[Back] Key	1-5, 4-4
[Cancel] Key	1-5, 4-4
[Clear] Key	1-5, 4-5
[Document Box] Key	1-5, 4-5
[Left Select] Key	1-5, 4-6
[Logout] Key	1-5, 4-4
[MENU] Key	4-4
[Menu] Key	1-5
[OK] Key	1-5, 4-5
[Right Select] Key	1-5, 4-6
Arrow Keys	1-5, 4-5
Numeric Keys	1-5
Numeric keys	4-5
KIR	4-48

L

Labels	A-19
Language	4-74
Left Cover	1-2
Lock Operation Panel	2-19

M

Machine Parts	1-1
Maintenance	4-128, 7-1
Restart	4-128
Memory	
Checking Expansion Memory	A-8
Expansion Memory	A-6
Installation	A-6
Remove	A-7
Message Display	1-5, 4-2
Language	4-74
Status Information	4-2
Message display	
Online help messages	8-19
Mode Selection Menu	4-9
Moving printer	7-10
MP (Multi-Purpose) Tray	1-2
Loading Paper	2-25
Media Type	4-27
Paper Feed source	4-39
Paper Size	4-26
MP tray	
clearing paper jams	8-19
MP Tray Priority	4-39

N

NetBEUI	Glossary-2
Network Interface Connector	1-4

Network Interface Kit	A-10
Network Settings	2-2
Network settings	4-54
Auto-IP	4-55
Bonjour	4-58
Default Gateway	4-57
DHCP	4-55
DHCPv6	4-59
FTP (Server)	4-60
HTTP	4-60
IP Address	4-56
IPv4 Setting	4-55
IPv6 Setting	4-58
LDAP	4-60
LPD	4-60
NetBEUI	4-60
POP3 (E-mail RX)	4-60
Protocol Detail	4-60
RA (Stateless)	4-59
RAW Port	4-60
SMTP (E-mail TX)	4-60
SNMP	4-60
SNMPv3	4-60
Subnet Mask	4-56
TCP/IP	4-54
TCP/IP (IPv6)	4-59

O

Online help messages	
for clearing paper jams	8-19
Operation Panel	1-2, 1-5
Option	
Bulk paper feeder	A-5
expansion memory module	A-5
Faceup output tray	A-5
Network Interface Kit	A-5
Paper feeder	A-5
Parallel Interface Kit	A-5
SD/SDHC Memory Card	A-5, A-9
SSD	A-5
USB flash memory	A-5
Wireless Network Interface Kit	A-5
Option Interface Slot	1-4
Optional Functions	4-130
Optional Network settings	4-62
AppleTalk	4-70
Basic settings	4-69
Communication	4-72
IPSec	4-71
LAN Interface	4-71
MAC address filtering	4-72
Netware	4-70
Restart Network	4-72
TCP/IP Settings	4-69
Wireless Network	4-63
Orientation	4-50
Other Paper Size	4-30

P

Page Setting	4-50
Paper	

Colored Paper	A-21
Envelopes	A-20
Guideline	A-15
Labels	A-19
Loading Envelopes	2-27
Loading Paper into the Cassette	2-22
Loading Paper into the MP Tray	2-25
Media Type	4-27, 4-33, 4-34, 4-35
Minimum and Maximum Paper Sizes	A-14
Other Paper Properties	A-17
Paper Availability	A-13
Paper Sizes	4-26, 4-28, 4-30, A-15
Paper Thickness	4-35
Postcards	A-20
Preprinted Paper	A-21
Recycled Paper	A-21
Resets Customized settings	4-38
Special Paper	A-18
Thick Paper	A-21
Transparency	A-18
Paper Cassette	
Loading Paper	2-22
Non-Standard Paper Size	4-30
Paper Feed source	4-39
Paper Size	4-28
Paper Type	4-29, 4-33
Standard Paper Size	4-28
Paper cassette	
clearing paper jams	8-20
Paper Feed Mode	4-40
Paper Feeder	A-9
Loading Paper	2-22
Paper Feed source	4-39
Paper Size	4-28, 4-30
Paper Type	4-29, 4-33
Paper feeder	
clearing paper jams	8-20
Paper Jams	8-17
Locations	8-17
Message	8-18
Paper Output	4-42
Paper Size Dial	4-29
Paper Stopper	1-2
Paper stopper	2-30
Parallel Interface Kit	A-10
Postcards	A-20
Power Cord Connector	1-4
Power Cord Connector Cover	1-4
Power Switch	1-2
Preprinted Paper	A-21
Print Density	4-49
Print Quality	4-48
Problems	8-3
Print quality problems	
troubleshooting	8-3
Print Resolution	4-49
Printer Driver	2-7
Macintosh	2-10
Windows	2-7
Printer Driver Help	3-5
Printing from Applications	3-2
Prolonged non-use	7-10
R	
RAM Disk	4-81
Rear Cover	1-4
Rear unit	
clearing paper jams	8-23
Recycled paper	A-21
S	
SD/SDHC Memory Card	Glossary-3
Format	4-83
Security	4-96
I/F Block	4-103
Network	4-97
Service Setting	4-128
Specifications	A-23
SSD	A-10, Glossary-3
Format	4-82
Status Menu	6-1
Job Log	6-4
Job Status	6-2
USB Keyboard	6-5
Wireless Network	6-5
Status Page	4-12
T	
Thick Paper	A-21
ThinPrint Option	A-12
TIFF/JPEG Size	4-52
Timer Setting	4-86
Auto error clear	4-91
Auto Panel Reset	4-87
Error Clear Timer	4-92
Form Feed Timeout	4-92
Panel Reset Timer	4-88
Power Off Rule	4-90
Power Off Timer	4-91
Sleep Level	4-88
Sleep Timer	4-90
Toner Alert Level	4-94
Toner Container	1-3
Toner Container Replacement	7-2
Toner Kits	7-2
Top Cover	1-3
Top Tray	1-2
Transparency	A-18
Troubleshooting	8-1
print quality problems	8-3
U	
Uninstalling Software	2-16
USB Interface	1-4
USB Keyboard	A-12
USB KeyboardType	4-94
USB Memory	A-11
Print	4-17
Remove	4-24
USB Memory Slot	1-2
USB Port	1-4

User login setting	4-109
User Name	4-53

W

Waste Toner Box	1-2
Replacing	7-6
Wide A4	4-51
Wireless Network Interface Kit	A-10

X

XPS Fit to Page	4-52
-----------------------	------

**QUALITY
CERTIFICATE**

This machine has passed
all quality controls and
final inspection

KYOCERA Document Solutions America, Inc.**Headquarters**

225 Sand Road,
Fairfield, New Jersey 07004-0008, USA
Phone: +1-973-808-8444
Fax: +1-973-882-6000

Latin America

8240 NW 52nd Terrace Dawson Building, Suite 100
Miami, Florida 33166, USA
Phone: +1-305-421-6640
Fax: +1-305-421-6666

KYOCERA Document Solutions Canada, Ltd.

6120 Kestrel Rd., Mississauga, ON L5T 1S8,
Canada
Phone: +1-905-670-4425
Fax: +1-905-670-8116

**KYOCERA Document Solutions
Mexico, S.A. de C.V.**

Calle Arquimedes No. 130, 4 Piso, Colonia Polanco
Chapultepec, Delegacion Miguel Hidalgo,
Distrito Federal, C.P. 11560, México
Phone: +52-555-383-2741
Fax: +52-555-383-7804

KYOCERA Document Solutions Brazil, Ltda.

Av. Tambore, 1180 Mod.B-09 CEP 06460-000
Tambore-Barueri-SP, Brazil
Phone: +55-11-4195-8496
Fax: +55-11-4195-6167

**KYOCERA Document Solutions
Australia Pty. Ltd.**

Level 3, 6-10 Talavera Road North Ryde N.S.W, 2113,
Australia
Phone: +61-2-9888-9999
Fax: +61-2-9888-9588

**KYOCERA Document Solutions
New Zealand Ltd.**

1-3 Parkhead Place, Albany, Auckland 1330,
New Zealand
Phone: +64-9-415-4517
Fax: +64-9-415-4597

KYOCERA Document Solutions Asia Limited

16/F., Mita Centre, 552-566, Castle Peak Road
Tsuenwan, NT, Hong Kong
Phone: +852-2610-2181
Fax: +852-2610-2063

**KYOCERA Document Solutions
(China) Corporation**

8F, No. 288 Nanjing Road West, Huangpu District,
Shanghai, 200003, China
Phone: +86-21-5301-1777
Fax: +86-21-5302-8300

**KYOCERA Document Solutions
(Thailand) Corp., Ltd.**

335 Ratchadapisek Road, Bangsue, Bangkok 10800,
Thailand
Phone: +66-2-586-0333
Fax: +66-2-586-0278

**KYOCERA Document Solutions
Singapore Pte. Ltd.**

12 Tai Seng Street #04-01A,
Luxasia Building, Singapore 534118
Phone: +65-6741-8733
Fax: +65-6748-3788

**KYOCERA Document Solutions
Hong Kong Limited**

16/F., Mita Centre, 552-566, Castle Peak Road
Tsuenwan, NT, Hong Kong
Phone: +852-2429-7422
Fax: +852-2423-2159

**KYOCERA Document Solutions
Taiwan Corporation**

6F., No.37, Sec. 3, Minquan E. Rd.,
Zhongshan Dist., Taipei 104, Taiwan R.O.C.
Phone: +886-2-2507-6709
Fax: +886-2-2507-8432

KYOCERA Document Solutions Korea Co., Ltd.

18F, Kangnam bldg, 1321-1,
Seocho-Dong, Seocho-Gu, Seoul, Korea
Phone: +822-6933-4050
Fax: +822-747-0084

**KYOCERA Document Solutions
India Private Limited**

First Floor, ORCHID CENTRE
Sector-53, Golf Course Road, Gurgaon 122 002,
India
Phone: +91-0124-4671000
Fax: +91-0124-4671001

KYOCERA Document Solutions Europe B.V.

Bloemlaan 4, 2132 NP Hoofddorp,
The Netherlands
Phone: +31-20-654-0000
Fax: +31-20-653-1256

KYOCERA Document Solutions Nederland B.V.

Beechavenue 25, 1119 RA Schiphol-Rijk,
The Netherlands
Phone: +31-20-5877200
Fax: +31-20-5877260

KYOCERA Document Solutions (U.K.) Limited

8 Beacontree Plaza,
Gillette Way Reading, Berkshire RG2 0BS,
United Kingdom
Phone: +44-118-931-1500
Fax: +44-118-931-1108

KYOCERA Document Solutions Italia S.p.A.

Via Verdi, 89/91 20063 Cernusco s/N.(MI),
Italy
Phone: +39-02-921791
Fax: +39-02-92179-600

KYOCERA Document Solutions Belgium N.V.

Sint-Martinusweg 199-201 1930 Zaventem,
Belgium
Phone: +32-2-7209270
Fax: +32-2-7208748

KYOCERA Document Solutions France S.A.S.

Espace Technologique de St Aubin
Route de l'Orme 91195 Gif-sur-Yvette CEDEX,
France
Phone: +33-1-69852600
Fax: +33-1-69853409

KYOCERA Document Solutions Espana, S.A.

Edificio Kyocera, Avda. de Manacor No.2,
28290 Las Matas (Madrid), Spain
Phone: +34-91-6318392
Fax: +34-91-6318219

KYOCERA Document Solutions Finland Oy

Atomitie 5C, 00370 Helsinki,
Finland
Phone: +358-9-47805200
Fax: +358-9-47805390

**KYOCERA Document Solutions
Europe B.V., Amsterdam (NL) Zürich Branch**

Hohlstrasse 614, 8048 Zürich,
Switzerland
Phone: +41-44-9084949
Fax: +41-44-9084950

**KYOCERA Document Solutions
Deutschland GmbH**

Otto-Hahn-Strasse 12, 40670 Meerbusch,
Germany
Phone: +49-2159-9180
Fax: +49-2159-918100

KYOCERA Document Solutions Austria GmbH

Eduard-Kittenberger-Gasse 95, 1230 Vienna,
Austria
Phone: +43-1-863380
Fax: +43-1-86338-400

KYOCERA Document Solutions Nordic AB

Esbogatan 16B 164 75 Kista, Sweden
Phone: +46-8-546-550-00
Fax: +46-8-546-550-10

KYOCERA Document Solutions Norge Nuf

Postboks 150 Oppsal, 0619 Oslo,
Norway
Phone: +47-22-62-73-00
Fax: +47-22-62-72-00

KYOCERA Document Solutions Danmark A/S

Ejby Industrivej 60, DK-2600 Glostrup,
Denmark
Phone: +45-70223880
Fax: +45-45765850

KYOCERA Document Solutions Portugal Lda.

Rua do Centro Cultural, 41 (Alvalade) 1700-106 Lisboa,
Portugal
Phone: +351-21-843-6780
Fax: +351-21-849-3312

KYOCERA Document Solutions**South Africa (Pty) Ltd.**

49 Kyalami Boulevard,
Kyalami Business Park 1685 Midrand, South Africa
Phone: +27-11-540-2600
Fax: +27-11-466-3050

KYOCERA Document Solutions Russia LLC

Botanichesky pereulok 5, Moscow, 129090,
Russia
Phone: +7(495)741-0004
Fax: +7(495)741-0018

KYOCERA Document Solutions Middle East

Dubai Internet City, Bldg. 17,
Office 157 P.O. Box 500817, Dubai,
United Arab Emirates
Phone: +971-04-433-0412

KYOCERA Document Solutions Inc.

2-28, 1-chome, Tamatsukuri, Chuo-ku
Osaka 540-8585, Japan
Phone: +81-6-6764-3555
<http://www.kyoceradocumentsolutions.com>

